

IN THE UNITED STATES DISTRICT COURT
FOR THE WESTERN DISTRICT OF PENNSYLVANIA

PAWESOME PET PRODUCTS LLC, and
CINDY GHUKASYAN,

Plaintiffs,

v.

DREAMBLISS STORES, BHSMLLT,
DOGGYFUNPLAY, DUOER, EIPGUFILU, EOKOY,
HANWANGWANGBUDIANZISHANGWU, HAPPY
PUPPY UNLIMITED, LLC, HNHCSM, HSHEN,
JINGXINGZESHANGMAOBU, LIHONGJIEDE,
MAIDOUL, MIN YUE SHANG MAO, MOST
WANTED MERCH, MZBOUTIQUES, ROCITA HOME,
SZXBUS, TOYS 4 SPOT, VIVIBEAR, WULILI955,
XIELAIXIXIE, YAOXING, GUANGZHOU KINYU
OUTDOOR PRODUCTS CO., INC., 100%FUNHOME
STORE, ABQP PET STORE, BRAVE FORWARD PETS
STORE STORE, CAT DOG DP STORE, CHHC
GROCERY STORE, CUTE PET SUPPLIER STORE,
DEAR PET HOME STORE, GREATYYT OFFICIAL
STORE, HAPPY XIAOLE STORE, HI PETS STORE, IT
IS YOUR LIFE STORE, KEIDINOLIFE STORE,
KUNPENG PET TOYS STORE, LEAGUE OF PETS
STORE, LOLLIVE STORE, LOVELYPETS STORE,
ME PET CARE STORE, OWNLIFEYF STORE, PETS
HOMES STORE, REFERRAL OFFICER STORE,
RLSOO OFFICIAL STORE OFFICIAL STORE,
SHOP1100227793 STORE, SHOP1100371004 STORE,
SHOP1102094194 STORE, SHOP1102168731 STORE,
SHOP911427269 STORE, SUNFLOWERPET STORE,
SUNYKOI LIFE STORE, SUPER FAR SHOW STORE,
SUPERDEAL STORE, TIANXIASHANHE01 STORE,
TOBEY PETS PRODUCTS STORE, TT PET STORE, V-
LIFE STORE, WARM-HOME STORE,
XINGLONGYUAN STORE, XMPROMO STORE,
YLYC'S LIFE TOGETHER STORE, CHEAPBUNNY,
CHITOWNSTORE, DARWOODS,
MASSIMILIANO235, MORSTA.JNJH5CN, NASON02,
PAULADEH, U_DESERVE, YALGOPALA_0,
BENGBUTIANCHAODIANZISHANGWUYOUXIANG
ONGSI,

Civil Action No.

FILED UNDER SEAL

CHANGLIXIANBULEISHANGMAOYOUXIANGONG
SI, COSARRETY, GF-HUINONG,
GUANGZHOU SHI HUANGDOUKU AJINGMAOYIYO
UXIANGONGSI, HONGRON, LAIDAN,
NINGBOCHANGRONGNONGLINFAZHANYOUXIA
NGONGSI, SAILING INTERNATIONAL TRADING,
SHANGHAIANTUOWANGLUOKEJIYUXIANZERE
NGONGSI, SHENZHEN GUANGYAO MINGHUI
TECHNOLOGY CO., LTD,
SHENZHENSHINANSIYANSHANGMAOYOUXIANG
ONGSI,
SHENZHENSHIYIZHUODIANZIYOUXIANGONGSI,
YICHANGSHICONGTENGDIANZISHANGWUYOUXI
ANGONGSI, LUCY JELERY WORLD

Defendants.

COMPLAINT FOR DAMAGES AND INJUNCTIVE RELIEF

Pawesome Pet Products LLC (“Pawesome”), a Texas corporation, and Cindy Ghukasyan (“Ghukasyan”), an individual (collectively, Pawesome and Ghukasyan are hereinafter referred to as “Plaintiffs”)¹, hereby sue Defendants, the Individuals, Partnerships, and Unincorporated Associations identified in the Caption and which are set forth in **Schedule “A”** hereto (collectively “Defendants”). Defendants have willfully infringed one or more of the claims of U.S. Patent No. 10,477,838 (“Plaintiffs’ Patent” or “the ‘838 patent”) by offering for sale, selling, and distributing knock-off versions of Plaintiffs’ BRISTLY[®] dog toothbrush (“Infringing

¹ Cindy Ghukasyan acquired the Intellectual Property from Petros Dertsakyan. Doggie Dental, Inc. was the former exclusive licensee of the Intellectual Property. Together, Petros Dertsakyan and Doggie Dental, Inc. brought multiple lawsuits related to the facts and claims in this lawsuit and are the predecessors in interest to this lawsuit.

Products”) and therefore bring this single count complaint for patent infringement. In support of their claims, Plaintiffs allege as follows:

NATURE OF THE ACTION

1. In 2016 Petros Dertsakyan developed the idea behind the BRISTLY[®] dog toothbrush. Plaintiffs’ Product is a unique and revolutionary product sold under the BRISTLY[®] trademark (“Plaintiffs’ Mark”) that safely and easily permits dogs to brush their own teeth removing plaque and tartar (“Plaintiffs’ Product”). June 2017 saw the launch of the BRISTLY[®] dog toothbrush for beta testing. Over 50,000 dog owners experienced effortless daily tooth brushing of their dogs with BRISTLY. In June 2018 a crowdfunding campaign was launched on kickstarter.com. In less than two months, \$466,000 was raised with the assistance of nearly 11,000 backers and reached its funding goal in one day; the campaign was featured on the homepage of kickstarter.com as one of its successful campaigns. The crowdfunding campaign was continued on indiegogo.com where an additional \$534,000 was raised with the assistance of over 11,000 additional backers. The crowdfunding campaign for the BRISTLY[®] dog toothbrush is the campaign with the highest number of backers and the highest amount raised of any pet campaigns. The new version of the BRISTLY[®] dog toothbrush went on sale in October 2018 (“Plaintiffs’ Product”). Cindy Ghukasyan is the owner of the intellectual property protecting the Plaintiff’s Product. Pawesome Pet Products LLC is the exclusive licensee of the intellectual property. Together, Cindy Ghukasyan and Pawesome Pet Products LLC are the Plaintiffs in this lawsuit.

2. Defendants have offered for sale, sold, and distributed knock-off versions of the Plaintiffs’ Product which closely mimic the appearance of Plaintiffs’ product and infringe at least one claim of the ‘838 patent. Moreover, Defendants’ sale, distribution, and advertising of the

Infringing Product are highly likely to cause consumers to believe that Defendants are offering a genuine version of Plaintiffs' Product when they are not.

3. Shown below are the four types of Infringing Product offered for sale by the Defendants²:

Plaintiffs' Product



Type 1 Infringing Product



² The evidence supporting this lawsuit indicates that Defendants are selling four of the six Types of Infringing Products sold by Defendants in previous lawsuits brought by Plaintiffs. The Schedule B attached to the Proposed Temporary Restraining Order has been modified to reflect only the four Types identified in this lawsuit.

Plaintiffs' Product



Type 2 Infringing Product



Plaintiffs' Product



Type 3 Infringing Product



Plaintiffs' Product



Type 4 Infringing Product



4. Defendants' actions have resulted in actual confusion in the marketplace between Defendants' Infringing Product and the genuine version of Plaintiffs' Product. Numerous purchasers of Defendants' Infringing Product have contacted Plaintiffs to complain about the performance of the Infringing Product believing same to be a genuine version of Plaintiffs' Product. Examples of such complaints include "my dog destroyed your teeth cleaning thing in 10 seconds" and "I was so worried my dog may have eaten parts of it that I had to check him over at the vet." Such complaints and negative comments are not just made directly to Plaintiffs, but are also posted by members of the public on various websites and social media sites for all the world to see.

5. Defendants' Infringing Products are substantially inferior to the genuine product. Plaintiffs' Product is made of natural rubber. Defendants' Infringing Products are made with silicone or other materials. With poorly designed and manufactured products, Defendants' Infringing Products create serious public safety risks and threaten to destroy the reputation of

high quality that Plaintiffs' Products have earned. A graphic illustration of the significant danger that the Infringing Products present to animals was brought to the attention of Petros Dertsakyan (a predecessor in interest to Plaintiffs) by a pet owner who believed that Doggie Dental (a predecessor in interest to Plaintiffs) sold a faulty and defective product when in actuality the pet owner purchased a knock-off off masquerading as an authentic version of Plaintiffs' Product. The dog had chewed apart the fake product, swallowed a portion, and underwent corrective surgery to remove the piece. The pet owner provided the photographs below.

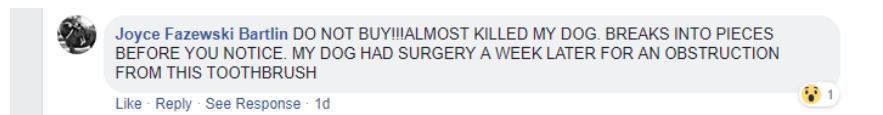
Infringing Product Chewed by Dog



Injured Dog After Surgery



The pet owner wanted Doggie Dental (a predecessor in interest to Plaintiffs) to pay for the damages caused by the fake product. Additionally, the pet owner has previously publicized this post on Doggie Dental's publicly available Facebook page:



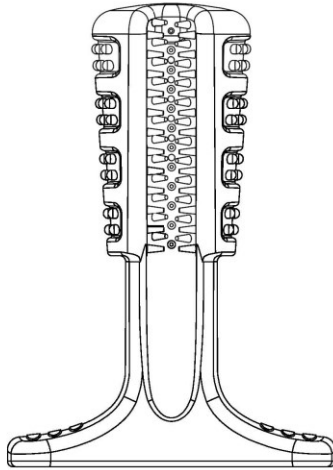
This pet owner's experience and posting highlight both the actual confusion between the Infringing Products and the genuine version of Plaintiffs' Product and the immediate and irreparable injury being incurred by the Plaintiffs.

6. Plaintiffs have taken numerous steps to protect the BRISTLY[®] dog toothbrush. Ghukasyan is the owner of U.S. Trademark Registration No. 5,815,298 for BRISTLY directed to “Non-medicated dental preparations for pets, namely, toothpaste and preparations for removing plaque; Home dental care products for dogs and cats, namely, toothpaste; Dental care and oral hygiene products for pets, namely, tooth cleaning preparations; Non-edible dental chews for pets; Non-medicated oral dental chews for dogs.” A copy of this registration attached hereto as **Exhibit 1**.

7. Ghukasyan is also the owner of U.S. Trademark Registration No. 5,844,832 for BRISTLY directed to “Toothbrushes for animals; Toothbrushes for pets; Home dental care products for dogs and cats, namely, toothbrush.” A copy of this registration attached as **Exhibit 2**.

8. Ghukasyan is the owner of U.S. copyright registration VA 2-122-455 directed to various photographs related to the BRISTLY[™] dog toothbrush (the “Plaintiffs’ Works”). A copy of the copyright registration certificate, together with copies of the deposit materials, is attached hereto as **Exhibit 3**. Ghukasyan is also the owner of unregistered copyrights related to the BRISTLY[®] dog toothbrush.

9. Ghukasyan is also the owner of various design patent applications directed to the BRISTLY[®] dog toothbrush, including an issued European Registered Community Design (005818606-0001), an issued U.S. design patent D 901104, and a pending Chinese design patent application. A copy of the Registered Community Design is attached hereto as **Exhibit 4**. All of the design patent applications have common figures, and one of the figures is set forth below:



10. Ghukasyan is also the owner of U.S. Patent No. 10,477,838 for “Pet chew toy for dental self-cleaning by domestic pets,” which issued on November 19, 2019. A copy of the ‘838 patent is attached hereto as **Exhibit 5**.

11. On information and belief, Defendants’ sale of Infringing Products gives rise to a plausible expectation that discovery will reveal that Defendants’ actions all arise from the same transaction, occurrence, or series of transactions. Specifically, on information and belief, Defendants are actively participating in a conspiracy to distribute and sell Infringing Products. For example, Defendants, on information and belief, are working together to manufacture, arrange the manufacture of and/or sell and otherwise distribute the Infringing Products. Moreover, the Infringing Products all infringe on at least one claim of the Plaintiffs’ Patent and share similar characteristics including, for example, colors, shapes, and sizes.

12. Plaintiffs therefore bring this action for Patent Infringement under 35 U.S.C. § 271, and The All Writs Act, 28 U.S.C. § 1651(a).

JURISDICTION AND VENUE

13. This Court has subject matter jurisdiction over this action pursuant to 28 U.S.C. §§ 1331 and 1338.

14. This Court may exercise personal jurisdiction over a non-resident of the State in which the Court sits to the extent authorized by the state's laws. Fed. R. Civ. P. 4(e). Pennsylvania authorizes personal jurisdiction over each Defendant pursuant to 42 Pa. Cons. Stat. § 5322 (a) which provides in pertinent part: “A tribunal of this Commonwealth may exercise personal jurisdiction over a person ... as to a cause of action or other matter arising from such person: (1) Transacting any business in this Commonwealth. Without excluding other acts which may constitute transacting business for the purpose of this paragraph: (ii) The doing of a single act in this Commonwealth for the purpose of thereby realizing pecuniary benefit ... (3) Causing harm or tortious injury by an act or omission in this Commonwealth. (4) Causing harm or tortious injury by an act or omission outside this Commonwealth ... (10) Committing any violation within the jurisdiction of the Commonwealth of any statute, home rule charter, local ordinance or resolution, or rule or regulation promulgated thereunder by any government unit or of any order of court or other government unit.” In the alternative, Federal Rule of Civil Procedure 4(k) confers personal jurisdiction over the Defendants because, upon information and belief, Defendants regularly conduct, transact and/or solicit business in Pennsylvania and in this judicial district, and/or derive substantial revenue from their business transactions in Pennsylvania and in this judicial district and/or otherwise avail themselves of the privileges and protections of the laws of the Commonwealth of Pennsylvania such that this Court's assertion of jurisdiction over Defendants does not offend traditional notions of fair play and due process, and/or Defendants' illegal counterfeiting and infringing actions caused injury to Plaintiffs in

Pennsylvania and in this judicial district such that Defendants should reasonably expect such actions to have consequences in Pennsylvania and in this judicial district, for example:

a. Upon information and belief, at all times relevant hereto, Defendants were and/or are systematically directing and/or targeting their business activities at consumers in the United States, including Pennsylvania, through on-line platforms with Merchant Storefronts (as defined *infra*), via on-line marketplace websites, such as Amazon.com, eBay.com, Aliexpress.com, Walmart.com, and Wish.com, under the Seller IDs, as well as any and all as yet undiscovered accounts with Merchant Storefronts held by or associated with Defendants, their respective officers, employees, agents, servants and all persons in active concert or participation with any of them (“User Accounts”), through which consumers in the United States, including Pennsylvania, can view the one or more of Defendants’ Merchant Storefronts that each Defendant operates, uses to communicate with Defendants regarding their listings for Infringing Products and to place orders for, receive invoices for and purchase Infringing Products for delivery in the U.S., including Pennsylvania, as a means for establishing regular business with the U.S., including Pennsylvania.

b. Upon information and belief, certain Defendants are sophisticated sellers, each operating one or more commercial businesses using their respective User Accounts through which Defendants, their respective officers, employees, agents, servants and all persons in active concert of participation with any of them, operate storefronts to manufacture, import, export, advertise, market, promote, distribute, offer for sale and/or otherwise deal in products, including the Infringing Products, which are held by or associated with Defendants, their respective officers, employees, agents, servants and all

persons in active concert or participation with any of them (“Merchant Storefront(s)”) in wholesale quantities at significantly below-market prices to consumers worldwide, including to those in the U.S., and specifically Pennsylvania.

c. Upon information and belief, Defendants’ Merchant Storefronts reflect multiple sales to consumers all over the world, including repeat sales to consumers in the U.S. and into this judicial district.

d. Upon information and belief, all Defendants accept payment in U.S. Dollars and offer shipping to the U.S., including to Pennsylvania.

e. Upon information and belief, at all times relevant, Defendants have transacted business with consumers located in the U.S., including Pennsylvania, for the sale and shipment of Infringing Products.

f. Upon information and belief, Defendants are employing and benefiting from substantially similar, paid advertising and marketing and advertising strategies in order to make their Merchant Storefronts selling illegal goods appear more relevant and attractive to search result software across an array of search words, including but not limited to “BRISTLY”, and “WORLD’S MOST EFFECTIVE DOG TOOTHBRUSH”. By their actions, Defendants are causing concurrent and indivisible harm to Plaintiffs and the consuming public by (i) depriving Plaintiffs of their right to fairly compete for space within the various on-line marketplace search results and reducing the visibility of the Plaintiffs’ Product on various on-line marketplaces and/or diluting and driving down the retail market price for the Plaintiffs’ Product (ii) causing an overall degradation of the value of the goodwill associated with Plaintiffs’ Marks and Plaintiffs’ Product; and (iii)

increasing Plaintiffs' overall cost to market its goods and educate consumers about its brand and products.

g. Upon information and belief, Defendants have cooperated, communicated their plans with one another, shared information, and coordinated their efforts, all in order to create an illegal marketplace operating in parallel to the legitimate marketplace of Plaintiffs' and the legally authorized resellers of Plaintiffs' genuine goods.

h. Upon information and belief, Defendants are concurrently targeting their infringing activities toward consumers and causing harm in Allegheny County, Pennsylvania.

i. Upon information and belief, most of the Defendants likely reside and/or operate in foreign jurisdictions with lax trademark and patent enforcement systems and are cooperating by creating an illegal stream of infringing and counterfeit goods.

j. Upon information and belief, Defendants are aware of Plaintiffs, their genuine BRISTLY® dog toothbrush product, and are aware that their illegal infringing actions alleged herein are likely to cause injury to Plaintiffs in the United States, in Pennsylvania and in this judicial district specifically, as Plaintiffs conducts substantial business in Pennsylvania.

k. Plaintiffs are suffering irreparable and indivisible injury and suffered substantial damages as a result of Defendants' unauthorized and wrongful sale of counterfeit and infringing goods.

15. Venue is proper, *inter alia*, pursuant to 28 U.S.C. § 1391 because, for example:

a. Upon information and belief, Defendants conduct, transact, and/or solicit business in this judicial district.

b. Upon information and belief, Defendants or their agent(s) may be found in this district because personal jurisdiction is proper in this district.

c. Upon information and belief, this is a judicial district in which a substantial part of the events or omissions giving rise to the infringement claims occurred, or a substantial part of the property that is the subject of the action is situated.

d. Defendants not resident in the United States may be sued in this judicial district because personal jurisdiction is proper in this district.

THE PLAINTIFFS

16. Plaintiff Pawesome Pet Products LLC (“Pawesome”) is a Texas limited liability company and has a mailing address of 2004 Stirling Street, Leander, Texas 78641. Pawesome is the exclusive licensee of the intellectual property relating to the BRISTLY® dog toothbrush.

17. Plaintiff Cindy Ghukasyan (“Ghukasyan”) is an individual who resides in Texas and has a mailing address of 2004 Stirling Street, Leander, Texas 78641. She is the owner of the intellectual property related to the BRISTLY® dog toothbrush.

18. Pawesome is, in part, engaged in the business of manufacturing and distributing throughout the world, including within this district, the BRISTLY® dog toothbrush, through its website, bristly.com, its authorized seller on amazon.com, and various retail establishments, including Petsense. Defendants, through the sale and offer to sell Infringing Products are directly, and unfairly, competing with Plaintiffs’ economic interest in the Commonwealth of Pennsylvania and causing Plaintiffs harm within this jurisdiction.

19. Like many other brand owners, Plaintiffs suffer ongoing daily and sustained violations of their rights at the hands of infringers, such as Defendants herein, who wrongfully reproduce Plaintiffs' Products for the twin purposes of (i) duping and confusing the consuming public and (ii) earning substantial profits from the sale of their Infringing Products. The natural and intended byproduct of Defendants' actions is the erosion and destruction of the goodwill associated with Plaintiffs' Products and the destruction of the legitimate market sector in which Plaintiffs operate.

20. The recent explosion of counterfeiting and infringement over the Internet, including through online marketplace platforms, has created an environment that requires brand owners, such as Plaintiffs, to expend significant time and money across a wide spectrum of efforts in order to protect both consumers and Plaintiffs from the ill effects of confusion and the erosion of the goodwill associated with Plaintiffs' brand and products.

THE DEFENDANTS

21. The Defendants are individuals and/or business entities of unknown makeup, each of whom, upon information and belief, either reside or operate in foreign jurisdictions, or (though not foreign)³ redistribute products from the same or similar sources in those locations.

Defendants have the capacity to be sued pursuant to Federal Rule of Civil Procedure 17(b).

³ Prior to filing this lawsuit, Plaintiffs viewed a public seller profile that is published by certain Defendant's storefronts that purports to identify the name and address of the Defendant. Solely based upon their representation on their storefronts, the following defendants have identified themselves as US-based and are not at this time alleged to be foreign sellers: CHITOWNSTORE, COSARRETY, DARWOODS, DOGGYFUNPLAY, DREAMBLISS STORES, HAPPY PUPPY UNLIMITED, LLC, MASSIMILIANO235, MORSTA.JNJH5CN, MOST WANTED MERCH, NASON02, PAULADEH, SAILING INTERNATIONAL TRADING, TOYS 4 SPOT, U_DESERVE, YALGOPALA_0.

Defendants target their business activities toward consumers throughout the United States, including within this district, and conduct pervasive business through the operation of, at least, one fully interactive commercial Internet based e-commerce store via, at least, the Internet based online marketplaces Amazon.com, ebay.com, aliexpress.com, Walmart.com, and wish.com, all under the Seller IDs.

22. Upon information and belief, the Defendants use aliases in conjunction with the operation of their businesses as set forth in **Schedule "A"** hereto.

23. Defendants are the past and present controlling forces behind the sale of products infringing at least one claim of the '838 patent described herein using at least the Seller IDs.

24. Upon information and belief, Defendants directly engage in unfair competition with Plaintiffs and their authorized resellers by willfully advertising, offering for sale and selling goods infringing upon at least one claim of the '838 patent to consumers within the United States and this district through several fully interactive, commercial Internet websites and Internet based e-commerce stores operating under, at least, the storefronts, the Seller IDs, and any additional domain names, websites and corresponding website URLs or seller identifications and store URL aliases not yet known to Plaintiffs. Defendants have purposefully directed some portion of their illegal activities towards consumers in the Commonwealth of Pennsylvania through the advertisement, offer to sell, sale, and/or shipment of Infringing Products into the Commonwealth.

25. Defendants have registered, established or purchased, and maintained the on-line marketplace website storefronts and Seller IDs. Upon information and belief, Defendants have engaged in fraudulent conduct with respect to the registration of the storefronts and Seller IDs by providing false and/or misleading information to the Internet based e-commerce platforms where

they offer for sale and/or sell, during the registration or maintenance process related to their respective Seller ID. Upon information and belief, Defendants have anonymously registered and maintained some of the Seller IDs for the sole purpose of engaging in illegal infringing activities.

26. Upon information and belief, Defendants will continue to register or acquire new seller identification aliases for the purpose of selling and offering for sale goods infringing at least one claim of the '838 patent unless preliminarily and permanently enjoined.

27. Defendants' Internet-based businesses amount to nothing more than illegal operations established and operated in order to infringe the intellectual property rights of Plaintiffs.

28. Defendants' business names, i.e., the Seller IDs, associated payment accounts, and any other alias seller identification names used in connection with the sale of goods infringing on at least one claim of the '838 patent are essential components of Defendants' online activities and are the means by which Defendants further their infringement scheme and cause harm to Plaintiffs.

COMMON FACTUAL ALLEGATIONS

Plaintiffs and Their BRISTLY Dog Toothbrush

29. Plaintiffs' predecessors in interest developed and sell a unique and revolutionary product under their registered trademark BRISTLY® ("Plaintiffs' Mark") that safely and easily permits dogs to brush their own teeth removing plaque and tarter ("Plaintiffs' Product").

Plaintiffs' predecessors in interest identified the need for this product and created the market for this product. Below is an image of one of Plaintiffs' Products, which retails for \$16.99:



The Plaintiffs' Mark is inherently distinctive, as recognized by the U.S. Patent and Trademark Office in issuing two trademark registrations on the Principal Register.

30. On November 19, 2019, the U.S. Patent and Trademark Office issued the '838 patent, the claims of which protect Plaintiffs' Product. The '838 patent has never been assigned or licensed to any of the Defendants in this matter. Plaintiffs have provided constructive notice of the '838 patent by placing the patent number of the '838 patent on the packaging of Plaintiffs' Product and/or their website. At all times relevant hereto, the Defendants had notice of the Plaintiff's Patent.

31. Plaintiffs' Bristly product has been featured in videos or articles by numerous media outlets, including MSN (<https://www.msn.com/en-sg/lifestyle/lifestylegeneral/a-new-chew-toy-will-help-your-dog-brush-its-own-teeth/ar-AAA8pvh>) , Pet Lover Geek (<https://www.facebook.com/petlovergeek/videos/613996128985404>), Askmen (https://www.askmen.com/entertainment/guy_gear/best-new-kickstarters-for-june-28-2018.html), Interesting Engineering (<https://interestingengineering.com/this-chew-stick-for-dogs-helps-them-achieve-good-oral-health>), Awesome Stuff 365 (<https://awesomestuff365.com/bristly-toothbrush-for-dogs/>), star2.com (<https://www.star2.com/living/2018/07/28/toothbrushing-stick-dogs-clean-teeth/>), Dude (<http://www.dudeiwantthat.com/household/pets/bristly-toothbrush-for-dogs.asp>), Gaget flow (<https://thegadgetflow.com/blog/bristly-is-the-chew-toy-that-cleans-your-dogs-teeth/>) and

<https://thegadgetflow.com/portfolio/dog-tooth-brushing-stick/>), The Gadgeteer (<https://the-gadgeteer.com/2018/07/20/micro-veggie-growing-tray-tiny-edc-pen-a-toothbrush-for-dogs-and-more-notable-crowdfunding-campaigns/>), Steemit (<https://steemit.com/steemhunt/@adarshagni/bristly-chew-stick-for-dogs>), New Atlas (<https://newatlas.com/bristly-dog-toothbrush/55401/>), TheThings.com (<https://www.thethings.com/chew-toy-helps-dogs-brush-teeth>), slashpets (<https://www.slashpets.com/bristly-toothbrush/>), Cool Business Ideas (<https://www.coolbusinessideas.com/archives/toothbrush-for-your-doggy/>), Cool Hunting (<https://coolhunting.com/design/bristly-dog-toothbrush/>), MNN (<https://www.mnn.com/family/pets/stories/answer-dog-toothbrushing-struggle>), Gismo Review (<https://www.gismoreview.com/bristly-the-toothbrush-for-dog/>), Product Watch (<https://productwatch.co/hate-brushing-your-dogs-teeth-meet-bristly-and-forget-your-tribbles/>), Mental Floss (<http://mentalfloss.com/article/551054/new-chew-toy-will-help-your-dog-brush-its-own-teeth>), and Trend Hunter (<https://www.trendhunter.com/trends/bristly>).

Defendants' Wrongful and Infringing Conduct

32. Upon information and belief, Defendants are, through at least the Internet based e-commerce stores operating under the Seller IDs, promoting, selling, offering for sale and distributing goods that willfully infringe at least one claim of the '838 patent while marketing their patent-infringing products in a willful attempt to pass off their knock-off products as the genuine version of Plaintiffs' Products.

33. Upon information and belief, Defendants' Infringing Products are of a quality substantially and materially different than that of Plaintiffs' genuine goods. Defendants, upon information and belief, are actively using, promoting and otherwise advertising, distributing,

selling, and/or offering for sale substantial quantities of their Infringing Products with the knowledge and intent that such goods will be mistaken for the genuine high quality goods offered for sale by Plaintiffs despite Defendants' knowledge that they are without authority to use the subject matter of the '838 patent.

34. Defendants advertise their Infringing Products for sale to the consuming public via Internet based e-commerce stores on, at least, one Internet marketplace on Amazon.com, eBay.com, Aliexpress.com, Walmart.com, and Wish.com, using at least the Seller IDs. In so advertising these goods, Defendants improperly and unlawfully infringe at least one claim of the '838 patent without Plaintiffs' permission.

35. As part of their overall infringement scheme, Defendants are, upon information and belief, concurrently employing and benefitting from substantially similar, advertising and marketing strategies based, in large measure, upon an illegal use of infringements of the '838 patent in order to make their e-commerce stores selling illegal goods appear more relevant and attractive to consumers online. By their actions, Defendants are contributing to the creation and maintenance of an illegal marketplace operating in parallel to the legitimate marketplace for Plaintiffs' genuine goods. Defendants are causing individual, concurrent and indivisible harm to Plaintiffs and the consuming public by (i) depriving Plaintiffs and other third parties of their right to fairly compete for space within search engine results and reducing the visibility of Plaintiffs' genuine goods on the World Wide Web, (ii) causing actual consumer confusion, (iii) harm to Plaintiffs' reputations, including tarnishing their status as the innovator in this market, (iv) an overall degradation of the value of the goodwill associated with the Plaintiffs' brand, and (v) increasing Plaintiffs' overall cost to market its goods and educate consumers about its brand via the Internet.

36. Plaintiffs confirmed that Defendants were and/or are still currently offering for sale and/or selling Infringing Products for sale to the consuming public via Internet based e-commerce stores on, at least, one Internet marketplace using at least the Seller IDs and that Defendants provide shipping and/or have actually shipped Infringing Products to customers located within this judicial district.

37. There is no question that the Infringing Product itself and the manner in which it is marketed is designed to confuse and mislead consumers into believing that they are purchasing Plaintiffs' Product or that the Infringing Product is otherwise approved by or sourced from Plaintiffs, thereby trading on the goodwill and reputation of Plaintiffs.

38. Upon information and belief, at all times relevant hereto, Defendants in this action had full knowledge of Plaintiffs' ownership of the '838 patent. Plaintiffs' Product was properly marked and identified as protected by the Plaintiff's Patent. Defendants' use of the '838 patent is without Plaintiffs' consent or authorization.

39. Defendants are engaging in the above-described illegal infringing activities knowingly and intentionally or with reckless disregard or willful blindness to Plaintiffs' rights for the purpose of infringing the '838 patent and trading on Plaintiffs' goodwill and reputation. If Defendants' intentional infringing activities are not preliminarily and permanently enjoined by this Court, Plaintiffs and the consuming public will continue to be harmed.

40. Defendants above identified infringing activities are likely to cause confusion, deception, and mistake in the minds of consumers before, during, and after the time of purchase. Moreover, Defendants' wrongful conduct is likely to create a false impression and deceive

customers, the public, and the trade into believing there is a connection or association between Plaintiffs' Products and Defendants' Infringing Products, which there is not.

41. Upon information and belief, Defendants' payment and financial accounts are being used by Defendants to accept, receive, and deposit profits from Defendants' infringing and unfairly competitive activities connected to their Seller IDs and any other alias e-commerce stores, photo albums, seller identification names, domain names, or websites being used and/or controlled by them.

42. Further, upon information and belief, Defendants are likely to transfer or secret their assets to avoid payment of any monetary judgment awarded to Plaintiffs.

43. Plaintiffs have no adequate remedy at law.

44. Plaintiffs are suffering irreparable injury and have suffered substantial damages as a result of Defendants' unauthorized and wrongful infringement of at least one claim of the '838 patent. If Defendants' infringing activities are not preliminarily and permanently enjoined by this Court, Plaintiffs and the consuming public will continue to be harmed.

45. The harm and damages sustained by Plaintiffs have been directly and proximately caused by Defendants' wrongful reproduction, use, advertisement, promotion, offers to sell, and sale of their Infringing Products.

COUNT I – PATENT INFRINGEMENT (35 U.S.C. § 271 (a))

46. Plaintiffs hereby adopt and re-allege the allegations set forth in the preceding paragraphs as if set forth herein.

47. Plaintiffs are the owner of U.S. Patent No. 10,477,838 B2 (“the ‘838 Patent”), issued November 19, 2019, for “PET CHEW TOY FOR DENTAL SELF-CLEANING BY

DOMESTIC PETS” and which covers Plaintiffs’ Product. A true and correct copy of which is attached as **Exhibit 5**.

48. The Accused Type 1-4 Products infringe at least Claim 1 of the ‘838 patent, as more fully detailed in **Exhibits 6-9**, respectively.

49. Defendants have infringed and continue to infringe the ‘838 patent either directly or indirectly through acts of contributory infringement or inducement in violation of 35 U.S.C. § 271, by making, using, selling, importing and/or offering to sell Infringing Products, namely the pet toothbrushes that are nearly identical to Plaintiffs’ Product.

50. Defendants’ infringement, contributory infringement and/or inducement to infringe has injured Plaintiffs and they, therefore, is entitled to recover damages adequate to compensate it for such infringement, but in no event less than a reasonable royalty.

51. Defendants’ infringement, contributory infringement and/or inducement to infringe has been willful and deliberate because Defendants have notice of or knew of the ‘838 patent and have nonetheless injured and will continue to injure Plaintiff, unless and until this Court enters an injunction, which prohibits further infringement and specifically enjoins further manufacture, use, sale, importation and/or offer for sale of products or services that come within the scope of the ‘838 patent.

52. Based on Defendants’ wrongful conduct, Plaintiff is entitled to injunctive relief as well as monetary damages and other remedies as provided by the Patent Act, including damages that Plaintiff has sustained and will sustain as a result of Defendants’ illegal and infringing actions as alleged herein, enhanced discretionary damages and reasonable attorneys’ fees and costs.

PRAYER FOR RELIEF

WHEREFORE, Plaintiffs demands judgment on all Counts of this Complaint and an award of equitable relief and monetary relief against Defendants as follows:

a. Entry of temporary, preliminary and permanent injunctions pursuant to 35 U.S.C. § 283, and Federal Rule of Civil Procedure 65 enjoining Defendants, their agents, representatives, servants, employees, and all those acting in concert or participation therewith, from manufacturing or causing to be manufactured, importing, advertising or promoting, distributing, selling or offering to sell their Infringing Products;

b. Entry of an Order that, upon Plaintiffs' request, any Internet marketplace website operators and/or administrators that are provided with notice of the injunction, including but not limited to the online marketplaces hosted by Amazon.com, eBay.com, Aliexpress.com, Walmart.com, and Context Logic, Inc. d/b/a wish.com, identify any e-mail address known to be associated with Defendants' respective Seller ID, and cease facilitating access to any or all e-commerce stores through which Defendants engage in the promotion, offering for sale, and/or sale of Infringing Products.

c. Entry of an Order that, upon Plaintiffs' request, any Internet marketplace website operators and/or administrators who are provided with notice of the injunction, including but not limited to online marketplaces hosted by Amazon.com, eBay.com, Aliexpress.com, Walmart.com, and Context Logic, Inc. d/b/a wish.com permanently remove any and all listings offering for sale Infringing Products via the e-commerce stores operating under the Seller IDs, including any and all listings linked to the same seller or linked to any other alias seller identification name being used and/or controlled by Defendants to promote, offer for sale and/or sell Infringing Products.

d. Entry of an Order that, upon Plaintiffs' request, any Internet marketplace website operators and/or administrators who are provided with notice of the injunction, including but not limited to online marketplaces hosted by at least one of Amazon.com, eBay.com, Aliexpress.com, Walmart.com, and Context Logic, Inc. d/b/a wish.com, immediately cease fulfillment of and sequester all goods of each Defendant or other Seller under a Seller ID offering for sale the Infringing Product in its inventory, possession, custody, or control, and surrender those goods to Plaintiffs.

e. Entry of an order awarding Plaintiffs damages adequate to compensate for the infringement of its patent, but in no event less than a reasonable royalty for the use made of the invention by the Defendants, together with interest and costs as fixed by the Court pursuant to 35 U.S.C. § 284 and that the award be trebled as provided for under 35 U.S.C. §284.

f. Entry of an Order finding that this case is exceptional and an award to Plaintiffs of its attorney fees and costs as provided by for under 35 U.S.C. § 285.

g. Entry of an Order that, upon Plaintiffs' request, any financial institutions, payment processors, banks, escrow services, money transmitters, or marketplace platforms, including but not limited to, Zhejiang Ant Small and Micro Financial Services Group Co., Ltd. AliPay (China) Internet Technology Co. Ltd., and Alipay.com Co., Ltd. (collectively referred to as "AliPay")⁴, Amazon Payments, Inc., PayPal, Inc. d/b/a paypal.com, Walmart Pay operated by Wal-Mart.com USA, LLC, and Context Logic, Inc. d/b/a wish.com, or marketplace platforms, including but not limited to, Amazon.com, ebay.com, aliexpress.com, Walmart.com, and Context Logic, Inc d/b/a

⁴ WorldPay US, Inc. ("WorldPay") processes transactions on behalf of Alibaba and Alipay, which may appear as "Aliexpress" on a cardholder's credit card statement.

wish.com, and their related companies and affiliates, identify and restrain all funds, up to and including the total amount of judgment, in all financial accounts and/or sub-accounts used in connection with the Seller IDs or other domain names, alias seller identification names, or e-commerce store names or store URLs used by Defendants presently or in the future, as well as any other related accounts of the same customer(s) and any other accounts which transfer funds into the same financial institution account(s), to be surrendered to Plaintiffs in partial satisfaction of the monetary judgment entered herein.

- h. Entry of an award of pre- and post-judgment interest on the judgment amount.
- i. Entry of an order for any further relief as the Court may deem just and proper.

DEMAND FOR JURY TRIAL

Plaintiffs respectfully demand a trial by jury on all claims.

Respectfully submitted,

November 9, 2022

/s/ Stanley D. Ference III

Stanley D. Ference III

Pa. ID No. 59899

courts@ferencelaw.com

Brian Samuel Malkin

Pa. ID No. 70448

bmalkin@ferencelaw.com

FERENCE & ASSOCIATES LLC

409 Broad Street

Pittsburgh, Pennsylvania 15143

(412) 741-8400 - Telephone

(412) 741-9292 - Facsimile

Attorneys for Plaintiffs

PAWESOME PET PRODUCTS LLC, and

CINDY GHUKASYAN

Schedule “A”

Defendants With Store Name and Seller ID

Defendant Number	Seller ID/Store	ASIN
1	Dreambliss stores	A18U48J9OM5PF3
2	bhsmllt	A31OPD7QJQIIM1
3	DoggyFunPlay	A1O48T814RY9TC
4	duoer	A3TEJPE4GLCVAG
5	eipgufILU	A39PWGMV8JH4O
6	eokoy	A2D1N323YLILS
7	hanwangwangbudianzishangwu	A2C8AI7ALRQWP9
8	Happy Puppy Unlimited, LLC	A3KHYU4ZTMVEZS
9	hnhesm	A2EK5YEE5DWEMR
10	Hshen	A2LQZW00C1HYQS
11	jingxingzeshangmaobu	A233GLQMJ9GBU1
12	lihongjiede	A28R9UZEWWPGWC
13	Maidoul	A2IK8WH054SEFZ
14	Min Yue Shang Mao	A13NGEFRMB3EHP
15	Most Wanted Merch	ADM5A2BNDZZX8
16	MZBoutiques	AAPDG0QHCKVN7
17	Rocita Home	A3IZ3Q8N7J07P3
18	SZXBUS	ALL3AH0LRSXGF
19	Toys 4 Spot	A2PQ9FYWW2L5NC
20	ViviBear	A2LOPLW7UTR9QQ
21	wulili955	AXO28SXGK8CO2
22	xielaixixie	A2HEREZ98NE8JP
23	Yaoxing	A10HI6LUDCHJA4
24	Guangzhou Kinyu Outdoor Products Co., Inc.	1600201372177
25	100%Funhome Store	1101817337
26	ABQP PET Store	1101776386
27	Brave Forward Pets store Store	1102128731
28	CAT DOG DP Store	1102132073
29	CHHC Grocery Store	1102029069
30	CutePet Supplier Store	1101688980
31	Dear Pet Home Store	1100925449
32	GREATYYT Official Store	1101585683
33	happy xiaole Store	1102038655
34	Hi Pets Store	1101569600
35	It Is Your Life Store	1101804626
36	keidinolife Store	1102209627

37	Kunpeng Pet Toys Store	1102178187
38	League of Pets Store	1101322760
39	LOLlive Store	1101706698
40	LovelyPets Store	1101880608
41	ME Pet Care Store	1102058877
42	OwnLifeYF Store	1101665639
43	Pets Homes Store	1101332164
44	Referral officer Store	1101564239
45	RLSOO official store Official Store	1101880429
46	Shop1100227793 Store	1102025168
47	Shop1100371004 Store	1102050849
48	Shop1102094194 Store	1102085250
49	Shop1102168731 Store	1102166875
50	Shop911427269 Store	1101620817
51	Sunflowerpet Store	1101528663
52	SUNYKOI Life Store	1101438600
53	Super Far Show Store	1101281385
54	SuperDeal Store	1101460314
55	tianxiashanhe01 Store	1102011911
56	Tobey Pets Products Store	1101798639
57	TT PET Store	1101985115
58	V-Life Store	1101568644
59	warm-home Store	1101396878
60	xinglongyuan Store	1101363147
61	Xmpromo Store	1101193098
62	Ylyc's Life Together Store	1101358370
63	cheapbunny	125525895763
64	chitownstore	265234150290
65	darwoods	115477676837
66	massimiliano235	233682894938
67	morsta.jnjh5cn	284060570573
68	nason02	362996898106
69	pauladeh	144121813777
70	u_deserve	184386349995
71	yalgopala_0	385068727298
72	bengbutianchao dianzishangwuyouxiangongsi	101191125
73	changlixianbuleishangmaoyouxiangongsi	101210283
74	COSARRETY	101055903
75	GF-Huinong	101175048
76	Guangzhoushihuangdoukuajingmaoyiyouxiangongsi	101182353
77	HONGRON	101195583
78	Laidan	101130950
79	ningbochangrongnonglinfazhanyouxiangongsi	101188698

80	Sailing International Trading	101062286
81	shanghaiantuowangluokejiyouxianzerengongsi	101191914
82	Shenzhen Guangyao Minghui Technology Co., Ltd	101211131
83	ShenZhenShiYiZhuoDianZiYouXianGongSi	101224522
84	YICHANGSHICONGTENGDIANZISHANGWUYOUXIANG ONGSI	101231955
85	Lucy Jelery World	5d4583a070327a1e80f07542

LISTING OF EXHIBITS

- Exhibit 1U.S. Trademark Reg. No. 5,815,298 for BRISTLY
- Exhibit 2U.S. Trademark Reg. No. 5,844,832 for BRISTLY
- Exhibit 3U.S. Copyright Reg. No. VA 2-122-455 for “Photos of In Use
Pet/Dog Toy for Oral Hygiene”
- Exhibit 4European Registered Community Design No. 005818606-0001
- Exhibit 5U.S. Patent No. 10,477,838
- Exhibit 6Comparison of Type 1 Infringing Product to claim 1 of U.S. Patent
No. 10,477,838
- Exhibit 7Comparison of Type 2 Infringing Product to claim 1 of U.S. Patent
No. 10,477,838
- Exhibit 8Comparison of Type 3 Infringing Product to claim 1 of U.S. Patent
No. 10,477,838
- Exhibit 9Comparison of Type 4 Infringing Product to claim 1 of U.S. Patent
No. 10,477,838

EXHIBIT 1

United States of America

United States Patent and Trademark Office

BRISTLY

Reg. No. 5,815,298

Registered Jul. 23, 2019

Int. Cl.: 3

Trademark

Principal Register

Dertsakyan, Peter (UNITED STATES INDIVIDUAL)
7700 Babcock Ave
North Hollywood, CALIFORNIA 91605

CLASS 3: Non-medicated dental preparations for pets, namely, toothpaste and preparations for removing plaque; Home dental care products for dogs and cats, namely, toothpaste; Dental care and oral hygiene products for pets, namely, tooth cleaning preparations; Non-edible dental chews for pets; Non-medicated oral dental chews for dogs

FIRST USE 6-00-2018; IN COMMERCE 6-00-2018

THE MARK CONSISTS OF STANDARD CHARACTERS WITHOUT CLAIM TO ANY PARTICULAR FONT STYLE, SIZE OR COLOR

SER. NO. 88-177,120, FILED 10-31-2018



Andrei Iancu

Director of the United States
Patent and Trademark Office

EXHIBIT 2

United States of America

United States Patent and Trademark Office

BRISTLY

Reg. No. 5,844,832

Registered Aug. 27, 2019

Int. Cl.: 21

Trademark

Principal Register

Dertsakyan, Peter (UNITED STATES INDIVIDUAL)
7700 Babcock Ave
North Hollywood, CALIFORNIA 91605

CLASS 21: Toothbrushes for animals; Toothbrushes for pets; Home dental care products for dogs and cats, namely, toothbrush

FIRST USE 2-1-2017; IN COMMERCE 2-1-2017

THE MARK CONSISTS OF STANDARD CHARACTERS WITHOUT CLAIM TO ANY PARTICULAR FONT STYLE, SIZE OR COLOR

SER. NO. 88-310,557, FILED 02-21-2019



Andrei Iancu

Director of the United States
Patent and Trademark Office

EXHIBIT 3

Certificate of Registration



This Certificate issued under the seal of the Copyright Office in accordance with title 17, *United States Code*, attests that registration has been made for the work identified below. The information on this certificate has been made a part of the Copyright Office records.

Kay A. Leigh

Acting United States Register of Copyrights and Director

Registration Number

VA 2-122-455

Effective Date of Registration:

September 27, 2018

Title

Title of Work: Photos of In Use Pet/Dog Toy For Oral Hygiene

Completion/Publication

Year of Completion: 2018
Date of 1st Publication: June 20, 2018
Nation of 1st Publication: United States

Author

◦ Author: Petros Dertsakyan
Author Created: photograph, 2-D artwork
Citizen of: United States
Domiciled in: United States
Year Born: 1987

Copyright Claimant

Copyright Claimant: Petros Dertsakyan
7700 Babcock Ave., North Hollywood, CA, 91605, United States
Transfer statement: author is claimant

Limitation of copyright claim

Material excluded from this claim: sculpture
New material included in claim: photograph, 2-D artwork

Rights and Permissions

Organization Name: David R. Preston, Ph.D., J.D., APC
Name: David Preston
Email: preston@drpna.com
Telephone: (858)724-0375
Alt. Telephone: (858)735-7132

Address: 10765 Wallingford Road
San Diego, CA 92126 United States

Certification

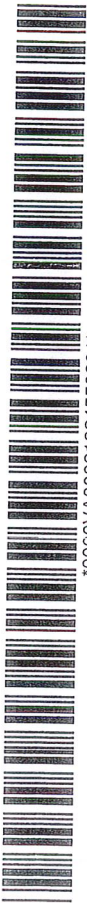
Name: David R. Preston
Date: September 27, 2018
Applicant's Tracking Number: DOGD-106.C.3

Correspondence: Yes
Copyright Office notes: Basis for Registration: Unit of publication



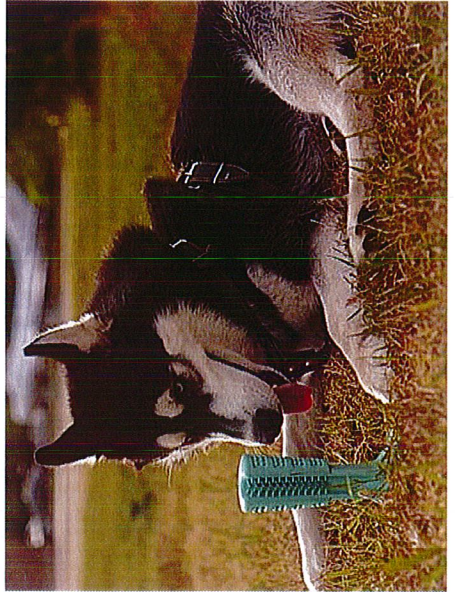
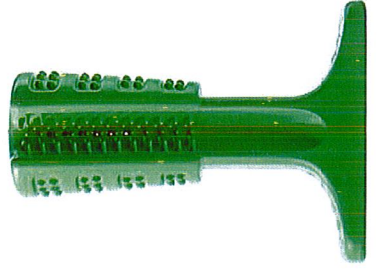
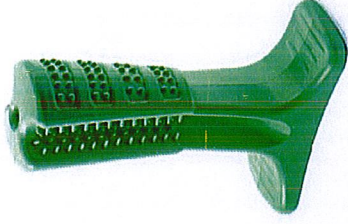
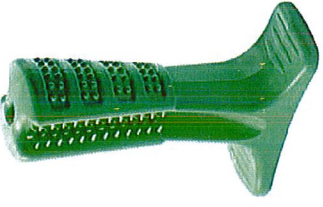
Registration #: VA0002122455
Service Request #: 1-6990498131

David R. Preston, Ph.D., J.D., APC
David Preston
10765 Wallingford Road
San Diego, CA 92126 United States

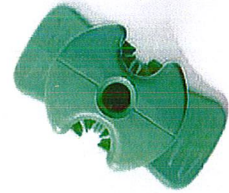
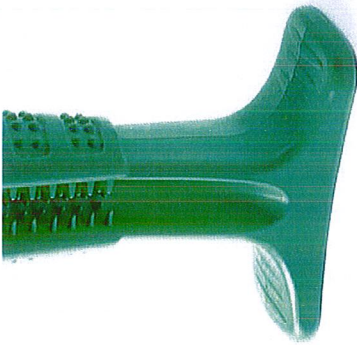
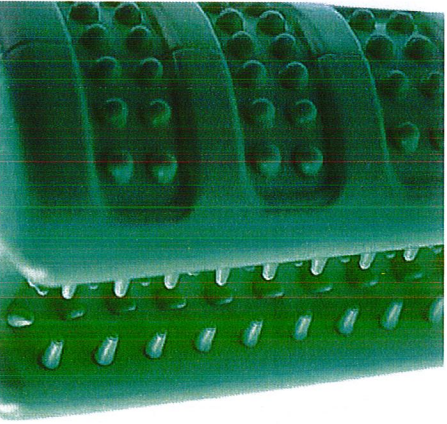
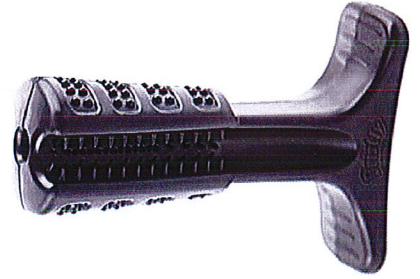
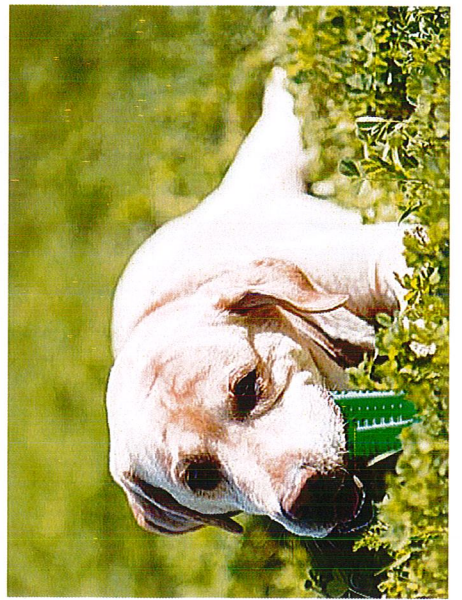
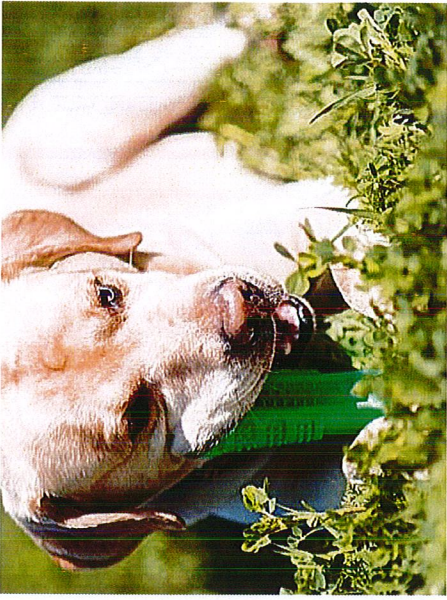


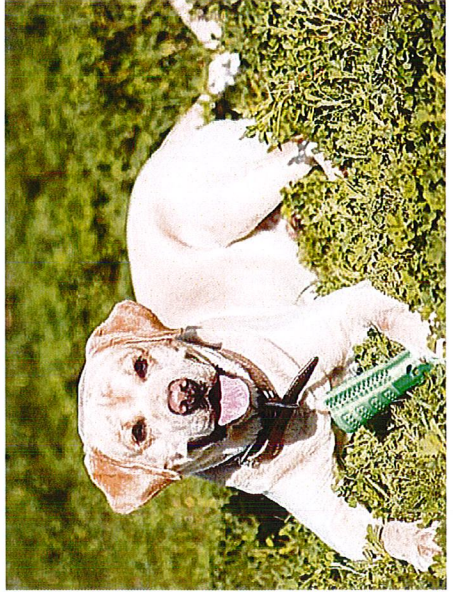
0000VA0002122450201

Deposit Materials

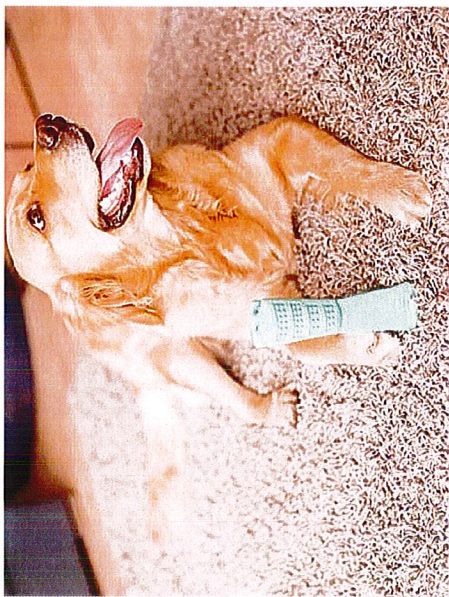
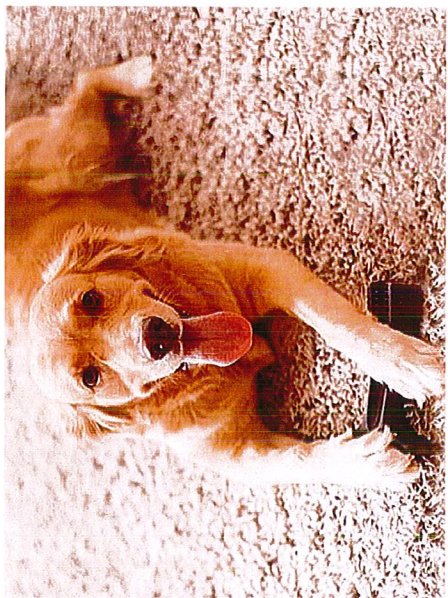
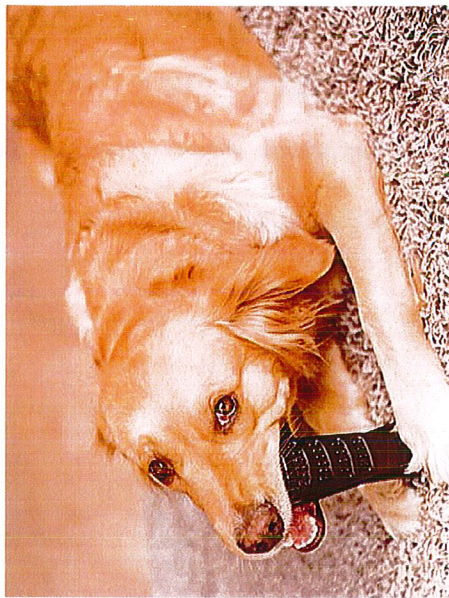


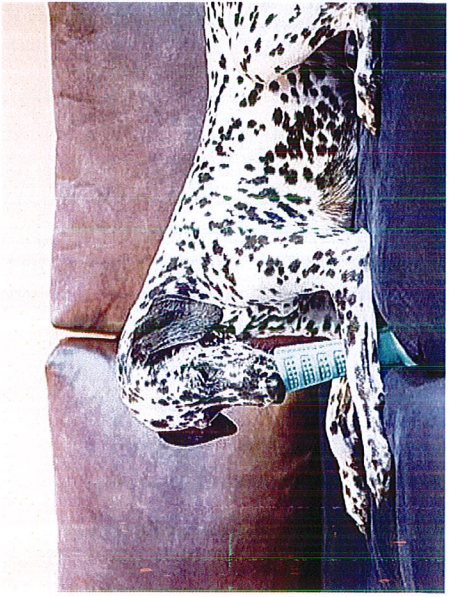
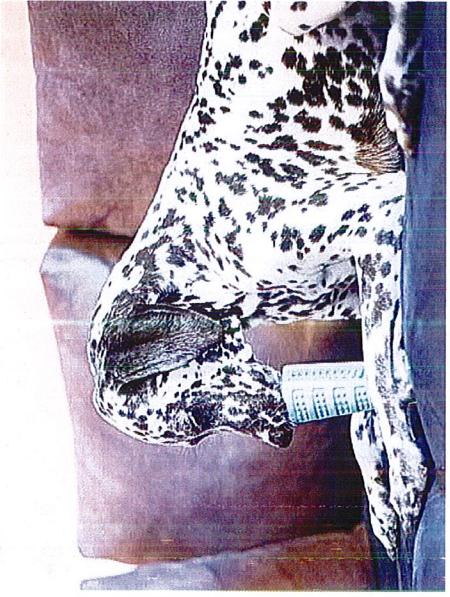
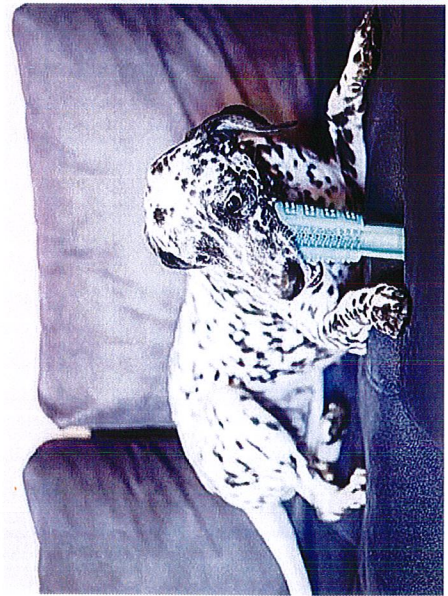
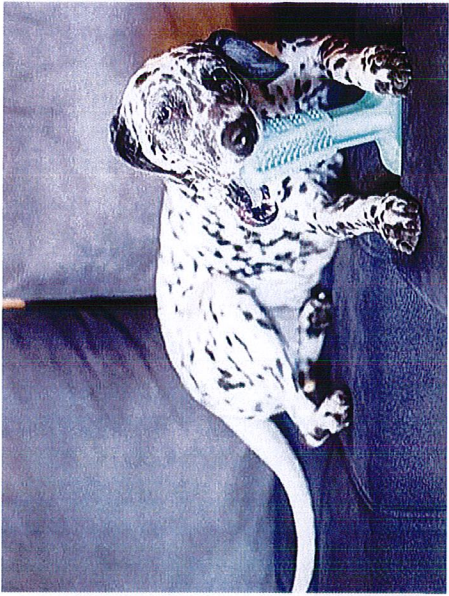
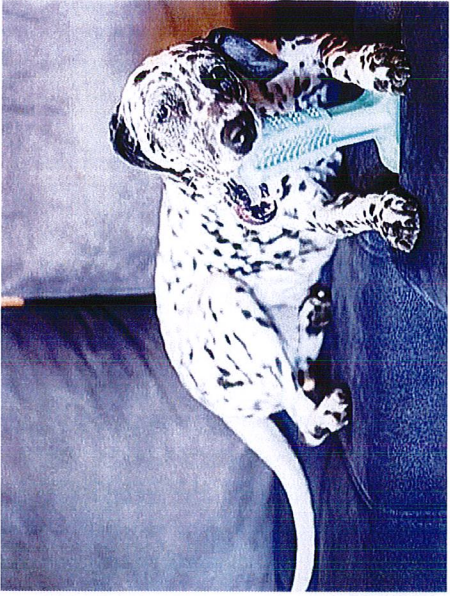
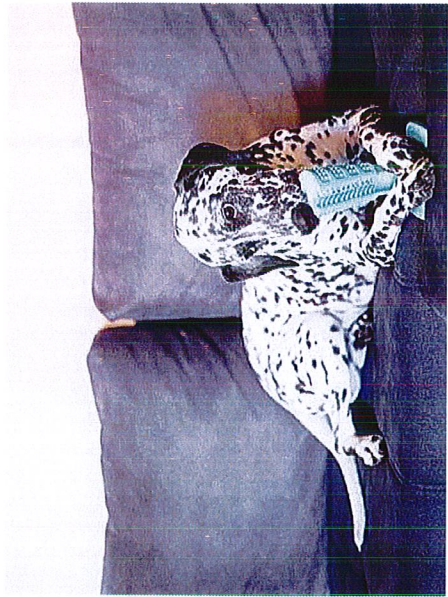
www.Bite

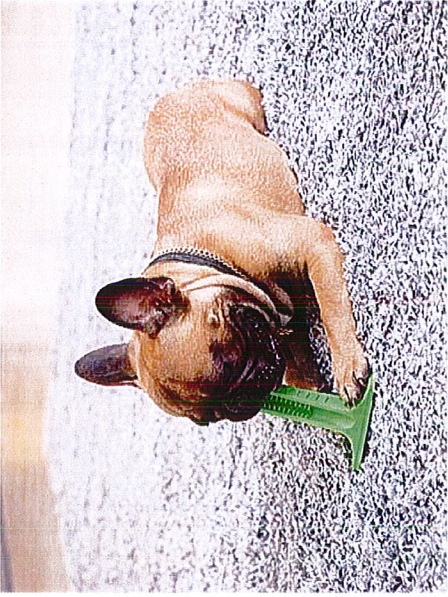












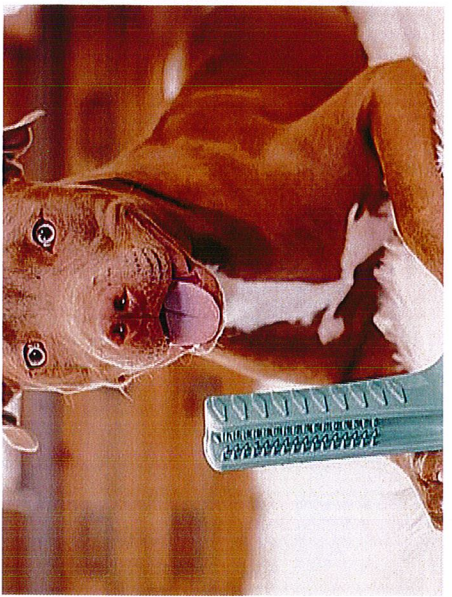
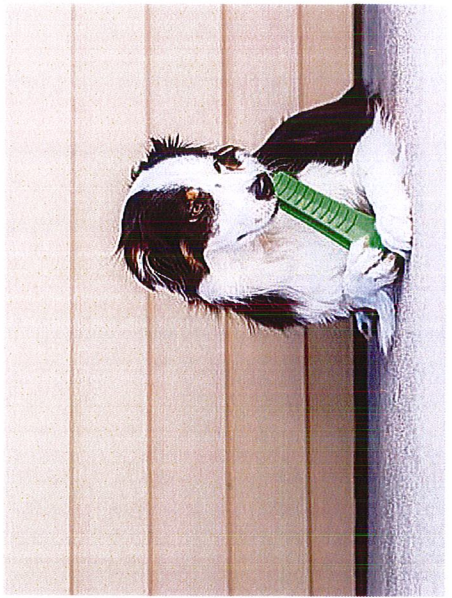
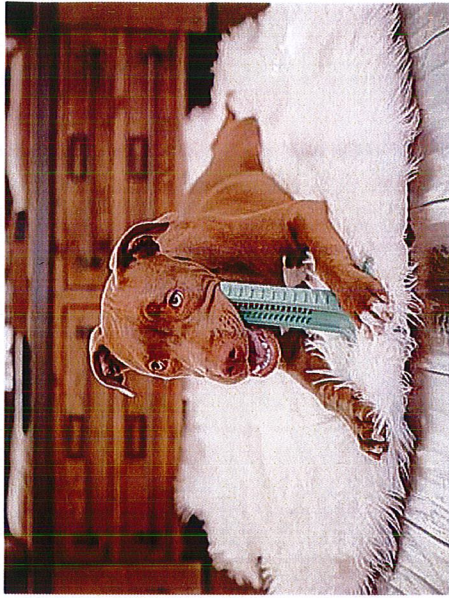




EXHIBIT 4

Registered / Eingetragen 07/11/2018

No 005818606-0001



EUROPEAN UNION INTELLECTUAL
PROPERTY OFFICE
CERTIFICATE OF REGISTRATION

This Certificate of Registration is hereby issued for the Registered Community Design identified below. The corresponding entries have been recorded in the Register of Community Designs.

AMT DER EUROPÄISCHEN UNION FÜR
GEISTIGES EIGENTUM
EINTRAGUNGSRKUNDE

Diese Eintragungsurkunde wird für das unten genannte eingetragene Gemeinschaftsgeschmacksmuster ausgestellt. Die entsprechenden Einträge sind in das Register für Gemeinschaftsgeschmacksmuster aufgenommen worden.

The Executive Director / Der
Exekutivdirektor

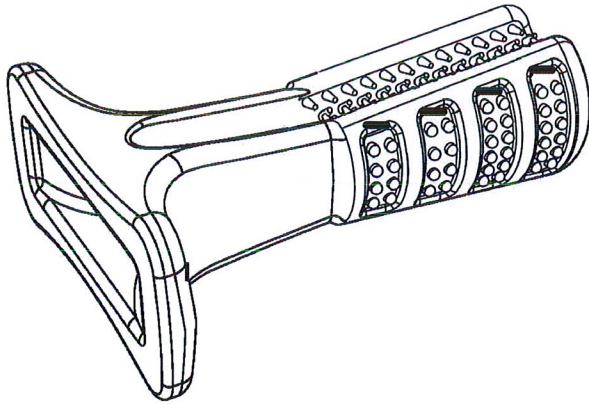
Christian Archambeau

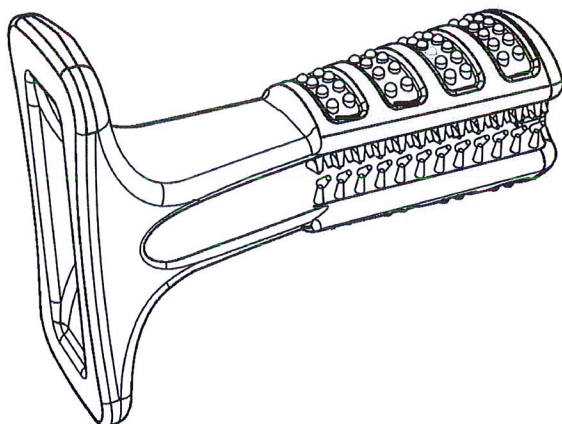


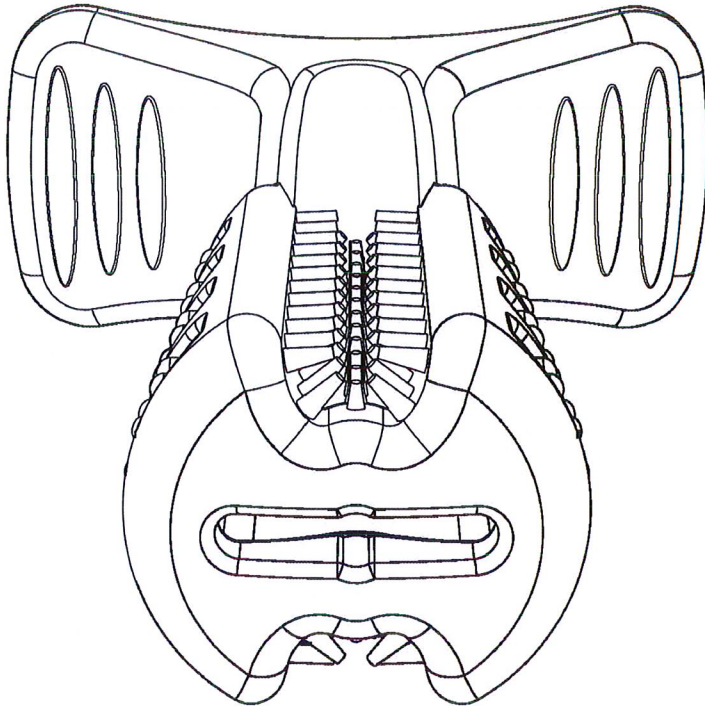
www.euiipo.europa.eu

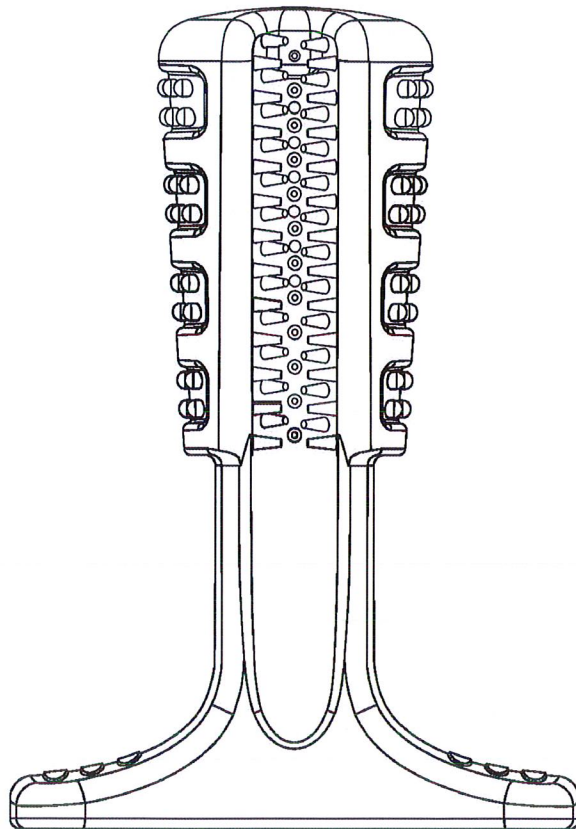


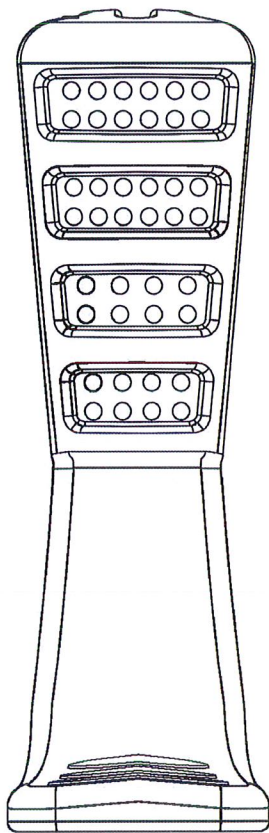
21 005818606-0001
25 EN - DE
22 07/11/2018
15 07/11/2018
45 15/01/2019
11 005818606-0001
73 Peter Dertsakyan
7700 Babcock Avenue
North Hollywood California 91605
ESTADOS UNIDOS (DE AMÉRICA)
74 SCHAUMBURG UND PARTNER PATENTANWÄLTE MBB
Mauerkircherstr. 31
D-81679 München
ALEMANIA
51 30 - 99
54 **BG** - Играчки за животни
ES - Juguetes para animales
CS - Hračky pro zvířata
DA - Legetøj til dyr
DE - Spielzeug für Tiere
ET - Loomamänguasjad
EL - Παιχνίδια για ζώα
EN - Toys for animals
FR - Jouets pour animaux
IT - Giocattoli per animali
LV - Dzīvnieku rotaļlietas
LT - Gvūnų žaislai
HR - Igračke za životinje
HU - Játékok állatoknak
MT - Ġugarelli għall-animali
NL - Speelgoed voor dieren
PL - Zabawki dla zwierząt
PT - Brinquedos para animais
RO - Jucării pentru animale
SK - Hračky pre zvieratá
SL - Igrače za živali
FI - Eläinten lelut
SV - Djurleksaker
30 US - 18/09/2018 - 29/663,715
57
55

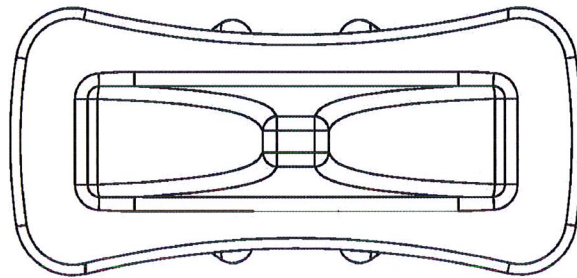












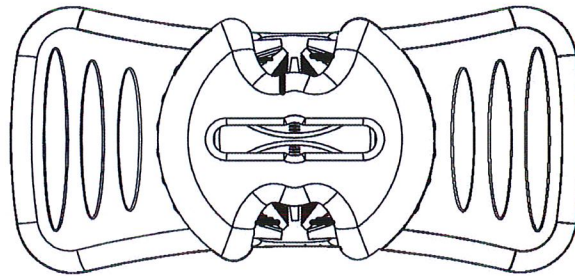


Exhibit 5



US010477838B2

(12) **United States Patent**
Dertsakyan

(10) **Patent No.:** **US 10,477,838 B2**
(45) **Date of Patent:** **Nov. 19, 2019**

(54) **PET CHEW TOY FOR DENTAL
SELF-CLEANING BY DOMESTIC PETS**

(71) Applicant: **Peter Dertsakyan**, North Hollywood,
CA (US)

(72) Inventor: **Peter Dertsakyan**, North Hollywood,
CA (US)

(*) Notice: Subject to any disclaimer, the term of this
patent is extended or adjusted under 35
U.S.C. 154(b) by 0 days.

(21) Appl. No.: **15/472,206**

(22) Filed: **Mar. 28, 2017**

(65) **Prior Publication Data**

US 2018/0295811 A1 Oct. 18, 2018

Related U.S. Application Data

(60) Provisional application No. 62/314,353, filed on Mar.
28, 2016.

(51) **Int. Cl.**
A01K 15/02 (2006.01)
A46B 9/02 (2006.01)
A46B 1/00 (2006.01)

(52) **U.S. Cl.**
CPC **A01K 15/026** (2013.01); **A46B 1/00**
(2013.01); **A46B 9/026** (2013.01); **A46B**
2200/1086 (2013.01)

(58) **Field of Classification Search**
USPC 119/702, 709–711; D30/160; 426/805,
426/144, 143, 104; 433/1; 424/442, 49
See application file for complete search history.

(56) **References Cited**

U.S. PATENT DOCUMENTS

1,408,520	A *	3/1922	Larsen	401/183
3,007,441	A *	11/1961	Eyer	A01K 13/002
					15/167.1
3,853,412	A *	12/1974	Griffin	A46B 11/0041
					15/104.061
5,072,481	A *	12/1991	Frank Weyer	A46B 5/0054
					15/167.2
D325,821	S *	5/1992	Schwartz	D4/106
5,360,026	A *	11/1994	Klinkhammer	A46B 5/002
					132/308
5,407,287	A *	4/1995	Braun	A46B 11/0017
					401/176
5,497,526	A *	3/1996	Klinkhammer	A46B 5/0012
					132/309
5,711,759	A *	1/1998	Smith	A61J 17/006
					601/139

(Continued)

OTHER PUBLICATIONS

Materials relating to Busy Buddy Bristle Bone, from www.chewy.com, obtained Sep. 25, 2018.

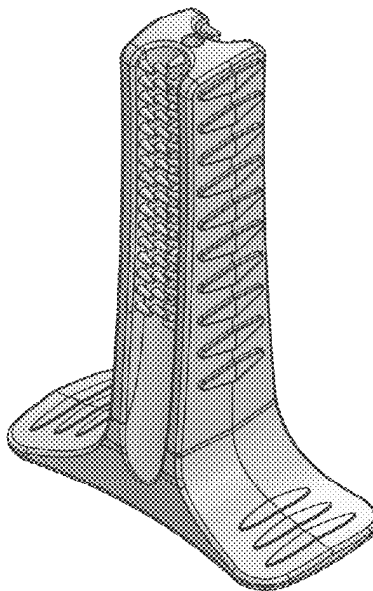
(Continued)

Primary Examiner — Andrea M Valenti
(74) *Attorney, Agent, or Firm* — David R. Preston

(57) **ABSTRACT**

A pet chew toy allowing for the self-cleaning of teeth by domestic pets. The pet toy includes one or more cavities into which a pet's teeth may engage, and the inner and outer surfaces of the cavities may have scrubbing elements designed to enhance removal of plaque and other unhygienic products from a pet's teeth and gums. The chew toy may further include projections to enhance stabilization of the chew toy by the pet, and a reservoir and dispensing system for pet toothpaste or similar additive.

17 Claims, 6 Drawing Sheets



(56)

References Cited

U.S. PATENT DOCUMENTS

5,842,249 A * 12/1998 Sato A46B 5/0008
15/167.2
5,944,516 A * 8/1999 Deshaies A61D 5/00
15/167.1
D417,319 S * 11/1999 Weiss, Jr. D30/119
6,116,191 A 9/2000 Suchowski
6,148,771 A * 11/2000 Costello A01K 15/026
119/709
D453,242 S * 1/2002 Kaplan A01K 15/026
D30/160
6,405,681 B1 * 6/2002 Ward A01K 15/026
119/707
6,739,287 B1 5/2004 Sarantis
D501,961 S 2/2005 Jager
D564,714 S * 3/2008 Axelrod D30/160
7,490,579 B2 2/2009 Axelrod
D635,309 S * 3/2011 Axelrod D30/160
8,166,600 B2 * 5/2012 Lee A46B 5/0062
15/167.1
8,807,088 B2 8/2014 Axelrod
8,935,992 B2 * 1/2015 Axelrod A01K 15/025
119/709
D771,326 S * 11/2016 Lai D30/160
9,744,014 B2 * 8/2017 Smith A61C 19/04
9,770,010 B2 * 9/2017 Wechsler A01K 15/026
2002/0083539 A1 * 7/2002 Bella A46B 5/0016
15/106
2004/0137118 A1 7/2004 Axelrod
2004/0216693 A1 11/2004 Handelsman
2005/0015908 A1 * 1/2005 Hanlon A46B 5/02
15/167.2
2006/0150919 A1 * 7/2006 Thomason A01K 15/026
119/710
2007/0015100 A1 * 1/2007 Morris A61D 5/00
433/1

2007/0101946 A1 * 5/2007 Penny A01K 13/00
119/709
2009/0208898 A1 * 8/2009 Kaplan A46B 9/045
433/80
2009/0276972 A1 * 11/2009 Dugan A46B 7/00
15/167.2
2011/0011351 A1 * 1/2011 Simoni A01K 15/026
119/709
2013/0266905 A1 * 10/2013 Smith A61C 19/04
433/1
2013/0305999 A1 * 11/2013 Axelrod A01K 15/026
119/710
2014/0060442 A1 * 3/2014 Ressemann A01K 13/00
119/61.5
2014/0123421 A1 * 5/2014 Minano Fernandez
A46B 9/045
15/110
2014/0224184 A1 * 8/2014 Dewey A01K 15/026
119/709
2018/0243063 A1 * 8/2018 Coopersmith A01K 15/026

OTHER PUBLICATIONS

Materials relating to Busy Buddy, from www.petsafe.net, obtained Sep. 25, 2018.
Materials relating to Busy Buddy Bristle Bone, from <https://ps.factoryoutletstore.com>, obtained Sep. 25, 2018.
Materials relating to Busy Buddy Bristle Bone, from <https://store/petsafe.net>, obtained Sep. 25, 2018.
Materials relating to Nylabone DuraChew Double Action Round Ball Bacon Flavor Dog Toy, from www.chewy.com, obtained Sep. 25, 2018.
Materials relating to Nylabone DuraChew Double Action Dental Chew Bacon Flavor Dog Toy, from www.chewy.com, obtained Sep. 25, 2018.

* cited by examiner

Figure 1

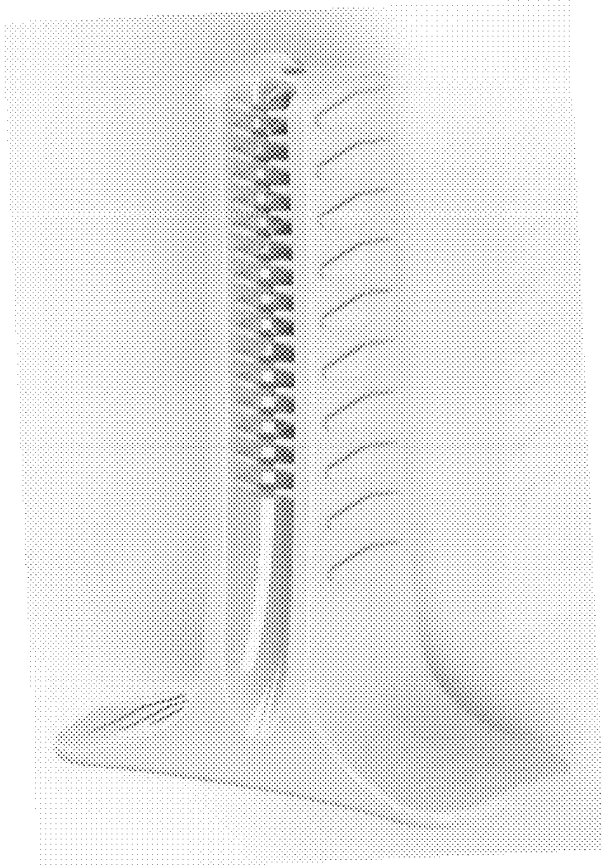


Figure 2

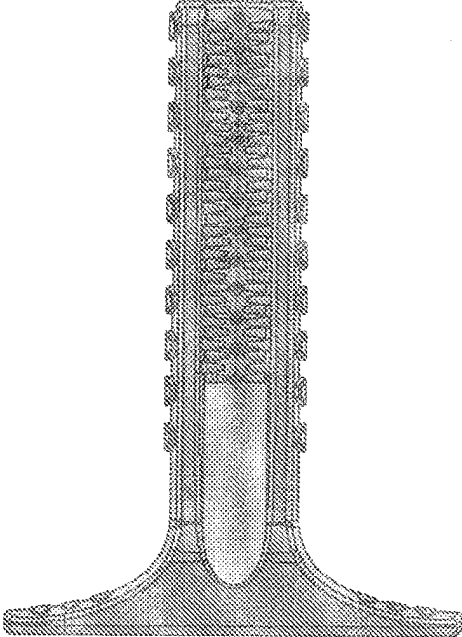


Figure 3

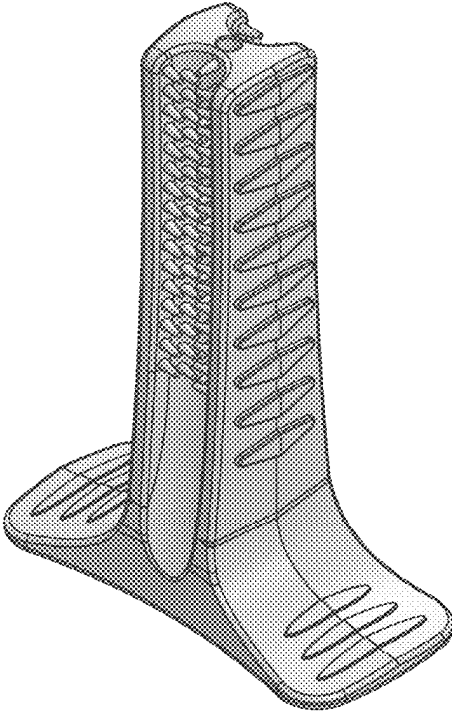


Figure 4

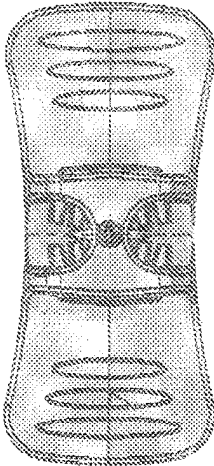
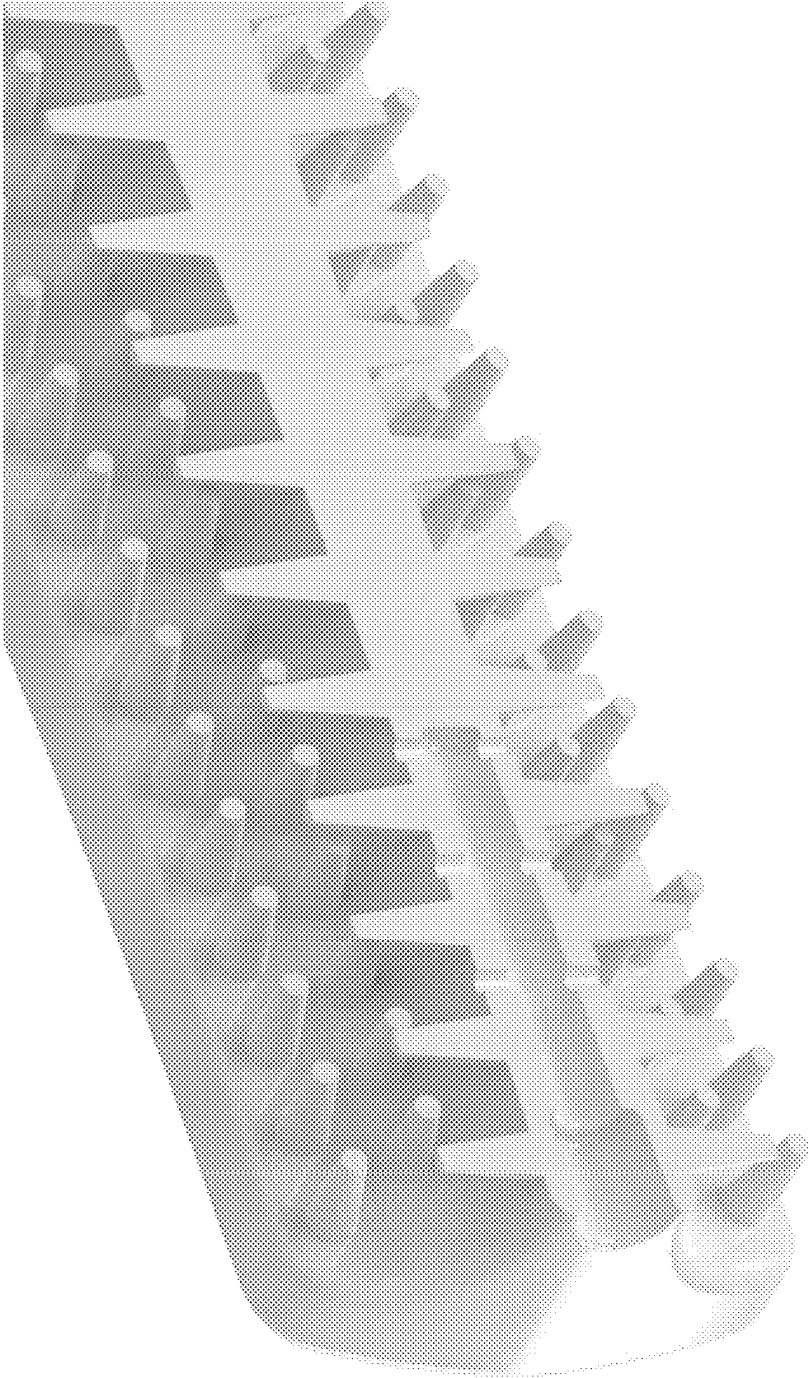


Figure 5



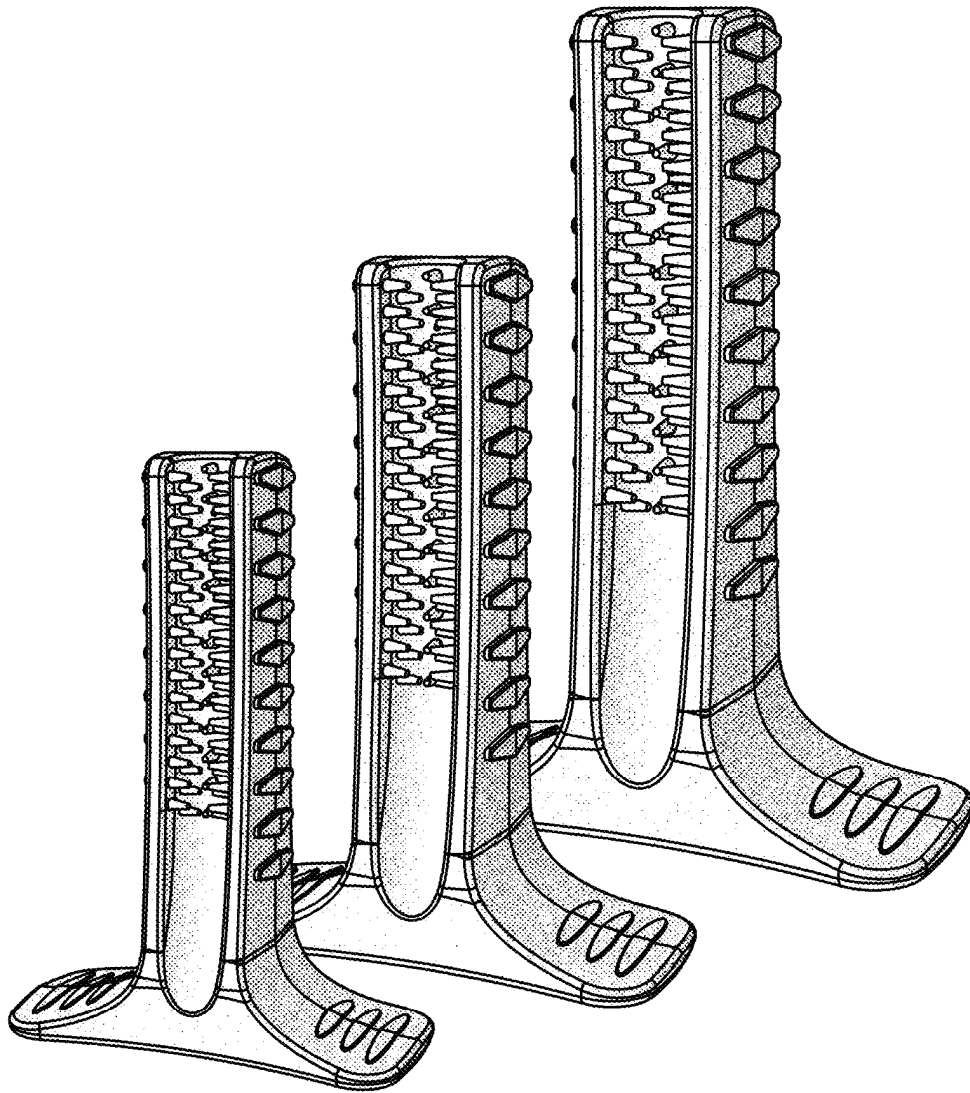


FIG. 6

1

**PET CHEW TOY FOR DENTAL
SELF-CLEANING BY DOMESTIC PETS**

CROSS-REFERENCE TO RELATED
APPLICATIONS

The present application claims priority to provisional application 62/314,353, filed Mar. 28, 2016, entitled "Toy for a Domestic Pet to Brush Its Own Teeth" which is incorporated by reference in its entirety herein.

STATEMENT REGARDING FEDERALLY
SPONSORED RESEARCH

Not applicable.

JOINT RESEARCH AGREEMENT STATEMENT

Not applicable.

FIELD OF THE INVENTION

The present invention relates to a pet chew toy and dental hygiene system, and particularly to pet chew toy allowing for the dental self-cleaning by domestic pets.

BACKGROUND

Maintaining the dental hygiene of domestic pets is a well-known issue. Like humans, domestic pets such as dogs and cats develop bacterial infections, known generally as plaque, on the surface and in the spaces between the teeth of said pets. In addition to the malodorous breath and appearance of domestic pets suffering from an excess of plaque, it can also precipitate the gum disease gingivitis, damage to the pet's teeth, and other material detriment to the oral health of the pet. If left routinely uncleaned, it can harden and become almost impossible to remove without professional assistance.

Traditional methods of cleaning the teeth of pets has involved labor-intensive manual cleaning by the pet owner, a process which is both time-consuming and often results in unnecessary antagonism between the domestic pet and its owner.

Wild relatives of domestic pets, such as wild dogs and wolves, use the frictional effects of gnawing on bones and other hard objects to clean their teeth of plaque and residual pieces of food. The use of domestic pet chew toys as a method of mimicking these natural dental hygiene methods for domestic pets is known in the art. As a consequence, many domestic animal chews or chew toys have been produced of rawhide or other hard surface and configured in such a way as to mimic the shape and feel of natural bone. Other products have introduced additional artificial features to improve upon the natural cleaning action of a domestic pet's chewing action on bone, such as the use of additional projections on a surface of the chew toy.

Information relevant to attempts to address these problems can be found in US Patent Application No. 2004/0216693 to Handelsman; U.S. Pat. No. 6,116,119 to Suchowski; U.S. Pat. No. 6,739,287 to Sarantis; U.S. Pat. D501,961 to Jager; US Patent Application no. 2004/0137118 to Axelrod; and U.S. Pat. Nos. 8,807,088 and 7,490,579 to Axelrod. However, each one of these references suffers from one or more disadvantages. One consistent failing of existing products relates to a domestic pet's propensity to grip or hold an object between its front paws. Domestic pets will

2

naturally seek to stabilize the subject of their chewing action, allowing for a stronger and more satisfying engagement by the pet's mouth, while increasing the friction applied to the pet's teeth and oral cavity by the bone or chew toy. Another failing of existing products is the inability to use pet toothpaste and other supplementary dental hygiene products in conjunction with the chewing action of the chew toys. This leaves the need for supplementary manual cleaning by the domestic pet owner. Yet another disadvantage of existing products is the lack of differentiated surfaces for inner and outer domestic pet teeth. Domestic pets, such as dogs and cats, have substantially different shape and spacing in their teeth between the front of their mouths, wherein are located canines and other long, large teeth, and the smaller, more closely spaced teeth in the back of the pets' mouths. The differences in size and spacing of these teeth suggest the need for different surfaces with different textures and projections adapted to the particular needs of that portion of the domestic pet's dental structures.

For the foregoing reasons, there is a need for an improved domestic pet chew toy that allows domestic pets to clean their own teeth.

SUMMARY

The present invention is directed to an apparatus that satisfies this need.

One possible embodiment of the invention takes the form of a chew toy for use by a domestic pet such as a dog, cat or other domesticated animal. This embodiment comprises a central member for engagement of a domestic pet's oral cavity, which includes at least one inner surface defining a cavity and an outer surface, each or both of which may have a variety of scrubbing elements affixed to them.

Another possible embodiment comprises a central member for engagement of a domestic pet's oral cavity, said member having a first end and a second end. The second end further comprises one or more projections, which may be circular or otherwise shaped, which are substantially flat and oriented perpendicular to the length of the central member. The projections allow the member to be stood upright and gripped by a domestic pet, using its front paws.

Yet another possible embodiment includes a reservoir running the length of the central member of a chew toy, in which, by way of non-limiting example, flavored toothpaste for domestic pets can be retained. Smaller dispensing holes are present in the central member perpendicular to the reservoir, allowing the toothpaste or other products to be dispensed into the oral cavity of a domestic pet when the central member is engaged by said pet's oral cavity.

BRIEF DESCRIPTION OF THE DRAWINGS

These and other features, aspects, and advantages of the present invention will become better understood with reference to the following description, appended claims, and drawings where:

FIG. 1 shows an embodiment of the invention having a central member with an inner surface defining a cavity, perpendicular stabilizing projections, and a plurality of scrubbing elements on the inner and outer surfaces of the central member.

FIG. 2 shows a side-view of an embodiment of the invention, showing the multiplicity of scrubbing elements projecting from the inner surfaces defining the cavity, and the outer surfaces of the member.

3

FIG. 3 shows an embodiment of the invention wherein the central member has inner surfaces defining two separate cavities.

FIG. 4 shows a top-down view of the embodiment of FIG. 3, with the positioning for an optional additional reservoir to retain pet toothpaste shown at center.

FIG. 5 shows a lengthwise cut-away of the central member of the embodiment of FIG. 3, demonstrating the shape and positioning of the additional reservoir, and smaller perpendicular holes for dispensing toothpaste retained in said reservoir.

FIG. 6 shows a comparison between different possible sizes of an embodiment of the invention.

DETAILED DESCRIPTION

In the Summary above and in the Detailed Description, and the claims below, and in the accompanying drawings, reference is made to particular features of the invention. It is to be understood that the disclosure of the invention in this specification includes all possible combinations of such particular features. For example, where a particular feature is disclosed in the context of a particular aspect or embodiment of the invention, or a particular claim, that feature can also be used, to the extent possible, in combination with and/or in the context of other particular aspects and embodiments of the invention, and in the invention generally.

The term “comprises” and grammatical equivalents thereof are used herein to mean that other components, ingredients, steps, etc. are optionally present. For example, an article “comprising” (or “which comprises”) components A, B, and C can consist of (i.e., contain only) components A, B, and C, or can contain not only components A, B, and C but also one or more other components.

The term “at least” followed by a number is used herein to denote the start of a range beginning with that number (which may be a range having an upper limit or no upper limit, depending on the variable being defined). For example, “at least 1” means 1 or more than 1. The term “at most” followed by a number is used herein to denote the end of a range ending with that number (which may be a range having 1 or 0 as its lower limit, or a range having no lower limit, depending upon the variable being defined). For example, “at most 4” means 4 or less than 4, and “at most 40%” means 40% or less than 40%. When, in this specification, a range is given as “(a first number) to (a second number)” or “(a first number)-(a second number),” this means a range whose lower limit is the first number and whose upper limit is the second number. For example, 25 to 100 mm means a range whose lower limit is 25 mm, and whose upper limit is 100 mm.

In one possible embodiment of the invention, as shown in FIG. 1, takes the form of a chew toy having a central member. The chew toy may be made of any suitable material, including by way of non-limiting example any non-toxic plastic. The central member comprises at least one inner surface, defining a cavity having an open end running the length of the central member and an additional open side at the top end of the central member. Said cavity should be of sufficient depth to allow full penetration by the front or back teeth of a domestic pet. The size of the central member, and therefore relative depth of the cavity, may be varied to suit a variety of domestic pet breeds, as shown in FIG. 6. By providing inner and outer surfaces for contact with the teeth and gums of a domestic pet, faster and more complete cleaning action is achieved on the pet’s teeth and gums by maximizing the area of contact and friction between the

4

central member and the pet’s teeth and gums. In addition, further cleaning action is achieved by the simultaneous contact of the surfaces of the member with the forward and inner teeth of the pet.

As shown in FIG. 2, the outer surface of the central body may have affixed to it a plurality of scrubbing elements. As also shown in FIG. 2, the inner surface defining the cavity may also have affixed to it an additional plurality of scrubbing elements.

The scrubbing elements affixed to the outer and inner surfaces may vary in size and shape. By way of example, they could take the form of bristles, pyramids, cones, rectangles, or any of a variety of other desirable configurations. The scrubbing elements affixed to the outer surface of the central member might, in one possible embodiment, be of a different shape or size than the scrubbing elements affixed to the inner surface, as shown in FIG. 2. Similarly, the size and shape of the scrubbing elements affixed to the inner surface might be the same as those affixed to the outer surface of the central member. This allows the scrubbing elements to be adapted to the differential spacing, tooth shape, and mouth size of a variety of domestic pets.

A further aspect of the present invention is shown in FIG. 1, comprising the substantially flat perpendicular projections. Although the embodiment shown in FIG. 1 has the projections take the form of two flanges or separate extensions, one of skill in the art will understand that the projection or projections can take a variety of shapes and sizes. Non-limiting examples might be a singular projection forming a circular base to the central member, or a multiplicity of flanges allowing a pet to grip the projections from a variety of angles. These projections allow a pet to fully stabilize the chew toy upright using their natural gripping action with the front paws.

In contrast to the rough or knobbed ends of natural bones or typical pet chew toys, here the domestic pet can fully pin down and stabilize the central member of the chew toy such that it is fully upright and immobile. This allows for a much stronger grip on the central body by the mouth of the domestic pet, increasing the friction between the surface of the chew toy and the pet’s teeth. This allows for superior cleaning and removal of plaque, leftover food, and other detrimental material from the mouth of the pet.

Yet a further aspect of the present invention is shown in FIG. 4, showing one possible embodiment of the central reservoir for toothpaste or other substances suitable for dispensing. Here, the opening allows for input of a pet toothpaste or other appropriate substance into the reservoir, which is dispensed through perpendicular holes to the main cavity or cavities of the chew toy. Although in this particular embodiment the reservoir takes a cylindrical form, other embodiments might include one or more reservoirs of different shapes or locations.

Another possible embodiment of the present invention is shown in FIG. 3. Here, the central member comprises two inner surfaces, each defining separate cavities similar to the single cavity shown in FIG. 1. By providing a second cavity, a domestic pet can simultaneously engage not just the forward and rear of the pet’s teeth and gums simultaneously, but on the top and bottom of the pet’s mouth as well.

What is claimed is:

1. A chew toy for pet dental hygiene, comprising:
 - a) a central chewing member,
 - comprising:
 - i) at least two U-shaped grooves that comprise, on at least a portion of all internal surfaces of said at

5

least two U-shaped grooves, a plurality of protruding scrubbing elements;

- a) wherein said at least two U-shaped grooves generally define said central chewing member with a first and second end;
 - b) further wherein said at least two U-shaped grooves are arranged parallel to each other and perpendicular, at said second end, to an at least one bottom stabilizing portion;
 - c) further wherein said at least two U-shaped grooves are each substantially the length of said central chewing member;
 - d) further wherein said at least two U-shaped grooves are positioned on opposing sides of said central chewing member;
 - e) further wherein each said at least two U-shaped grooves is generally U-shaped in cross section across said central chewing member;
 - ii) a plurality of nub shaped elements positioned on an outside surface of said central chewing member,
 - iii) at least one central aperture in said first end of said central chewing member and an at least one longitudinal cavity that begins at said aperture and runs at least a portion of the length of said central chewing member;
 - iv) at least one dispensing hole communicating between said at least one longitudinal cavity and said at least two U-shaped grooves, wherein said at least one dispensing hole is perpendicular to said at least one longitudinal cavity;
- b) said at least one bottom stabilizing portion, comprising:
- i) at least one substantially flat projection that stabilizes said chew toy when in use;
 - ii) wherein said at least one projection is perpendicular to said central chewing member;
 - iii) wherein said at least one bottom stabilizing portion is configured to stabilize said chew toy in an upright position; and
- wherein said chew toy is a unitary structure made of non-toxic material.
2. The chew toy of claim 1, wherein at least one of said at least two U-shaped grooves are sufficiently deep to clean teeth to the gum line.

6

3. The chew toy of claim 1, wherein said protruding scrubbing elements comprise bristles.

4. The chew toy of claim 1, wherein said at least one longitudinal cavity is configured to hold at least one substance.

5. The chew toy of claim 4, wherein said substance comprises toothpaste.

6. The chew toy of claim 1, wherein said at least one dispensing hole is adapted to transfer at least one substance between said at least one longitudinal cavity and said at least two U-shaped grooves.

7. The chew toy of claim 6, wherein said substance comprises toothpaste.

8. The chew toy of claim 1, wherein said pet comprises a dog.

9. The chew toy of claim 1, further wherein said chew toy is operable as a toothbrush for use by pets to brush their own teeth.

10. The chew toy of claim 1, wherein when chew toy is in use, multiple teeth and multiple surfaces of teeth are cleaned.

11. The chew toy of claim 1, wherein said chew toy comprises a single, unitary structure.

12. The chew toy of claim 1, wherein said chew toy comprises natural rubber.

13. A method of promoting pet dental hygiene, comprising:

- a) providing a pet in need of promotion of dental hygiene;
- b) providing a chew toy of claim 1;
- c) allowing said pet to engage with said chew toy; wherein the dental hygiene of said pet is promoted.

14. The method of claim 13, wherein said chew toy comprises toothpaste.

15. The method of claim 13, wherein said pet comprises a dog.

16. The method of claim 13, wherein at least one of said at least two grooves are sufficiently deep to clean teeth to the gum line.

17. The method of claim 13, wherein when chew toy is in use, multiple teeth and multiple surfaces of teeth are cleaned.

* * * * *

Exhibit 6

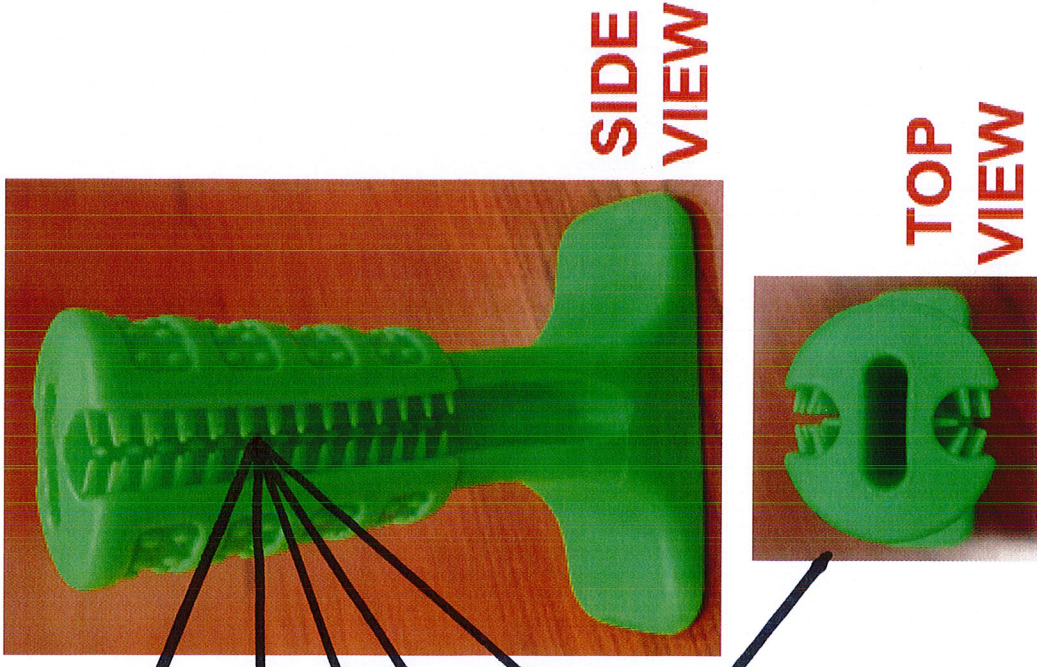
Text of Claim 1

A chew toy for pet dental hygiene, comprising:

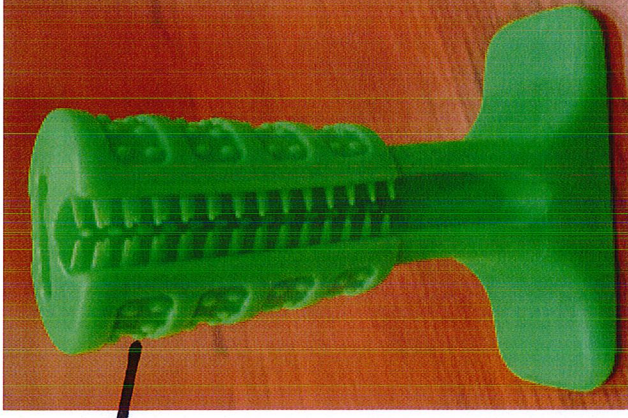
- a) a central chewing member, comprising:
 - i) at least two U-shaped grooves that comprise, on at least a portion of all internal surfaces of said at least two U-shaped grooves, a plurality of protruding scrubbing elements;
 - ii) wherein said at least two U-shaped grooves generally define said central chewing member with a first and second end;
 - iii) further wherein said at least two U-shaped grooves are arranged parallel to each other and perpendicular, at said second end, to an at least one bottom stabilizing portion;
 - iv) further wherein said at least two U-shaped grooves are each substantially the length of said central chewing member;
 - v) further wherein said at least two U-shaped grooves are positioned on opposing sides of said central chewing member;
 - vi) further wherein each said at least two U-shaped grooves is generally U-shaped in cross section across said central chewing member;

Type 1 Infringing Product

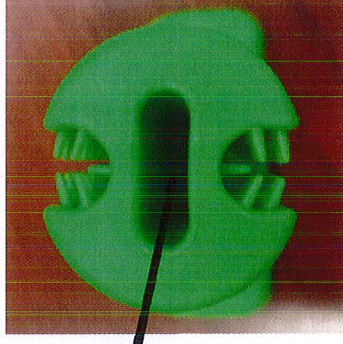
This is the preamble.



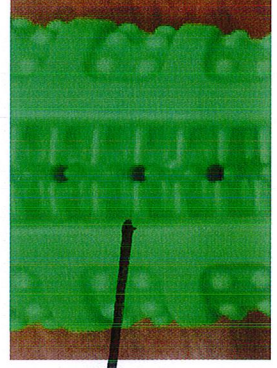
ii) a plurality of nub shaped elements positioned on an outside surface of said central chewing member,



iii) at least one central aperture in said first end of said central chewing member and an at least one longitudinal cavity that begins at said aperture and runs at least a portion of the length of said central chewing member;



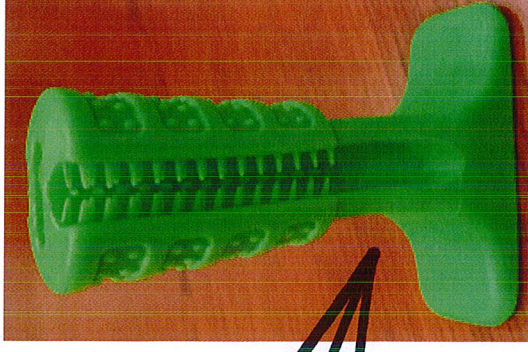
iv) at least one dispensing hole communicating between said at least one longitudinal cavity and said at least two U-shaped grooves, wherein said at least one dispensing hole is perpendicular to said at least one longitudinal cavity;



Type 1 Infringing Product against claim 1 of U.S Patent No. 10,477,838

b) said at least one bottom stabilizing portion, comprising:

- i) at least one substantially flat projection that stabilizes said chew toy when in use;
- ii) wherein said at least one projection is perpendicular to said central chewing member;
- iii) wherein said at least one bottom stabilizing portion is configured to stabilize said chew toy in an upright position; and



wherein said chew toy is a unitary structure made of non-toxic material.

Chew toy is a unitary structure made of non-toxic material.

Exhibit 7

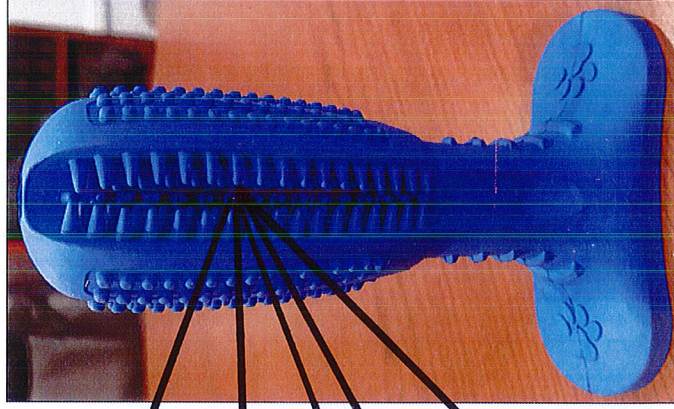
Text of Claim 1

A chew toy for pet dental hygiene, comprising:

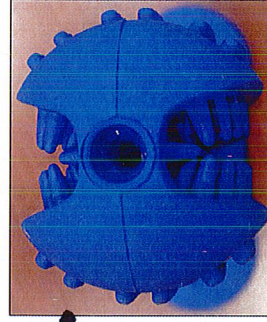
- a) a central chewing member, comprising:
 - i) at least two U-shaped grooves that comprise, on at least a portion of all internal surfaces of said at least two U-shaped grooves, a plurality of protruding scrubbing elements;
 - a) wherein said at least two U-shaped grooves generally define said central chewing member with a first and second end;
 - b) further wherein said at least two U-shaped grooves are arranged parallel to each other and perpendicular, at said second end, to an at least one bottom stabilizing portion;
 - c) further wherein said at least two U-shaped grooves are each substantially the length of said central chewing member;
 - d) further wherein said at least two U-shaped grooves are positioned on opposing sides of said central chewing member;
 - e) further wherein each said at least two U-shaped grooves is generally U-shaped in cross section across said central chewing member;

Type 2 Infringing Product

This is the preamble.

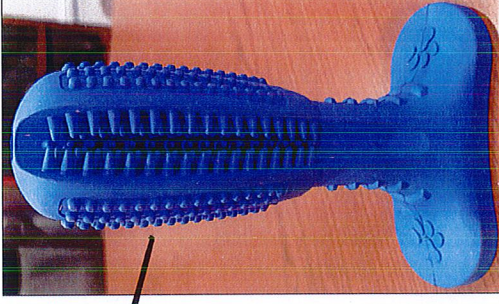


SIDE VIEW

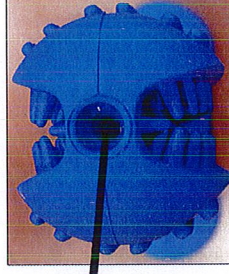


TOP VIEW

ii) a plurality of nub shaped elements positioned on an outside surface of said central chewing member,



iii) at least one central aperture in said first end of said central chewing member and an at least one longitudinal cavity that begins at said aperture and runs at least a portion of the length of said central chewing member;



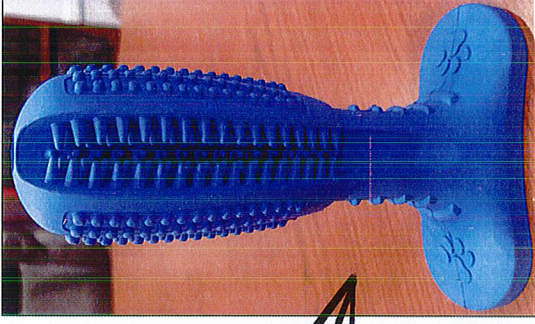
iv) at least one dispensing hole communicating between said at least one longitudinal cavity and said at least two U-shaped grooves, wherein said at least one dispensing hole is perpendicular to said at least one longitudinal cavity;



Type 2 Infringing Product against claim 1 of U.S Patent No. 10,477,838

b) said at least one bottom stabilizing portion, comprising:

- i) at least one substantially flat projection that stabilizes said chew toy when in use;
- ii) wherein said at least one projection is perpendicular to said central chewing member;
- iii) wherein said at least one bottom stabilizing portion is configured to stabilize said chew toy in an upright position; and



wherein said chew toy is a unitary structure made of non-toxic material.

Chew toy is a unitary structure made of non-toxic material.

EXHIBIT 8

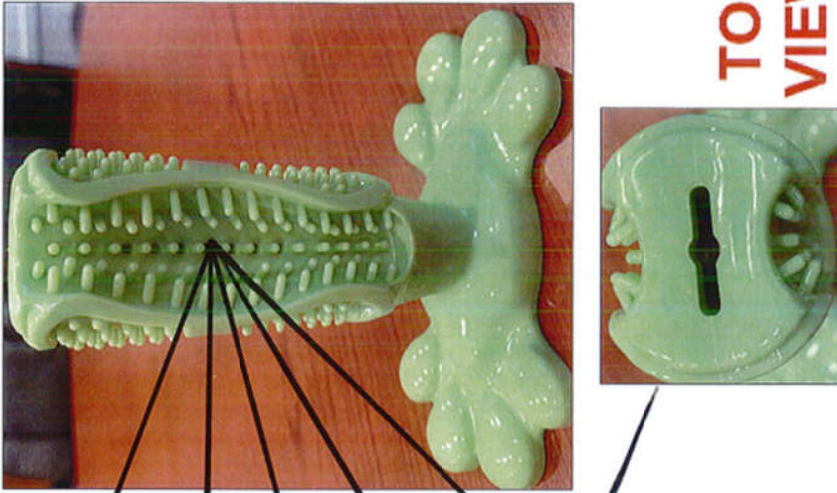
Text of Claim 1

A chew toy for pet dental hygiene, comprising:

- a) a central chewing member, comprising:
 - i) at least two U-shaped grooves that comprise, on at least a portion of all internal surfaces of said at least two U-shaped grooves, a plurality of protruding scrubbing elements;
 - a) wherein said at least two U-shaped grooves generally define said central chewing member with a first and second end;
 - b) further wherein said at least two U-shaped grooves are arranged parallel to each other and perpendicular, at said second end, to an at least one bottom stabilizing portion;
 - c) further wherein said at least two U-shaped grooves are each substantially the length of said central chewing member;
 - d) further wherein said at least two U-shaped grooves are positioned on opposing sides of said central chewing member;
 - e) further wherein each said at least two U-shaped grooves is generally U-shaped in cross section across said central chewing member;

Type 3 Infringing Product

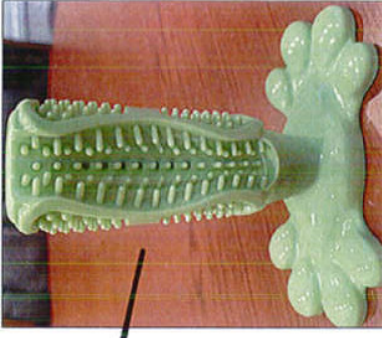
This is the preamble.



**SIDE
VIEW**

**TOP
VIEW**

ii) a plurality of nub shaped elements positioned on an outside surface of said central chewing member,



iii) at least one central aperture in said first end of said central chewing member and an at least one longitudinal cavity that begins at said aperture and runs at least a portion of the length of said central chewing member:

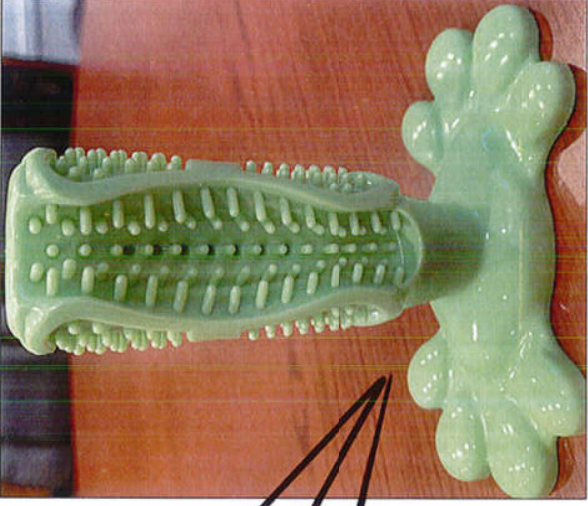


iv) at least one dispensing hole communicating between said at least one longitudinal cavity and said at least two U-shaped grooves, wherein said at least one dispensing hole is perpendicular to said at least one longitudinal cavity;



b) said at least one bottom stabilizing portion, comprising:

- i) at least one substantially flat projection that stabilizes said chew toy when in use;
- ii) wherein said at least one projection is perpendicular to said central chewing member;
- iii) wherein said at least one bottom stabilizing portion is configured to stabilize said chew toy in an upright position; and



wherein said chew toy is a unitary structure made of non-toxic material.

Chew toy is a unitary structure made of non-toxic material.

Exhibit 9

Text of Claim 1

A chew toy for pet dental hygiene, comprising:

a) a central chewing member, comprising:

i) at least two U-shaped grooves that comprise, on at least a portion of all internal surfaces of said at least two U-shaped grooves, a plurality of protruding scrubbing elements;

a) wherein said at least two U-shaped grooves generally define said central chewing member with a first and second end;

b) further wherein said at least two U-shaped grooves are arranged parallel to each other and perpendicular, at said second end, to an at least one bottom stabilizing portion;

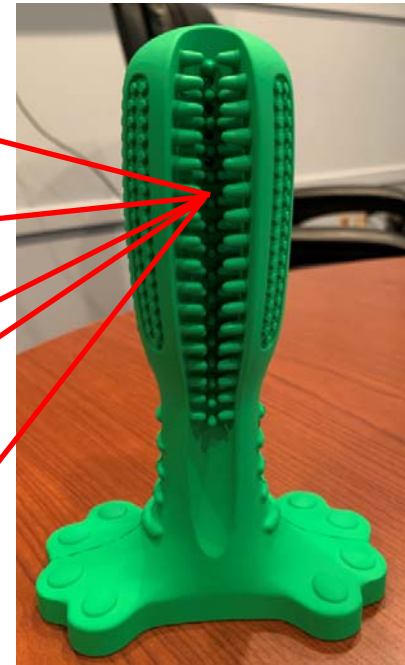
c) further wherein said at least two U-shaped grooves are each substantially the length of said central chewing member;

d) further wherein said at least two U-shaped grooves are positioned on opposing sides of said central chewing member;

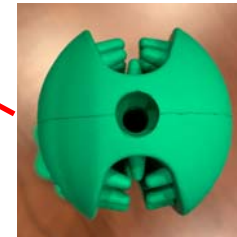
e) further wherein each said at least two U-shaped grooves is generally U-shaped in cross section across said central chewing member;

Type 4 Infringing Product

This is the preamble.



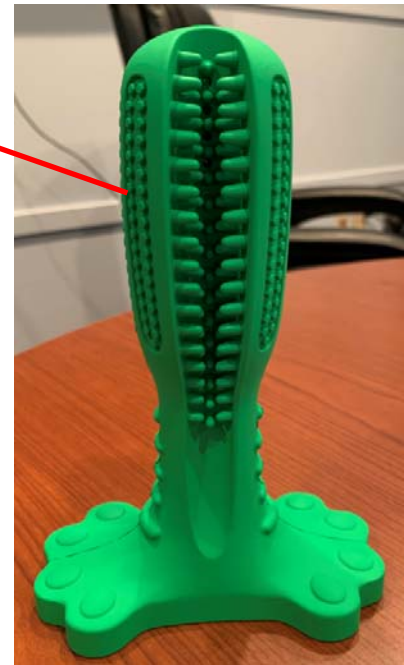
SIDE VIEW



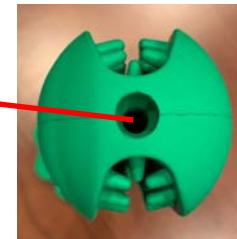
TOP VIEW

Type 6 Infringing Product against claim 1 of U.S Patent No. 10,477,838

ii) a plurality of nub shaped elements positioned on an outside surface of said central chewing member,



iii) at least one central aperture in said first end of said central chewing member and an at least one longitudinal cavity that begins at said aperture and runs at least a portion of the length of said central chewing member;



iv) at least one dispensing hole communicating between said at least one longitudinal cavity and said at least two U-shaped grooves, wherein said at least one dispensing hole is perpendicular to said at least one longitudinal cavity;



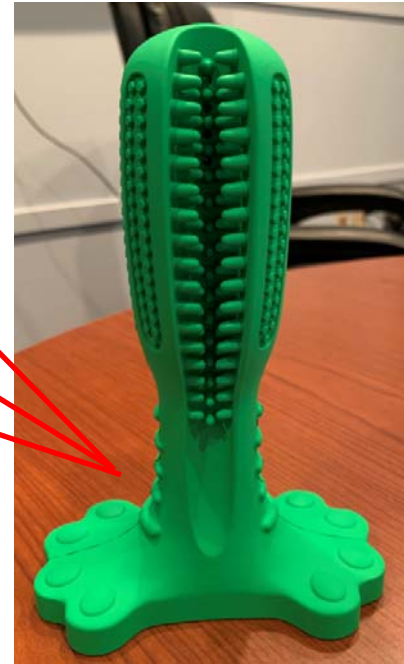
Type 6 Infringing Product against claim 1 of U.S Patent No. 10,477,838

b) said at least one bottom stabilizing portion, comprising:

i) at least one substantially flat projection that stabilizes said chew toy when in use;

ii) wherein said at least one projection is perpendicular to said central chewing member;

iii) wherein said at least one bottom stabilizing portion is configured to stabilize said chew toy in an upright position; and



wherein said chew toy is a unitary structure made of non-toxic material.

Chew toy is a unitary structure made of non-toxic material.