

IN THE UNITED STATES DISTRICT COURT
FOR THE WESTERN DISTRICT OF PENNSYLVANIA

JACKI EASLICK, LLC, and JE CORPORATE LLC,

Plaintiffs,

v.

CJ EMERALD, ABEL TANG, ACCENCYC US, ATRISS,
AUTROW, BESTOYARD, BOKWIN, BONNIE CHILD,
CBTONE, COCO'S HOUSE, COLORED FLAG,
DSVENROLY DIRECT, ENTERTAINMENT FIRST,
FACING THE OCEAN, FEPERIG, FITNICE OFFICIAL,
FULL OF STARS.MIN, GARDEISH, GUTAPO,
HEMPHILL HEN, HERLLOY, HOME DEPUTY,
IDUSHOME, JAGOGH YSON, JINGWEI-US,
JONERCEY, JRUIA, KARIN YANG, KEYBOO INC,
LASENERSM, LIMICOUNTS, LIPU HOOKER,
LITEVISO, LMPOSING, LUKINM, M.METEORITE,
MAYBELLER, MUYUSH, MYFOLRENA OFFICIAL,
MZEKGXM, NEZA-US, NISHUNA, PATRICK YAO,
PBFZ, PENGWH SHOP, QIKITA, ROBITENO,
SHANNON WENHA, SI PEIHONG, SINUOXIANG,
SOMIROW, SURMOUNTY, THINKCREATORS,
THOMAS ZACK YANG, TRACY ZHONG, TRAVELNA,
UFURMATE US, UME SPORTS, VITONG, WAITKEY
DIRECT, WEKIWGOT-US, YANHUSLSNE, ZARA LEI,
ZEDODIER, ZGCZZ, ZHANGHETING, and ZHONG
ROY,

Defendants.

Civil Action No.

FILED UNDER SEAL

**DECLARATION OF NICHOLAS MESITI, ESQ., IN SUPPORT OF PLAINTIFFS'
MOTION FOR A PRELIMINARY INJUNCTION**

I, Nicholas Mesiti, Esq., under penalty of perjury, declare and state as follows:

I. INTRODUCTION

1. I am an attorney duly admitted to practice law in the State of New York and have been retained as an expert by JE Corporate, LLC and Jacki Easlick, LLC (hereinafter "Plaintiffs") in connection with the above-captioned action. I make this declaration in support of Plaintiffs' motion for a preliminary injunction.

2. My Curriculum Vitae is attached as an exhibit (see **Exhibit A**). My time in this matter is billed at a rate of \$580 per hour.

3. As set forth in the Complaint in this matter, JE Corporate, LLC is the owner of United States Patent No. D695,526, entitled "HANDBAG HANGER HOOK" (hereinafter "the `526 patent") (see **Exhibit B**). Plaintiffs have accused CJ Emerald, Abel Tang, AccEncyc US, Atriss, Autrow, Bestoyard, BokWin, Bonnie Child, CBTONE, Coco's House, Colored Flag, DSVENROLY Direct, Entertainment First, Facing the Ocean, Feperig, FitNice Official, Full of Stars.min, Gardeish, Gutapo, Hemphill Hen, Herlloy, Home Deputy, IdusHome, Jagogh Yson, JingWei-US, Jonercey, JRUIA, Karin Yang, Keyboo Inc., Lasenersm, Limicounts, LIPU Hooker, LiteViso, Lmposing, Lukinm, M.Meteorite, Maybeller, Mutush, Myfolrena Official, Mzekgxm, Neza-US, Nishuna, Patrick Yao, PBFZ, PengWH Shop, Qikita, Robiteno, Shannon Wenha, Si Peihong, Sinuoxiang, Somirow, Surmounty, ThinkCreators, Thomas Zack Yang, Tracy Zhong, Travelna, Ufurmate US, UME Sports, Vitong, Waitkey Direct, Wekiwgot-US, Yanhuslsne, Zara Lei, Zedodier, ZGCZZ, Zhangheting, and Zhong Roy, (hereinafter "Defendants") of infringing the `526 patent with the following products:

Infringing Product Type 1.

Infringing Product Type 2.

Infringing Product Type 3.

Infringing Product Type 4.

4. I have been retained to provide an opinion on Defendants' infringement of the `526 patent, and the `526 patent's validity. In forming the opinions expressed herein, I relied on my extensive experience as a patent attorney, which includes experience prosecuting and litigating utility and design patents and the factual considerations and legal analyses brought to bear in determining infringement and validity thereof.

II. BACKGROUND, EDUCATION, AND QUALIFICATIONS

5. I have been a practicing attorney since 1988, and am currently a member and shareholder in the intellectual property law firm of Heslin, Rothenberg, Farley, & Mesiti, P.C., located at 5 Columbia Cir., Albany, NY, where I have practiced law since 1990. My

practice focuses exclusively on intellectual property law including patent, trademark, copyright, and unfair competition law with emphasis on utility patent, design patent, trademark, and copyright litigation before federal trial and appellate courts of the United States. I have represented numerous clients at trial and on appeal for the purposes of seeking preliminary injunctions, permanent injunctions, accountings and damages. I have counseled clients in various intellectual property matters, including infringement of design patents.

6. I received a Bachelor of Science degree in Mechanical Engineering in 1985 from Rensselaer Polytechnic Institute in Troy, New York. I received my Juris Doctorate degree in 1988 from Albany Law School of Union University, Albany, New York.
7. I personally have prosecuted and/or litigated over a hundred design patents with the United States Patent and Trademark Office and United States federal courts, and my firm has likewise prosecuted and/or litigated over 3000 design patents.

III. OVERVIEW OF MY EXPERT OPINIONS

8. My expert opinions are based on my knowledge, background, experience, and my review of the materials listed below:

The complaint in this matter;

United States Patent No. D695,526, and the prosecution history thereof and the references and prior art cited therein (see **Exhibit B**);

United States Patent No. D560,924 (see **Exhibit C**);

United States Patent No. 5,575,446 (see **Exhibit D**);

United States Patent No. D475,278 (see **Exhibit E**);

United States Patent No. D493,092 (see **Exhibit F**);

United States Patent No. D644,438 (see **Exhibit G**);

One of Infringing Product Type 1 (see **Exhibit H**);

One of Infringing Product Type 2 (see **Exhibit I**);

One of Infringing Product Type 3 (see **Exhibit J**);

One of Infringing Product Type 4 (see **Exhibit K**);

Plaintiff's webpage featuring the design (see **Exhibit L**);

Webpages featuring Infringing Product Type 1 (see **Exhibit M**);

Webpages featuring Infringing Product Type 2 (see **Exhibit N**);

Webpages featuring Infringing Product Type 3 (see **Exhibit O**); and

Webpages featuring Infringing Product Type 4 (see **Exhibit P**).

9. It is my expert opinion that the accused products infringe the `526 patent, and that the `526 patent is valid over the references and prior art cited in the `526 patent and by the United States Patent and Trademark Office during prosecution.

10. In formulating my opinions, I have drawn from my understanding of United States law pertaining to interpreting the claims of design patents, determining whether articles infringe such claims, and whether such claims are valid. Among the many pertinent federal court decisions which I am familiar with and which I have based my analyses on, the following cases are included: *Microsoft Corp. v. i4i Ltd. P'ship*, 131 S. Ct. 2238, 180 L. Ed. 2d 131 (2011); *Graham v. John Deere Co. of Kansas City*, 383 U.S. 1, 86 S. Ct. 684 (1966); *Gorham Mfg. Co. v. White*, 81 U.S. 511, 20 L. Ed. 731 (1871); *Crocs, Inc. v. Int'l Trade Comm'n*, 598 F.3d 1294 (Fed. Cir. 2010); *Int'l Seaway Trading Corp. v. Walgreens Corp.*, 589 F.3d 1233 (Fed. Cir. 2009); *Egyptian Goddess, Inc. v. Swisa, Inc.*, 543 F.3d 665 (Fed. Cir. 2008) (*en banc*); *Catalina Lighting, Inc. v. Lamps Plus, Inc.*, 295 F.3d 1277 (Fed. Cir. 2002); *Hupp v. Siroflex of Am., Inc.*, 122 F.3d 1456 (Fed. Cir. 1997); *OddzOn Products, Inc. v. Just Toys, Inc.*, 122 F.3d 1396 (Fed. Cir. 1997); *L.A. Gear, Inc. v. Thom McAn Shoe Co.*, 988 F.2d 1117 (Fed. Cir. 1993); and *In re Sung Nam Cho*, 813 F.2d 378 (Fed. Cir. 1987); *Ethicon Endo-Surgery, Inc. v. Covidien, Inc.* 796 F.3d 1312 (Fed. Cir. 2015).

IV. LEGAL STANDARDS APPLIED IN AN INFRINGEMENT ANALYSIS

11. I understand that the first step in conducting an analysis of infringement of a design patent entails construing the patent's claim ("claim construction"), which is an issue of law, followed by a factual inquiry as to whether there has been infringement. *Egyptian Goddess, Inc. v. Swisa, Inc.*, 543 F.3d at 679-80.

Construction of Design Patent Claims

12. I understand that a design patent covers the nonfunctional, ornamental features of a design.

13. Design patents claim an overall design, and a claim construction that results from excessive focus on individual features of a design at the expense of considering the overall design is incorrect. *Crocs, Inc. v. Int'l Trade Comm'n*, 598 F.3d at 1303. Because design patents typically claim designs as shown in drawings, the primary basis for construing the overall design claimed in such patents is by observation of the drawings. *Crocs, Inc. v. Int'l Trade Comm'n*, 598 F.3d at 1302; *Egyptian Goddess, Inc. v. Swisa, Inc.*, 543 F.3d at 679. Because claim construction consisting of detailed verbal descriptions is likely to define a claim scope that is not an accurate representation of the overall visual impression manifested by the claimed drawings themselves, such verbally detailed construction of design patent claims is disfavored. *Crocs, Inc. v. Int'l Trade Comm'n*, 598 F.3d 1302; *Egyptian Goddess, Inc. v. Swisa, Inc.*, 543 F.3d at 679.
14. Additional factors, such as conventions applied in drafting design patents and their drawings and assertions made during patent prosecution, may also be brought to bear to determine the scope of patent protection embodied in the drawings claimed in a design patent. *Egyptian Goddess, Inc. v. Swisa, Inc.*, 543 F.3d at 680.

Infringement of Design Patent Claims

15. I further understand that determining infringement of a design patent's claim is a factual determination and that it requires application of what is termed the "ordinary observer" test. *Gorham Mfg. Co. v. White*, 81 U.S. at 528; *Egyptian Goddess, Inc. v. Swisa, Inc.*, 543 F.3d at 670.
16. Infringement is found according to the ordinary observer test when, "in the eye of an ordinary observer, giving such attention as a purchaser usually gives, two designs are substantially the same, [and] the resemblance is such as to deceive such an observer, inducing him to purchase one supposing it to be the other." *Egyptian Goddess, Inc. v. Swisa, Inc.*, 543 F.3d at 670, quoting *Gorham Mfg. Co. v. White*, 81 U.S. at 528. While a side-by-side comparison of the claimed design and the infringing design may be helpful in evaluating infringement, the test itself focuses on how the designs would

be interpreted by an ordinary observer familiar with the prior art, and not merely on whether the designs have shared features. *Croc, Inc. v. Int'l Trade Comm'n*, 598 F.3d at 1307.

17. Infringement is found where an article embodies the overall effect of a claimed design. *Crocs, Inc. v. Int'l Trade Comm'n*, 598 F.3d at 1306. Because infringement requires only similarity of an article's design to a claimed design and not absolute identity between the two, infringement is found where an article's design is similar enough to a claimed design to exhibit the overall impression of the ornamental design features as claimed, and a finding of infringement does not require that the design of the article be identical to the claimed design. *Egyptian Goddess, Inc. v. Swisa, Inc.*, 543 F.3d at 678.
18. In addition to comparing a patented design to an allegedly-infringing article in applying the ordinary observer test, comparison with prior designs that are similar to the patented design may also be of assistance, because the ordinary observer is presumed to have a general understanding of such prior designs as well. *Crocs, Inc. v. Int'l Trade Comm'n*, 598 F.3d at 1303; *Egyptian Goddess, Inc. v. Swisa, Inc.*, 543 F.3d at 678-79.
19. The ordinary observer test is applied by considering what impression an ordinary purchaser would form when purchasing an accused article, rather than the impression an expert in the field would form under those circumstances. *Egyptian Goddess, Inc. v. Swisa, Inc.*, 543 F.3d at 670.

IV. LEGAL STANDARDS APPLIED IN A VALIDITY ANALYSIS

20. To be valid, the invention claimed in a design patent must be novel and nonobvious. Tests for novelty and nonobviousness are applied to the claims of a design patent in the same manner as they are to those of a utility patent. *Hupp v. Siroflex of Am., Inc.*, 122 F.3d at 1462. Furthermore, just as for utility patents, a design patent is presumed valid, and this presumption can be overcome only by clear and convincing evidence. *Microsoft Corp. v. i4i Ltd. P'ship*, 131 S. Ct. at 2243; *Catalina Lighting, Inc. v. Lamps Plus, Inc.*, 295 F.3d at 1288.

Functionality

21. The presence of functional features in a design does not render a claim to such a design invalid. Rather, the scope of protection afforded by such a claim is limited to the ornamental, nonfunctional aspects of the claimed design. *OddzOn Products, Inc. v. Just Toys, Inc.*, 122 F.3d at 1406. Thus, when the claimed design is compared to the accused design, functional features are to be ignored. *Catalina Lighting, Inc. v. Lamps Plus, Inc.*, 295 F.3d at 1287. Furthermore, “[i]n determining whether a claimed design is primarily functional, ‘[t]he function of the article itself must not be confused with ‘functionality’ of the design of the article.’” *Ethicon Endo-Surgery, Inc. v. Covidien*, 796 F.3d at 1328 (quoting *Hupp v. Siroflex of Am., Inc.* 122 F.3d at 1462). A design is functional and thus invalid if the design is essential to the use and purpose of the article. *Ethicon Endo-Surgery, Inc. v. Covidien*, 796 F.3d at 1328; *L.A. Gear, Inc. v. Thom McAn Shoe Co.*, 988 F.2d at 1123. And, a design is essential to the use or purpose of the article if the design is “dictated by” its use or purpose (i.e., function). *Ethicon Endo-Surgery, Inc. v. Covidien*, 796 F.3d at 1328 (citing *In re Carletti*, 328 F.2d 1020, 1022 (1964)); see also *L.A. Gear, Inc. v. Thom McAn Shoe Co.*, 988 F.2d at 1123. When there are numerous different designs that are capable of performing the same function as a claimed design, differences between such designs and the claimed design are not dictated by functional concerns and may be considered ornamental. *L.A. Gear, Inc. v. Thom McAn Shoe Co.*, 988 F.2d at 1123. The availability of such alternative designs is an important, if not dispositive, factor in evaluating the legal functionality of a claimed design. *Ethicon Endo-Surgery, Inc. v. Covidien*, 796 F.3d at 1329-30. As a result, “an inquiry into whether a claimed design is primarily functional should begin with an inquiry into the existence of alternative designs.” *Id.* at 1330. “To be considered an alternative, the alternative design must simply provide ‘the same or similar functional capabilities.’” *Id.* at 1331 (quoting *Rosco, Inc. v. Mirror Lite Co.*, 304 F.3d 1373, 1378 (Fed. Cir. 2002))

Novelty

22. The claim to a design is not invalid for anticipation (i.e., lack of novelty) unless a prior art reference by itself teaches a design that is substantially the same as the claimed design. In this regard, the "ordinary observer" test that is applied to determine whether an article infringes the claim in a design patent is also applied to determine whether a prior art reference renders the claim in a design patent invalid for anticipation. That is, a

design patent is novel when its overall appearance is not so substantially similar to a design embodied in a single prior art reference that an ordinary observer would be deceived into mistaking the claimed design for that embodied in the prior art reference. *Int'l Seaway Trading Corp. v. Walgreens Corp.*, 589 F.3d at 1239-40.

Nonobviousness

23. The claim to a design is not invalid for obviousness unless, at the time the claimed design was invented, the overall appearance of the claimed design would have been obvious to someone who has ordinary skill in designing the articles involved, in light of prior art that collectively contains all of the ornamental features of the claimed design. Four factors must be considered in determining whether a claim to a design is obvious: (1) the scope and content of the prior art; (2) differences between the claim and the prior art; (3) the level of ordinary skill in the prior art; and (4) secondary considerations, if any, of nonobviousness. *Graham v. John Deere Co. of Kansas City*, 383 U.S. at 17-18, 86 S. Ct. at 694; *Hupp v. Siroflex of Am., Inc.*, 122 F.3d at 1462; *L.A. Gear, Inc. v. Thom McAn Shoe Co.*, 988 F.2d at 1124.
24. A claim to a design is not invalid for obviousness merely because each of several prior art references contain the features of the claimed design. Rather, invalidity for obviousness requires that there was some reason, for ornamentality purposes, to combine the teachings of the prior art to create a design with the same overall visual appearance as the claimed design. *In re Sung Nam Cho*, 813 F.2d at 382.

V. ANALYSES

Claim Construction

25. The `526 patent claims "[t]he ornamental design for a handbag hanger hook, as shown and described." One embodiment is depicted therein in eight drawings. The eight drawings corresponding to the depicted embodiment are shown below, and are described in the `526 patent as follows:

Fig. 1 is a perspective view of the handbag hanger hook;

Fig. 2 is a front elevational view thereof;

Fig. 3 is a rear elevational view thereof;

Fig. 4 is a right-side elevational view thereof;

Fig. 5 is a left-side elevational view thereof;

Fig. 6 is a bottom plan view thereof;

Fig. 7 is a top plan view thereof; and,

Fig. 8 is a reduced scale perspective view thereof wherein the top hook is hung on a rod, with a handbag hanging from the bottom hook. The broken line showing the rod and handbag in Fig. 8 is included for the purpose of showing environmental structure and forms no part of the claimed design.

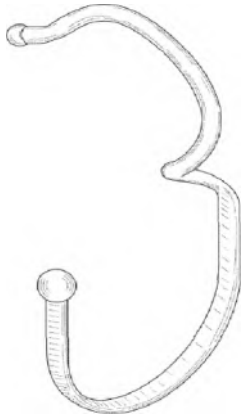

FIG. 1

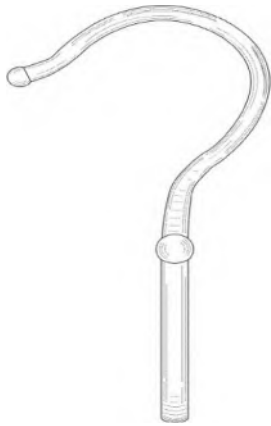

FIG. 2

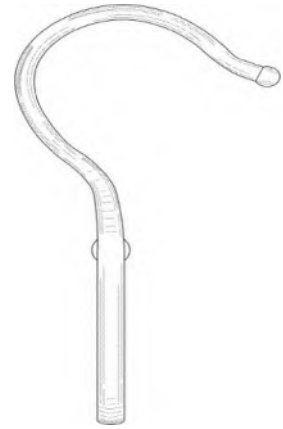

FIG. 3



FIG. 4

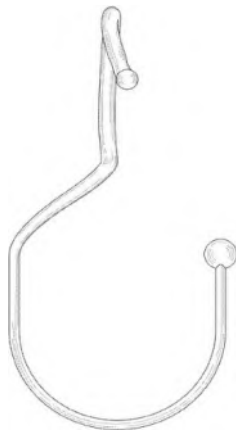

FIG. 5

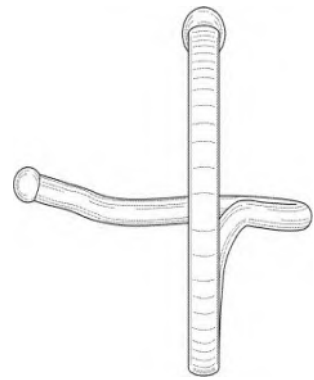

FIG. 6

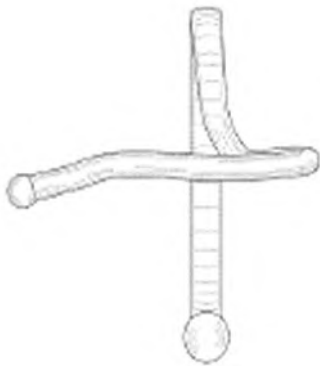

FIG. 7

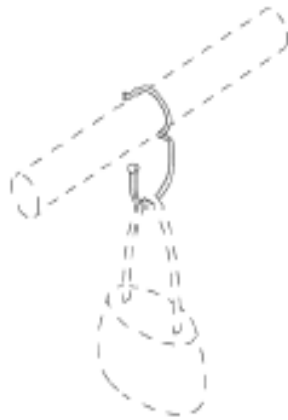

FIG. 8



26. The prosecution of the '526 patent does not include activity or actions which would in any way narrow the scope of the patented design or affect its claim construction. Thus, the claim construction of the '526 patent is based primarily upon the patent itself. Considering the overall visual impression given by these drawings, I construe the claim of the '526 patent, based upon the drawings therein, from the perspective of a person of ordinary skill in the art of handbag hanger hooks, as the design for a handbag hanger hook as illustrated in FIG. 1-8 of the '526 Patent, with the understanding that functional elements or features are to be discounted and only ornamental features included. Also, although detailed descriptions of the patented design are disfavored in claim construction, I have set forth below a written description of the patented design, which may be used in claim construction. The patented design includes the following ornamental elements, generally described:

- (a) When viewed from the front, a generally hook shaped top portion with a slight flare near the tip of the top portion, the top portion having a fairly consistent radius, and the hook portion terminating in a bulbous-shaped-type-tip. The top portion is connected to a bottom portion which is rotated ninety degrees from the top portion causing the bottom portion to appear substantially as a straight line from the front. The bottom portion also terminates in a bulbous-shaped-type-tip;
- (b) When viewed from the side, the top portion appears as a substantially straight vertical line formed by a rear section of the top portion with a very slight curvature with a partially visible front section which extends at an angle from the rear section which terminates in a bulbous-shaped-type-tip. The top portion is connected to the bottom portion by an angled offset section in the plane of the bottom portion. The bottom portion is generally U-shaped and terminates in a bulbous-shaped-type-tip;
- (c) When viewed from the top, the design has a generally cross shape, in which the bottom portion appears as a generally straight line terminating in a bulbous-shaped-type-tip, and in which the top portion appears as a generally straight line which is perpendicular to the bottom portion. The top portion includes a small flare near one end which terminates in a bulbous-shaped-type-tip. A slight offset with a curvature connects the top portion and the bottom portion; and
- (d) The overall form of the design is a hooked top portion in the shape of the top half of an "S," which is connected to a substantially U-shaped bottom portion rotated ninety degrees from the top portion. The top portion is connected to the bottom

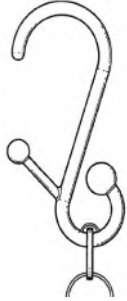
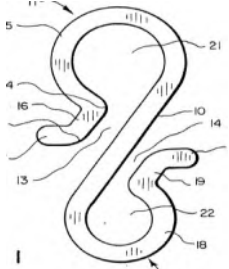

portion by an offset section extending at an angle in the plane of the bottom portion. Both terminal ends of the design terminate in bulbous-shaped-type-tips.

Infringement

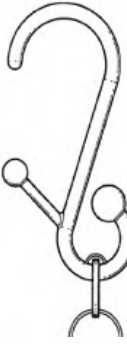
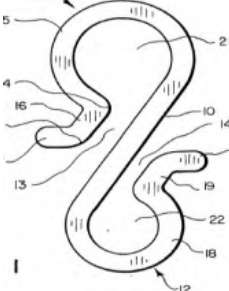

27. To perform my infringement analysis, I viewed the accused articles, including from the same perspectives as the drawings claimed in the '526 patent. Photographs of the accused articles are included in **Exhibits H-K**. Comparisons of the accused articles, the patented design, and the closest prior art designs are included in **Exhibits Q-T**
28. I then compared the patented design as shown in the '526 patent drawings as construed herein with the accused design to determine whether an ordinary, non-expert observer would consider them to be substantially similar to each other.
29. I further determined what effect the consideration of prior art designs would have on the impressions formed by comparing the patented design with the accused articles. To do this, I reviewed the references cited in the file history of the '526 patent. Among the designs, I considered the embodiments taught in United States Patent No. D560,924 (see **Exhibit C**) (hereinafter the '924 patent) and United States Patent No. 5,575,446 (see **Exhibit D**) (hereinafter the '446 patent) to be the most similar to the invention claimed in the '526 patent. The '924 and '446 patents are thus used for the analysis as the closest comparative designs found among the references cited in the file history of the '526 patent.
30. Table 1, *infra*, compares first side views of a first embodiment claimed in the '526 patent with photographs of Defendant's accused Product Type 1, in view of the embodiments taught in the '924 and '446 patents, respectively. A more comprehensive comparison of these designs showing alternative views can be found in **Exhibit Q**.

THE CLOSEST COMPARATIVE DESIGNS, THE DESIGN CLAIMED IN THE '526 PATENT, AND DEFENDANTS' INFRINGING PRODUCT TYPE 1				
	'924 Design	'446 Design	Patented Design	Infringing Product Type 1
First Side				

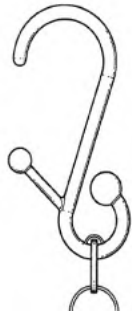
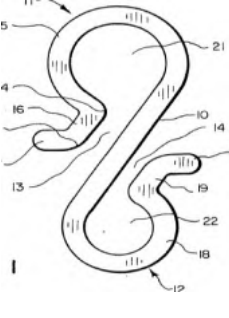

31. Table 2, *infra*, compares first side views of a first embodiment claimed in the '526 patent with photographs of Defendant's accused Product Type 2, in view of the embodiments taught in the '924 and '446 patents, respectively. A more comprehensive comparison of these designs showing alternative views can be found in **Exhibit R**.

THE CLOSEST COMPARATIVE DESIGNS, THE DESIGN CLAIMED IN THE '526 PATENT, AND DEFENDANTS' INFRINGING PRODUCT TYPE 2				
	'924 Design	'446 Design	Patented Design	Infringing Product Type 2
First Side				

32. Table 3, *infra*, compares first side views of a first embodiment claimed in the '526 patent with photographs of Defendant's accused Product Type 3, in view of the embodiments taught in the '924 and '446 patents, respectively. A more comprehensive comparison of these designs showing alternative views can be found in **Exhibit S**.

THE CLOSEST COMPARATIVE DESIGNS, THE DESIGN CLAIMED IN THE '526 PATENT, AND DEFENDANTS' INFRINGING PRODUCT TYPE 3				
	'924 Design	'446 Design	Patented Design	Infringing Product Type 3
First Side				

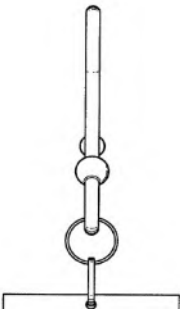
33. Table 4, *infra*, compares front views of a first embodiment claimed in the '526 patent with photographs of Defendant's accused Product Type 4, in view of the embodiments taught in the '924 and '446 patents, respectively. A more comprehensive comparison of these designs showing alternative views can be found in **Exhibit T**.

THE CLOSEST COMPARATIVE DESIGNS, THE DESIGN CLAIMED IN THE '526 PATENT, AND DEFENDANTS' INFRINGING PRODUCT TYPE 4				
	'924 Design	'446 Design	Patented Design	Infringing Product Type 4
Front		N/A		

34. As is readily apparent, the designs of the accused articles are substantially similar, if not virtually identical, to the design claimed by the '526 patent. And, the differences between the patented design and the comparative prior art designs are substantial. A non-exhaustive set of examples of ornamental design features shared by the patented design and the accused articles includes:

- (a) When viewed from the front, the patented design and the accused articles exhibit a generally hook shaped top portion having a fairly consistent radius, the hook portion terminating in a bulbous-shaped-type-tip. The top portion is connected to a bottom portion which is rotated ninety degrees from the top portion, causing the bottom portion to appear substantially as a straight line from the front. The bottom portion also terminates in a bulbous-shaped-type-tip;
- (b) When viewed from the side, the top portion appears as a substantially straight line which terminates in a bulbous-shaped-type-tip. The top portion is connected to the bottom portion by an offset in the plane of the bottom portion. The bottom portion is generally U-shaped and terminates in a bulbous-shaped-type-tip;
- (c) When viewed from the top, a generally cross shape, in which the bottom portion appears as generally a straight line terminating in a bulbous-shaped-type-tip, and in which the top portion appears as a generally straight line which is perpendicular to the bottom portion. The top portion terminates in a bulbous-shaped-type-tip. A slight offset connects the top portion and the bottom portion; and
- (d) The overall form of the patented design and the infringing designs is a hooked top portion in the shape of the top half of an "S," which is connected to a substantially U-shaped bottom portion rotated ninety degrees from the top portion. The top portion is connected to the bottom portion by an offset in the plane of the bottom portion. Both terminal ends of the designs terminate in bulbous-shaped-type-tips.

35. Thus, the overall appearance of the accused articles is, if not virtually identical, at least

so similar to the design claimed in the '526 patent that, in my opinion, in light of the prior art, an ordinary observer would be unlikely to differentiate between them. In arriving at my opinion, I have construed the entirety of the design as indicated herein as being non-functional. However, even if there are functional components, my opinion of infringement would not change as an ordinary observer would still be unlikely to differentiate the overall appearance between the accused and patented designs. Although there are some differences between each of the accused articles and the patented design, these differences are insubstantial as they do not significantly affect the appearance of the overall design. Thus, although not entirely identical, the accused articles are substantially the same as the patented design.

36. Even though some features of the design may perform a function, those features are not considered “functional” as the term is used with respect to design patents. Specifically, the patented design is not dictated by its use or purpose. Any function which may be performed by features of the patented design can be accomplished equivalently by a number of different designs. For example, the function of holding a handbag on a hanger can be performed by numerous alternative designs other than the patented design, such as the handbag hanger hook designs found in the '924 and '446 patents. Because both of these alternative designs can function in the same manner as the patented design in holding a handbag, there is no utilitarian reason for the specific design choices in the patented design, and those choices are considered ornamental. These choices include, among other features, the ninety-degree rotation between the top portion and bottom portion of the patented design, the slight offset in the plane of the bottom portion, and the bulbous-shaped-type-tips. Furthermore, even if the purpose of the patented design includes holding a handbag on a bar or similar structure at a ninety degree angle from the bar, the patented design is not functional. The size and shape of the parts of the handbag hanger hook can be changed and still function identically to the patented design. For example, the bottom section of the design could be of different shapes or proportions, such as square or V-shaped or a modified square or V-shape, and still function similarly, while looking substantially different than the patented design. Thus, due to the presence of numerous different designs which can equally accomplish the same function as the patented design, the patented design is not dictated by its function as a handbag hanger hook and is thus non-functional.

37. It is therefore my opinion that the overall design claimed in the `526 patent is not functional, and Defendants are infringing the `526 patent.

V. VALIDITY OF THE `526 PATENT

38. To perform my validity analysis, I considered the `526 patent, its prosecution history, and all of the references cited therein.

39. Notably, the examiner issued no objections to the patentability of the patented design during examination and issued a Notice of Allowance as a first action, requiring only a minor Examiner's amendment to the figure descriptions in the application for clarity purposes.

40. Like the examiner, I too considered all of the references cited in the `526 patent and, again like the examiner, am of the opinion that the ornamental features of the patented design are novel and nonobvious.

41. To determine novelty of the `526 patent, I ascertained whether an ordinary observer would have found the overall visual impression of the patented design and any design taught within a single prior art reference to be so substantially similar as to mistake one for the other. None of the references considered individually teaches a design with an overall appearance that is so substantially similar to the design claimed in the `526 patent that an ordinary observer would confuse one for the other. Therefore, it is my opinion that the design claimed in the `526 patent is novel and the patent is not invalid for anticipation.

42. To determine nonobviousness of the `526 patent I first determined the scope and content of the prior art. I next considered the level of ordinary skill in the art of handbag hanger hooks. I further considered the differences between the prior art and the design claimed in the `526 patent. I further considered whether, at the time the patented design was invented, it would have been obvious to a designer of handbag hanger hooks, possessing ordinary skill in the art, to combine the prior art references to make a design that is claimed by the `526 patent. The prior art references I considered were those cited in the `526 patent and considered by the examiner during prosecution. It is my opinion that these references do not collectively teach all of the features of the design claimed in the `526 patent such that, at the time the patented design was invented, it would have been obvious for a designer of handbag hanger

hooks possessing ordinary skill to combine the teachings of these references to create the patented design. It is therefore my opinion that the design claimed in the `526 patent is nonobvious and is not invalid for obviousness, over the references cited in the `526 patent.

43. Based on the information received as set forth herein, my opinion is therefore that the `526 patent is valid.
44. I further declare under the penalty of perjury that the statements made herein are true to the best of my knowledge.

Dated: November 20, 2023

/s/Nicholas Mesiti
Nicholas Mesiti, Esq.

EXHIBIT A
MESITI DECLARATION
Curriculum Vitae of Nicholas Mesiti, Esq.

NICHOLAS MESITI
Heslin Rothenberg Farley & Mesiti P.C.
5 Columbia Circle
Albany, New York 12203
(518) 452-5600

PROFESSIONAL

EXPERIENCE: Member and Shareholder: *Heslin Rothenberg Farley & Mesiti P.C.*, Albany, New York. Practice of Intellectual Property law including patent, trademark, copyright and unfair competition law with emphasis on utility patent, design patent, trademark, and copyright litigation before federal district courts, state courts, and Federal Courts of Appeals. Specific projects have included representation of clients in appeals; trial of cases before federal and state courts for purposes of permanent injunctions, preliminary injunctions, accountings and damages; preparation and argument of various pretrial dispositive and non-dispositive motions; all aspects of discovery; and pleading preparation; counseling of clients in various intellectual property matters; licensing; representation in inter-parties proceedings before the United States Patent and Trademark Office; rendering of registrability, patentability and infringement opinions for patents and trademarks; U.S. patent, trademark and copyright application preparation and prosecution; international patent prosecution pursuant to the Patent Cooperation Treaty; international patent and trademark docket and prosecution management; supervision and training of associates. 1990-Present.

Associate Attorney: *Brumbaugh, Graves, Donohue & Raymond*, New York, New York. Specialized in all aspects of Intellectual Property Law including patent, trademark, copyright and unfair competition litigation including appeals; preparation and negotiation of license agreements and other transfers of intellectual property rights; counseling of client; rendering of patentability and infringement opinions; rendering of trademark registrability opinions and copyrightability opinions; preparation and prosecution of patent applications including docket management of patent file wrappers. 1988-1990.

EDUCATION:

ALBANY LAW SCHOOL OF UNION UNIVERSITY, Albany, New York.
Juris Doctor, 1988.
Top 21 Percent of Class.

RENSSELAER POLYTECHNIC INSTITUTE, Troy, New York.
Bachelor of Science, Mechanical Engineering, 1985.
Top 15 Percent of Class.

COURTS ADMITTED:

UNITED STATES COURT OF APPEALS FOR THE FOURTH CIRCUIT, 2005

UNITED STATES COURT OF APPEALS FOR THE SECOND CIRCUIT, 1993

UNITED STATES COURT OF APPEALS FOR THE FEDERAL CIRCUIT, 1990.

UNITED STATES DISTRICT COURTS: WESTERN DISTRICT OF MICHIGAN, 2000;
NORTHERN DISTRICT OF NEW YORK, 1989; SOUTHERN DISTRICT OF NEW
YORK, 1989; EASTERN DISTRICT OF NEW YORK, 1989.

NEW YORK STATE, 1989.

UNITED STATES PATENT AND TRADEMARK OFFICE;
Registered Agent, 1988; Attorney, 1989.

REPORTED CASES:

1. Advanced Fiber Technologies (AFT) Trust v. J&L Fiber Services, Inc.,
674 F.3d 1365 (Fed. Cir. 2012)
2. Deere & Co. v. International Trade Commission, 605 F.3d 1350 (Fed. Cir. 2010)
3. Levine v. Landy, ___ F.Supp. ___, 2012 Copr. L. Dec. 181 2011 WL 6845886, N.D.N.Y.
Dec. 30, 2011 (11-CV-1038)
4. CommScope, Inc. of North Carolina v. Commscope (U.S.A.) Intern. Group Co., Ltd.,
809 F. Supp. 2d 33, (N.D.N.Y. 2011).
5. ATI Indus. Automation, Inc. v. Applied Robotics, Inc.,
801 F.Supp. 2d 419 (M.D.N.C. 2011)
6. Universal Furniture Intern., Inc. v. Collezione Europa USA, Inc.,
618 F.3d 417 (4th Cir. 2010)
7. Advanced Fiber Technologies (AFT) Trust v. J&L Fiber Services, Inc.,
751 F. Supp. 2d 348 (N.D.N.Y. 2010)
8. Universal Furniture Intern., Inc. v. Collezione Europa, U.S.A., Inc.,
599 F.Supp. 2d 648 (M.D.N.C. 2009)
9. Amini Innovation Corp. v. Bank & Estate Liquidators, Inc., 512 F.Supp.2d 1039, 2007

WL 1795855, (S.D. Tex. 2007)

10. Bourdeau Bros., Inc. v. International Trade Comm'n, 444 F.3d 1317, (Fed. Cir. 2006)
11. Bernhardt, L.L.C. v. Collezione Europa USA, Inc., 386 F.3d 1371, 2004 WL 2397341, 72 U.S.P.Q.2d 1901, (Fed. Cir. 2004).
12. Fusco Group, Inc. v. Loss Consultants Intern., Inc., 462 F.Supp.2d 321, 2006 WL 3365681 (N.D.N.Y. 2006)
13. Bernhardt L.L.C. v. Collezione Europa USA, Inc., 436 F.Supp.2d 739 2006 WL 1876517, (M.D.N.C. 2006)
14. Bernhardt L.L.C. v. Collezione Europa USA, Inc., 422 F.Supp.2d 561, 2006 WL 771892, (M.D.N.C. 2006)
15. Harvest Technologies Corp. v. Cytomedix, Inc., 2004 WL 2009253 (D.Mass. 2004) (No. Civ. A. 02-12077-PBS).
16. Landscape Forms, Inc. v. Columbia Cascade Co., 113 F.3d 373 (2nd Cir. 1997)
17. Landscape Forms, Inc. v. Columbia Cascade Co., 1996 U.S. Dist. Lexis 15420 (S.D.N.Y.).
18. L. & J.G. Stickley, Inc. v. Canal Dover Furniture Co., 79 F.3d 258 (2nd Cir. 1996).
19. Landscape Forms, Inc. v. Columbia Cascade Co., 70 F.3d 251 (2nd Cir. 1995).
20. Tough Traveler, Ltd. v. Outbound Products, 60 F.3d 964 (2nd Cir. 1995).
21. Imagineering, Inc. v. Van Klassens, Inc., 53 F.3d 1260 (Fed. Cir. 1995).
22. L. & J.G. Stickley, Inc. v. Canal Dover Furniture Co., 892 F. Supp. 413 (N.D.N.Y. 1995).
23. Imagineering, Inc. v. Van Klassens, Inc., 155 F.R.D. 68 (S.D.N.Y. 1994).
24. Imagineering, Inc. v. Van Klassens, Inc., 851 F. Supp. 532 (S.D.N.Y. 1994).
25. Imagineering, Inc. v. Van Klassens, Inc., 797 F. Supp. 329 (S.D.N.Y. 1992).
26. Zenith v. Brad Cable Electronics, 1991 U.S. Dist. Lexis 6366, (N.D.N.Y.).

27. State University of New York v. Triple O, LLC, 2020 WL 6196152 (N.D.N.Y. 2020) (No. 1:19-cv-1385 GLS/DJS).
28. State University of New York v. Triple O, LLC, 2021 WL 3287774 (N.D.N.Y. 2021) (No. 1:19-cv-1385 GLS/DJS).
29. Research Foundation for State University of New York v. Telluric Labs, LLC, 2022 WL 16789970 (E.D.N.Y. 2022).
30. CVD Equipment Corp. v. PrecisionFlow Technologies, Inc., 2007 WL 1571666 (N.D.N.Y. 2007).
31. S.F.X. Broadcasting of New York, Inc. v. Radio Enterprises, Inc., 1997 WL 599351 (N.D.N.Y. 1997).
32. Doctor's Associates Inc. v. Neverett, 2010 WL 11541815 (N.D.N.Y. 2010).
33. Rensselaer Polytechnic Institute v. Apple Inc., 2014 WL 12586845 (N.D.N.Y. 2014).
34. L.M. Sessler Excavating and Wrecking, Inc. v. Bette & Cring, LLC, 2017 WL 4652709 (W.D.N.Y. 2017).
35. Tower Products Inc. v. Laird Enterprises Inc., 2020 WL 3453552 (N.D.N.Y. 2020).
36. Levine v. Landy, 860 F.Supp.2d 184 (N.D.N.Y. 2012).
37. Research Foundation for State University of New York v. Telluric Labs, LLC, 2023 WL 6307995 (E.D.N.Y. 2023).
38. Research Foundation for State University of New York v. Telluric Labs, LLC, 2021 WL 9678645 (E.D.N.Y. 2021).
39. Verbal Judo Institute, Inc. v. Vistelar, LLC, 2018 WL 8800685 (N.D.N.Y. 2018).
40. Rensselaer Polytechnic Institute v. Apple Inc., 2014 WL 1871866 (N.D.N.Y. 2014).
41. Plump Engineering, Inc. v. Westshore Design Engineers, P.C., 2018 WL 3730168 (N.D.N.Y. 2018).
42. Rensselaer Polytechnic Institute v. Apple Inc., 2014 WL 201965 (N.D.N.Y. 2014).
43. Worldwide Sport Nutritional Supplements, Inc. v. Five Star Brands, LLC, 80 F.Supp.2d 25 (N.D.N.Y. 1999).
44. Worldwide Sport Nutritional Supplements, Inc. v. Van Horn Technologies, Inc., 1977 WL 698044 (N.D.N.Y. 1997).

45. Fusco Group, Inc. v. Loss Consultants Intern., Inc., 462 F.Supp.2d 321 (N.D.N.Y. 2006).
46. Charles Ramsey Company, Inc. v. Fabtech-NY LLC, 2020 WL 352614.
47. Albany Medical College v. Smiths Medical Asd, Inc., 2014 WL 10137686 (N.D.N.Y. 2014).
48. Albany Medical College v. Smiths Medical ASD, Inc., 2015 WL 58221 (N.D.N.Y. 2015).

PUBLICATIONS:

Co-Author, *A Report of the Recent Trade Dress Cases Within the Second Circuit*, 1995,
American Intellectual Property Law Association, Trademark and Unfair Competition
Committee.

Co-Author, *Federal Circuit Patent Law Decisions* 1988, Section 112 Update, published by
American Intellectual Property Law Association.

Co-Author, *Separate Juries for Liability and Damages in Patent Cases*, New York Law Journal,
November 22, 1988.

PROFESSIONAL AFFILIATIONS:

International Trademark Law Association.

American Intellectual Property Law Association.

American Bar Association.

New York State Bar Association, Intellectual Property Law Section

Albany County Bar Association.

American Society of Mechanical Engineers.

HONORS AND ACHIEVEMENTS:

Pi Tau Sigma

Rensselaer Engineering and Science Award

Rensselaer Scholarship

Dean's List, Presidential Honors

LANGUAGES: Italian.

EXHIBIT B
Mesiti Declaration
U.S. Design Patent No. D695,526
With File Wrapper History and
Cited References



US00D695526S

(12) **United States Design Patent**
Easlick

(10) **Patent No.:** **US D695,526 S**

(45) **Date of Patent:** **** Dec. 17, 2013**

(54) **HANDBAG HANGER HOOK**

Primary Examiner — Holly Baynham

(76) Inventor: **Jacklyn S Easlick**, Rye, NY (US)

(74) *Attorney, Agent, or Firm* — Sinorica, LLC

(**) Term: **14 Years**

(57) **CLAIM**

The ornamental design for a handbag hanger hook, as shown and described.

(21) Appl. No.: **29/431,801**

(22) Filed: **Sep. 11, 2012**

DESCRIPTION

(51) **LOC (9) Cl.** **03-01**

(52) **U.S. Cl.**
USPC **D3/328; D8/367**

(58) **Field of Classification Search**
USPC **D3/328; D8/367; 248/302–303**
See application file for complete search history.

FIG. 1 is a perspective view of the handbag hanger hook;
FIG. 2 is a front elevational view thereof;
FIG. 3 is a rear elevational view thereof;
FIG. 4 is a right-side elevational view thereof;
FIG. 5 is a left-side elevational view thereof;
FIG. 6 is a bottom plan view thereof;
FIG. 7 is a top plan view thereof; and,
FIG. 8 is a reduced scale perspective view thereof wherein the top hook is hung on a rod, with a handbag hanging from the bottom hook.

The broken line showing the rod and handbag in FIG. 8 is included for the purpose of showing environmental structure and forms no part of the claimed design.

(56) **References Cited**

U.S. PATENT DOCUMENTS

5,575,446	A *	11/1996	Swenson et al.	248/304
D475,278	S *	6/2003	Williams	D8/367
D493,092	S *	7/2004	Kalat	D8/367
D560,924	S *	2/2008	Walker	D6/396
D644,438	S *	9/2011	Brucker	D3/328

* cited by examiner

1 Claim, 8 Drawing Sheets

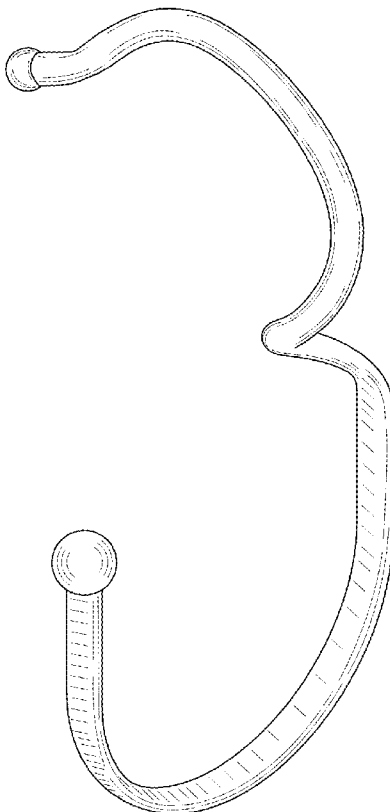

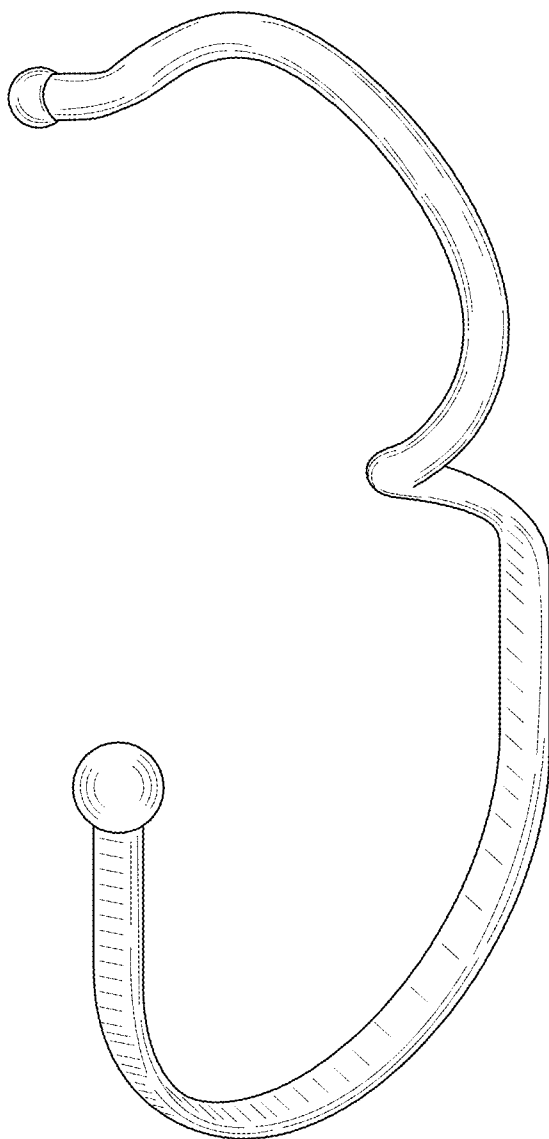

FIG. 1

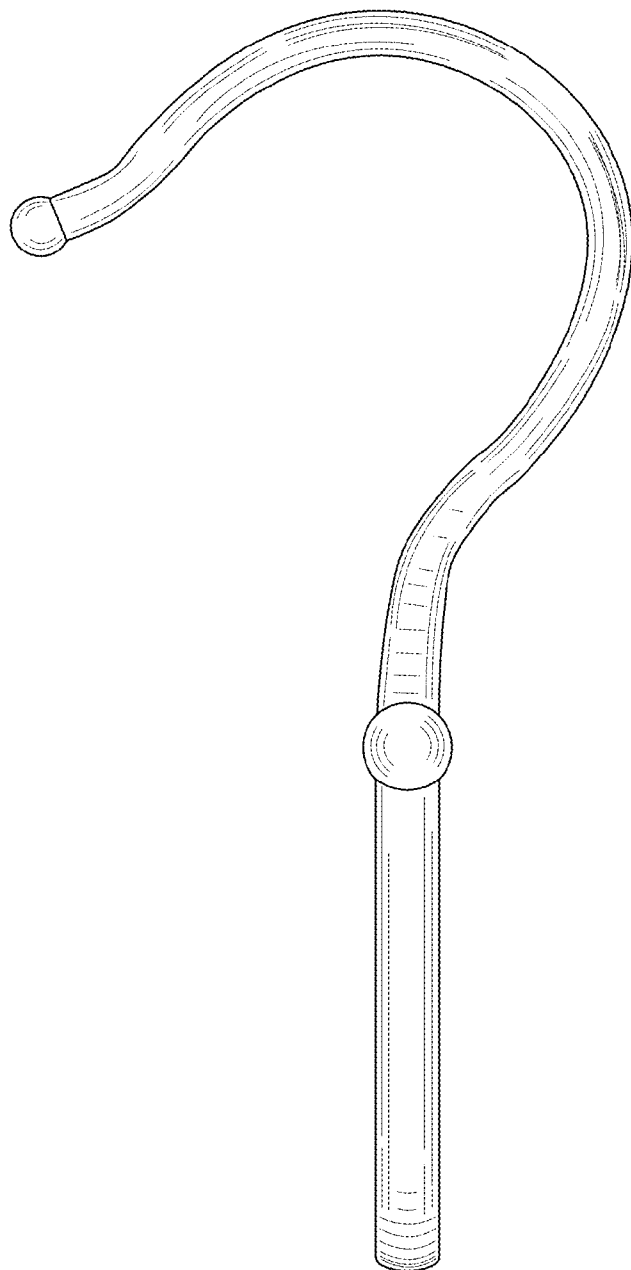

FIG. 2

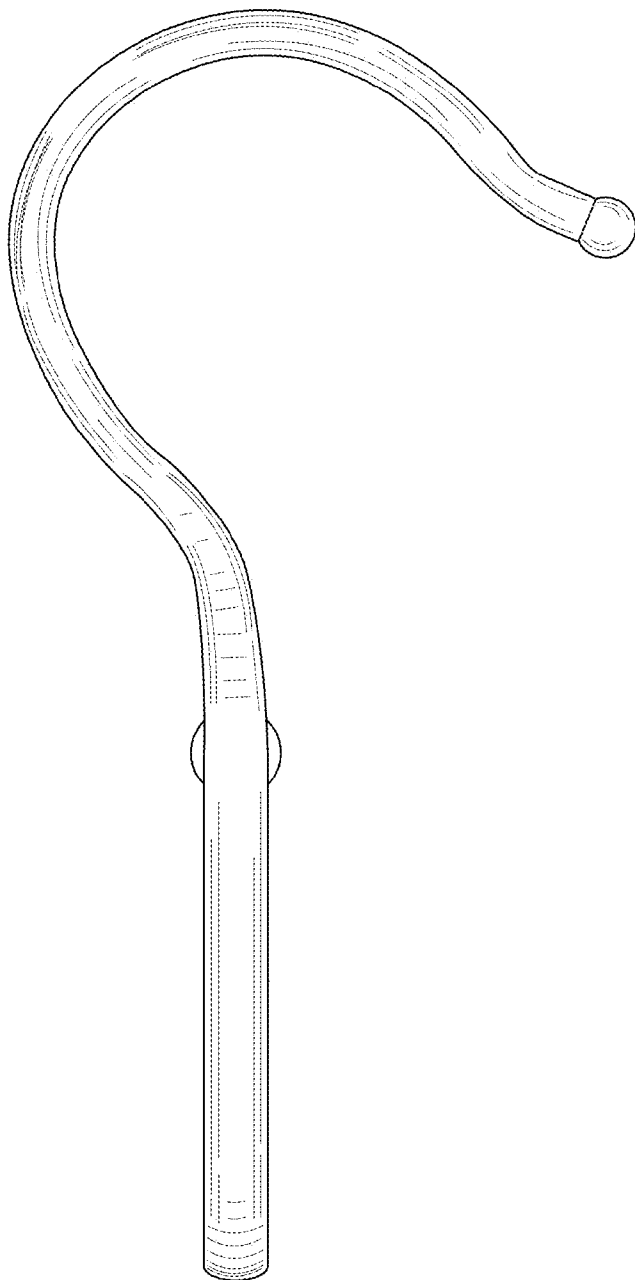

FIG. 3

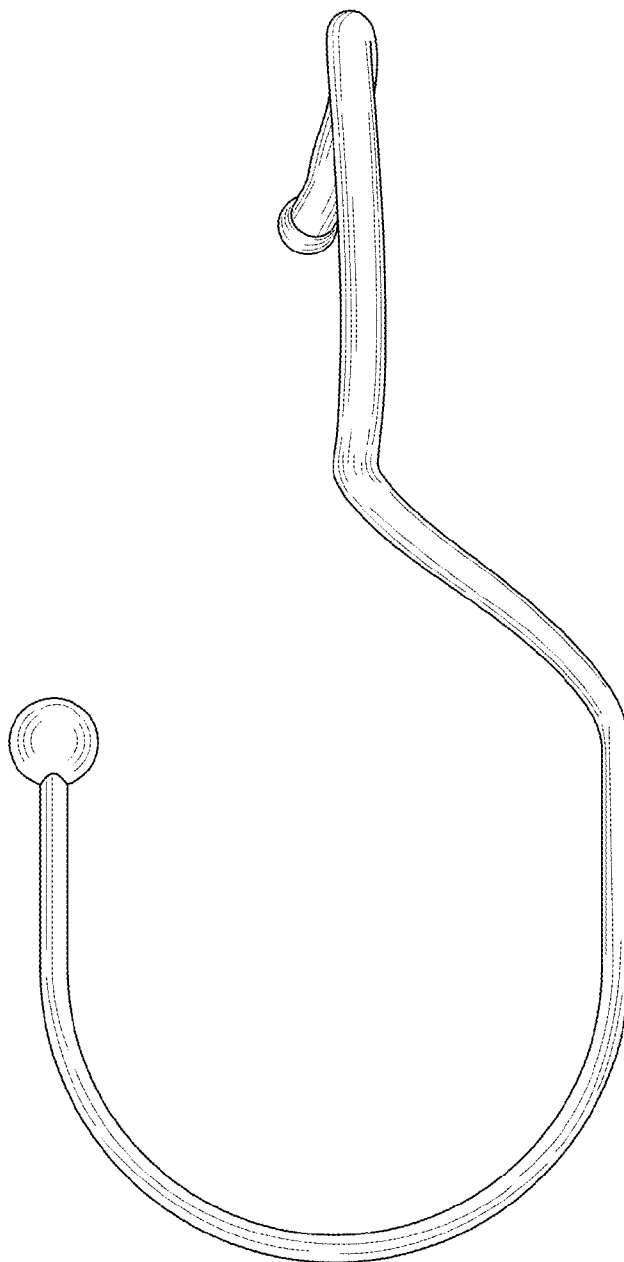

FIG. 4

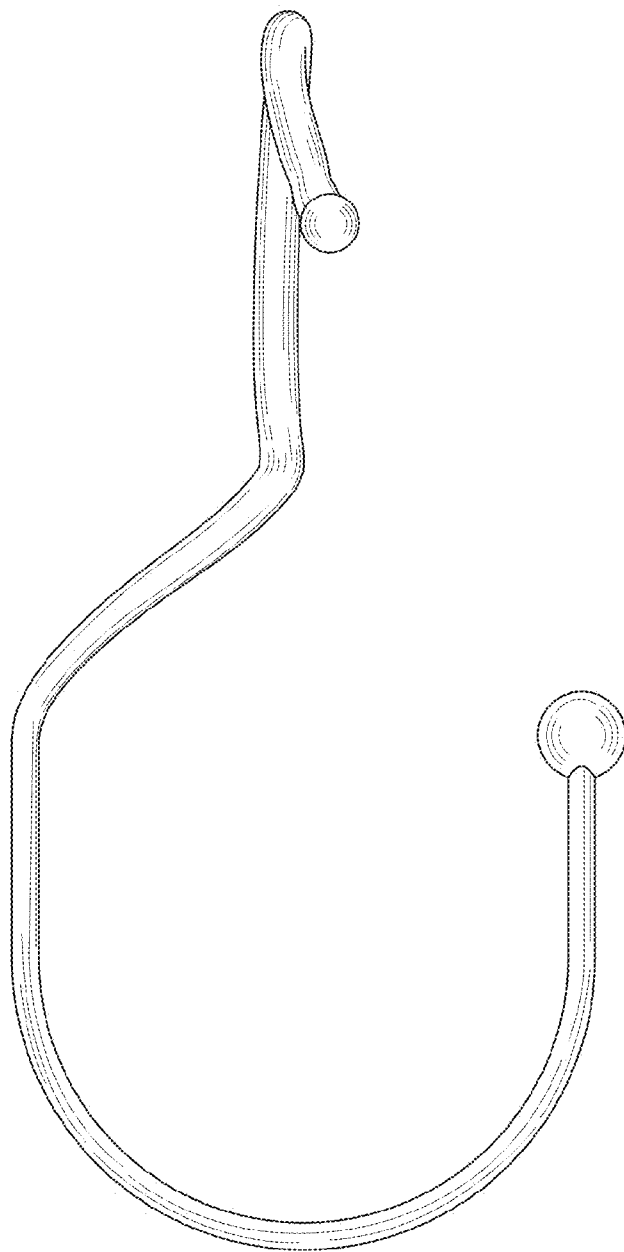

FIG. 5

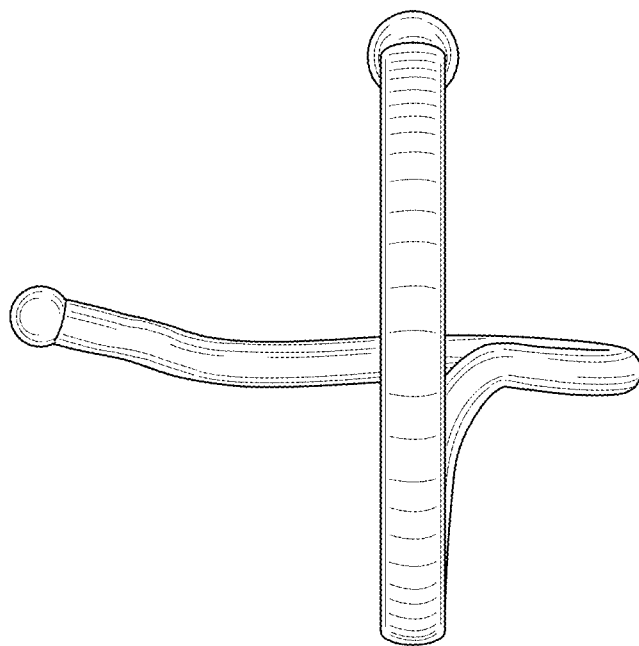

FIG. 6

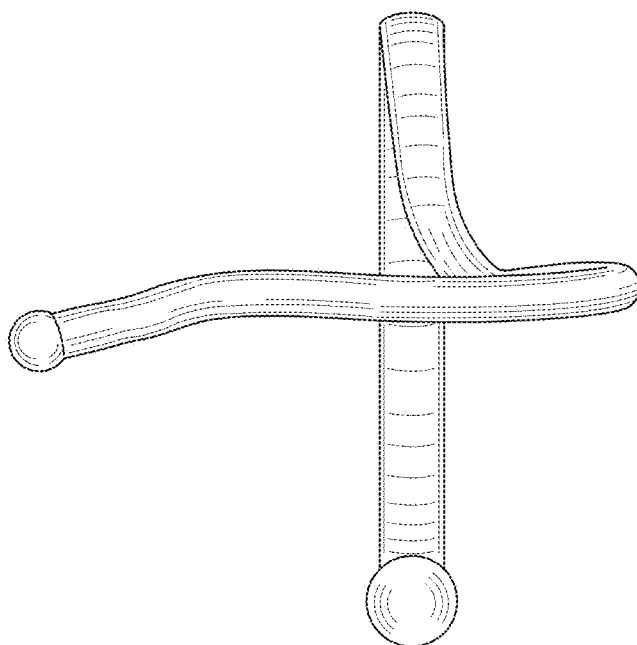

FIG. 7

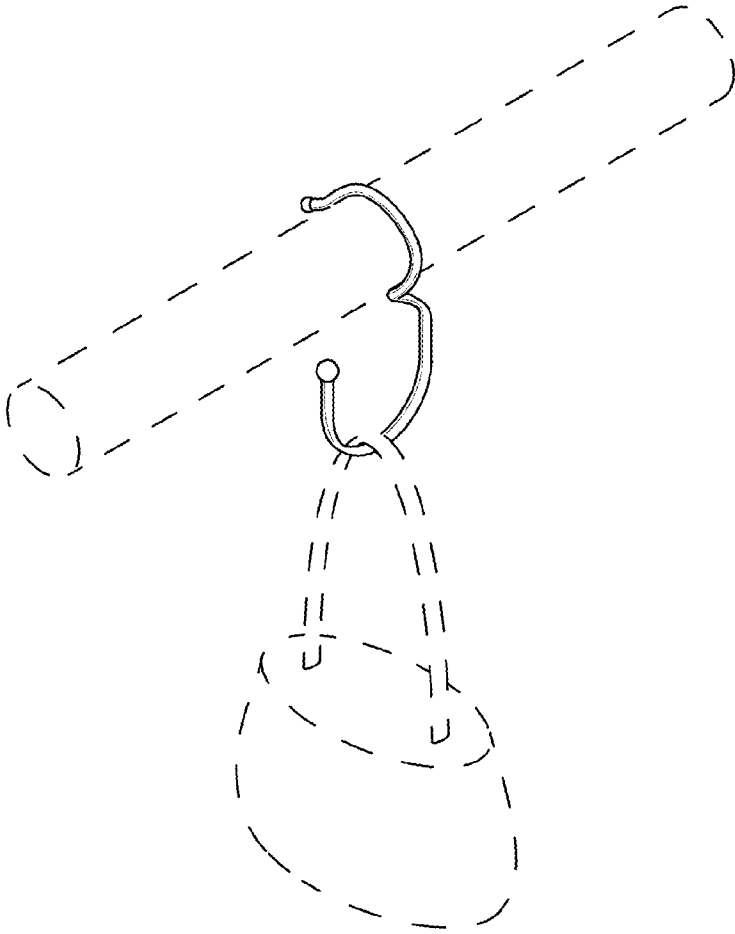

FIG. 8

File Wrapper

(First Action Allowance)

PATENT ASSIGNMENT COVER SHEET

Electronic Version v1.1
 Stylesheet Version v1.2

EPAS ID: PAT7141526

SUBMISSION TYPE:	NEW ASSIGNMENT
NATURE OF CONVEYANCE:	ASSIGNMENT
CONVEYING PARTY DATA	
Name	Execution Date
JACKLYN S EASLICK	01/25/2022
RECEIVING PARTY DATA	
Name:	JE CORPORATE LLC
Street Address:	138A EAST PARK AVENUE
City:	LONG BEACH
State/Country:	NEW YORK
Postal Code:	11561
PROPERTY NUMBERS Total: 1	
Property Type	Number
Patent Number:	D695526
CORRESPONDENCE DATA	
Fax Number:	
<i>Correspondence will be sent to the e-mail address first; if that is unsuccessful, it will be sent using a fax number, if provided; if that is unsuccessful, it will be sent via US Mail.</i>	
Email:	Rob@amazonsellerslawyer.com
Correspondent Name:	ROBERT SEGALL
Address Line 1:	138 E PARK AVE STE A
Address Line 4:	LONG BEACH, NEW YORK 11561
NAME OF SUBMITTER:	ROBERT SEGALL
SIGNATURE:	/Robert Segall/
DATE SIGNED:	01/26/2022
	This document serves as an Oath/Declaration (37 CFR 1.63).
Total Attachments: 2	
source=Executed JE Patent Assignment#page1.tif	
source=Executed JE Patent Assignment#page2.tif	

ASSIGNMENT

WHEREAS, I, Jacklyn S Easlick, a citizen residing at 222 Purchase St. #187, Rye, New York, 10580 ("INVENTOR") have invented certain new and useful improvements that are found in a nonprovisional patent application that was filed September 11, 2012 and entitled "Handbag hanger hook";

WHEREAS, JE Corporate LLC, a limited liability company duly organized under the laws of the State of New York, USA and having a place of business at 138A East Park Avenue, Long Beach, New York, 11561, (hereinafter "ASSIGNEE") is desirous of acquiring the entire right, title and interest in and to the aforesaid inventions and in and to any Letters Patent of the United States or any foreign country which may be granted therefor;

NOW THEREFORE, for good and valuable consideration, the receipt and sufficiency of which is hereby acknowledged, INVENTOR hereby sells, assigns and transfers to the ASSIGNEE, its successors and assigns, the entire right, title and interest for all countries in and to the invention disclosed in the aforesaid application, and in and to the said application, all divisionals, continuations, continuations-in-part, and renewals thereof, all rights to claims of and for any right of priority for said application or patent, all Letters Patent which may be granted therefrom, and all reissues or extensions of such patents, and in and to any and all applications which have been or shall be filed in any foreign countries for Letters Patent on the said invention including an assignment of all rights under the provisions of the International Convention, and all Letters Patent of foreign countries which may be granted therefrom; and INVENTOR hereby authorizes and requests the Commissioner of Patents to issue any and all United States Letters Patent for the aforesaid invention to the ASSIGNEE of the entire right, title and interest in and to the same, for the use of the ASSIGNEE, its successors and assigns.

INVENTOR hereby agrees that INVENTOR, his executors and legal representatives will make, execute and deliver (without charge but at the expense of the ASSIGNEE) any and all other instruments in writing including any and all further application papers, affidavits, assignments and other documents, and will communicate to said ASSIGNEE, its successors and representatives all facts known to INVENTOR relating to said invention and the history thereof and will testify in all legal proceedings and generally do all things which may be necessary or desirable to vest in the ASSIGNEE, its successors or assigns the entire right, title and interest in and to the said invention, applications, Letters Patent, rights, titles, benefits, privileges and advantages hereby sold, assigned and conveyed, or intended so to be.

INVENTOR represents and agrees with said ASSIGNEE its successors and assigns, that no assignment, grant, mortgage, license or other agreement affecting the rights and property herein conveyed has been or will be made to others by INVENTOR, and that full right to convey the same as herein expressed is possessed by INVENTOR.

INVENTOR hereby authorizes and requests the insertion in the following parenthetical (Application No. USD695526S, filed September 11, 2012) the application number and filing date of the above-identified patent application when such information is known if such information is not already provided herein.

THEREBY authorize and request the Commissioner of Patents and Trademarks or any other proper officer or agency of any country to issue all said Letters Patent to ASSIGNEE;

I HEREBY warrant and covenant that: (a) I have full right to convey the entire interest herein assigned and that have not executed and will not execute any instrument or assignment in conflict herewith; (b) the above-identified application was made or authorized to be made by me; and (c) I believe I am the original and sole inventor of a claimed invention in the application; and

I HEREBY acknowledge that any willful false statement made herein is punishable under 18 U.S.C. 1001 by fine or imprisonment of not more than five (5) years, or both;

IN TESTIMONY WHEREOF, I have hereunto set my hand and seal.

Date: 1.25.22 Inventor: Jacklyn S Easlick
Jacklyn S Easlick

[Note: No legalization or other witness required]

ASSIGNMENT ACCEPTED on behalf of the ASSIGNEE:

1.25.22 Jacklyn S Easlick
Date Signature
Jacklyn Easlick
Printed Name
Member
Title or Position



UNITED STATES PATENT AND TRADEMARK OFFICE

UNITED STATES DEPARTMENT OF COMMERCE
United States Patent and Trademark Office
Address: COMMISSIONER FOR PATENTS
P.O. Box 1450
Alexandria, Virginia 22313-1450
www.uspto.gov

APPLICATION NO.	ISSUE DATE	PATENT NO.	ATTORNEY DOCKET NO.	CONFIRMATION NO.
29/431,801	12/17/2013	D695526	TP-EASJ-HIA2	3337

62439 7590 11/26/2013
SINORICA, LLC
19785 Crystal Rock Drive
Suite 207
Germantown, MD 20874

ISSUE NOTIFICATION

The projected patent number and issue date are specified above.

Determination of Patent Term Extension or Adjustment under 35 U.S.C. 154 (b)

Design patents have a term measured from the issue date of the patent and the term remains the same length regardless of the time that the application for the design patent was pending. Since the above-identified application is an application for a design patent, the patent is not eligible for Patent Term Extension or Adjustment under 35 U.S.C. 154(b).

Any questions regarding the Patent Term Extension or Adjustment determination should be directed to the Office of Patent Legal Administration at (571)-272-7702. Questions relating to issue and publication fee payments should be directed to the Application Assistance Unit (AAU) of the Office of Data Management (ODM) at (571)-272-4200.

APPLICANT(s) (Please see PAIR WEB site <http://pair.uspto.gov> for additional applicants):

Jacklyn S. EASLICK, Rye, NY;

The United States represents the largest, most dynamic marketplace in the world and is an unparalleled location for business investment, innovation, and commercialization of new technologies. The USA offers tremendous resources and advantages for those who invest and manufacture goods here. Through SelectUSA, our nation works to encourage and facilitate business investment. To learn more about why the USA is the best country in the world to develop technology, manufacture products, and grow your business, visit SelectUSA.gov.

PART B - FEE(S) TRANSMITTAL

Complete and send this form, together with applicable fee(s), to: **Mail** **Mail Stop ISSUE FEE**
Commissioner for Patents
P.O. Box 1450
Alexandria, Virginia 22313-1450
or Fax (571)-273-2885

INSTRUCTIONS: This form should be used for transmitting the ISSUE FEE and PUBLICATION FEE (if required). Blocks 1 through 5 should be completed where appropriate. All further correspondence including the Patent, advance orders and notification of maintenance fees will be mailed to the current correspondence address as indicated unless corrected below or directed otherwise in Block 1, by (a) specifying a new correspondence address; and/or (b) indicating a separate "FEE ADDRESS" for maintenance fee notifications.

CURRENT CORRESPONDENCE ADDRESS (Note: Use Block 1 for any change of address)

Sinorica, LLC
 19785 Crystal Rock Drive
 Suite 207
 Germantown, MD 20874

Note: A certificate of mailing can only be used for domestic mailings of the Fee(s) Transmittal. This certificate cannot be used for any other accompanying papers. Each additional paper, such as an assignment or formal drawing, must have its own certificate of mailing or transmission.

Certificate of Mailing or Transmission

I hereby certify that this Fee(s) Transmittal is being deposited with the United States Postal Service with sufficient postage for first class mail in an envelope addressed to the Mail Stop ISSUE FEE address above, or being facsimile transmitted to the USPTO (571) 273-2885, on the date indicated below.

(Depositor's name)
(Signature)
(Date)

APPLICATION NO.	FILING DATE	FIRST NAMED INVENTOR	ATTORNEY DOCKET NO.	CONFIRMATION NO.
-----------------	-------------	----------------------	---------------------	------------------

29/431,801	09-11-2012	Jacklyn S. EASLICK	TP-EASJ-HIA2	3337
------------	------------	--------------------	--------------	------

TITLE OF INVENTION:

APPLN. TYPE	SMALL ENTITY	ISSUE FEE DUE	PUBLICATION FEE DUE	PREV. PAID ISSUE FEE	TOTAL FEE(S) DUE	DATE DUE
-------------	--------------	---------------	---------------------	----------------------	------------------	----------

nonprovisional	MICRO	\$255	\$0	\$0	\$255	01/13/2014
----------------	-------	-------	-----	-----	-------	------------

EXAMINER	ART UNIT	CLASS-SUBCLASS
----------	----------	----------------

1. Change of correspondence address or indication of "Fee Address" (37 CFR 1.363).

- Change of correspondence address (or Change of Correspondence Address form PTO/SB/122) attached.
- "Fee Address" indication (or "Fee Address" Indication form PTO/SB/47; Rev 03-02 or more recent) attached. **Use of a Customer Number is required.**

2. For printing on the patent front page, list

- (1) the names of up to 3 registered patent attorneys or agents OR, alternatively, 1 Sinorica, LLC
- (2) the name of a single firm (having as a member a registered attorney or agent) and the names of up to 2 registered patent attorneys or agents. If no name is listed, no name will be printed. 2 _____
- 3 _____

3. ASSIGNEE NAME AND RESIDENCE DATA TO BE PRINTED ON THE PATENT (print or type)

PLEASE NOTE: Unless an assignee is identified below, no assignee data will appear on the patent. If an assignee is identified below, the document has been filed for recordation as set forth in 37 CFR 3.11. Completion of this form is NOT a substitute for filing an assignment.

(A) NAME OF ASSIGNEE (B) RESIDENCE: (CITY and STATE OR COUNTRY)

Please check the appropriate assignee category or categories (will not be printed on the patent): Individual Corporation or other private group entity Government

4a. The following fee(s) are submitted:

- Issue Fee
- Publication Fee (No small entity discount permitted)
- Advance Order - # of Copies _____

4b. Payment of Fee(s): (Please first reapply any previously paid issue fee shown above)

- A check is enclosed.
- Payment by credit card. Form PTO-2038 is attached.
- The Director is hereby authorized to charge the required fee(s), any deficiency, or credit any overpayment, to Deposit Account Number _____ (enclose an extra copy of this form).

5. Change in Entity Status (from status indicated above)

- a. Applicant claims SMALL ENTITY status. See 37 CFR 1.27. b. Applicant is no longer claiming SMALL ENTITY status. See 37 CFR 1.27(g)(2).

NOTE: The Issue Fee and Publication Fee (if required) will not be accepted from anyone other than the applicant; a registered attorney or agent; or the assignee or other party in interest as shown by the records of the United States Patent and Trademark Office.

Authorized Signature /Ming Chow/
 Typed or printed name Ming Chow

Date 10-23-2013
 Registration No. 58531

This collection of information is required by 37 CFR 1.311. The information is required to obtain or retain a benefit by the public which is to file (and by the USPTO to process) an application. Confidentiality is governed by 35 U.S.C. 122 and 37 CFR 1.14. This collection is estimated to take 12 minutes to complete, including gathering, preparing, and submitting the completed application form to the USPTO. Time will vary depending upon the individual case. Any comments on the amount of time you require to complete this form and/or suggestions for reducing this burden, should be sent to the Chief Information Officer, U.S. Patent and Trademark Office, U.S. Department of Commerce, P.O. Box 1450, Alexandria, Virginia 22313-1450. DO NOT SEND FEES OR COMPLETED FORMS TO THIS ADDRESS. SEND TO: Commissioner for Patents, P.O. Box 1450, Alexandria, Virginia 22313-1450.

Under the Paperwork Reduction Act of 1995, no persons are required to respond to a collection of information unless it displays a valid OMB control number.

Privacy Act Statement

The Privacy Act of 1974 (P.L. 93-579) requires that you be given certain information in connection with your submission of the attached form related to a patent application or patent. Accordingly, pursuant to the requirements of the Act, please be advised that: (1) the general authority for the collection of this information is 35 U.S.C. 2(b)(2); (2) furnishing of the information solicited is voluntary; and (3) the principal purpose for which the information is used by the U.S. Patent and Trademark Office is to process and/or examine your submission related to a patent application or patent. If you do not furnish the requested information, the U.S. Patent and Trademark Office may not be able to process and/or examine your submission, which may result in termination of proceedings or abandonment of the application or expiration of the patent.

The information provided by you in this form will be subject to the following routine uses:

1. The information on this form will be treated confidentially to the extent allowed under the Freedom of Information Act (5 U.S.C. 552) and the Privacy Act (5 U.S.C. 552a). Records from this system of records may be disclosed to the Department of Justice to determine whether disclosure of these records is required by the Freedom of Information Act.
2. A record from this system of records may be disclosed, as a routine use, in the course of presenting evidence to a court, magistrate, or administrative tribunal, including disclosures to opposing counsel in the course of settlement negotiations.
3. A record in this system of records may be disclosed, as a routine use, to a Member of Congress submitting a request involving an individual, to whom the record pertains, when the individual has requested assistance from the Member with respect to the subject matter of the record.
4. A record in this system of records may be disclosed, as a routine use, to a contractor of the Agency having need for the information in order to perform a contract. Recipients of information shall be required to comply with the requirements of the Privacy Act of 1974, as amended, pursuant to 5 U.S.C. 552a(m).
5. A record related to an International Application filed under the Patent Cooperation Treaty in this system of records may be disclosed, as a routine use, to the International Bureau of the World Intellectual Property Organization, pursuant to the Patent Cooperation Treaty.
6. A record in this system of records may be disclosed, as a routine use, to another federal agency for purposes of National Security review (35 U.S.C. 181) and for review pursuant to the Atomic Energy Act (42 U.S.C. 218(c)).
7. A record from this system of records may be disclosed, as a routine use, to the Administrator, General Services, or his/her designee, during an inspection of records conducted by GSA as part of that agency's responsibility to recommend improvements in records management practices and programs, under authority of 44 U.S.C. 2904 and 2906. Such disclosure shall be made in accordance with the GSA regulations governing inspection of records for this purpose, and any other relevant (i.e., GSA or Commerce) directive. Such disclosure shall not be used to make determinations about individuals.
8. A record from this system of records may be disclosed, as a routine use, to the public after either publication of the application pursuant to 35 U.S.C. 122(b) or issuance of a patent pursuant to 35 U.S.C. 151. Further, a record may be disclosed, subject to the limitations of 37 CFR 1.14, as a routine use, to the public if the record was filed in an application which became abandoned or in which the proceedings were terminated and which application is referenced by either a published application, an application open to public inspection or an issued patent.
9. A record from this system of records may be disclosed, as a routine use, to a Federal, State, or local law enforcement agency, if the USPTO becomes aware of a violation or potential violation of law or regulation.

CERTIFICATION OF MICRO ENTITY STATUS (GROSS INCOME BASIS)

Application Number or Control Number (if applicable): 29431801	Patent Number (if applicable):
First Named Inventor: Jacklyn S. Easlick	Title of Invention: HANDBAG HANGER HOOK

The applicant hereby certifies the following—

- (1) **SMALL ENTITY REQUIREMENT** - The applicant qualifies as a small entity as defined in 37 CFR 1.27.
- (2) **APPLICATION FILING LIMIT** - Neither the applicant nor the inventor nor a joint inventor has been named as the inventor or a joint inventor on more than four previously filed U.S. patent applications, excluding provisional applications and international applications under the Patent Cooperation Treaty (PCT) for which the basic national fee under 37 CFR 1.492(a) was not paid, and also excluding patent applications for which the applicant has assigned all ownership rights or is obligated to assign all ownership rights as a result of the applicant's previous employment.
- (3) **GROSS INCOME LIMIT ON APPLICANTS AND INVENTORS** - Neither the applicant nor the inventor nor a joint inventor, in the calendar year preceding the calendar year in which the applicable fee is being paid, had a gross income, as defined in section 61(a) of the Internal Revenue Code of 1986 (26 U.S.C. 61(a)), exceeding the "Maximum Qualifying Gross Income" reported on the USPTO website at http://www.uspto.gov/patents/law/micro_entity.jsp which is equal to three times the median household income for that preceding calendar year, as most recently reported by the Bureau of the Census.
- (4) **GROSS INCOME LIMIT ON PARTIES WITH AN "OWNERSHIP INTEREST"** - Neither the applicant nor the inventor nor a joint inventor has assigned, granted, or conveyed, nor is under an obligation by contract or law to assign, grant, or convey, a license or other ownership interest in the application concerned to an entity that, in the calendar year preceding the calendar year in which the applicable fee is being paid, had a gross income, as defined in section 61(a) of the Internal Revenue Code of 1986, exceeding the "Maximum Qualifying Gross Income" reported on the USPTO website at http://www.uspto.gov/patents/law/micro_entity.jsp which is equal to three times the median household income for that preceding calendar year, as most recently reported by the Bureau of the Census.

SIGNATURE by a party set forth in 37 CFR 1.33(b)

Signature	/ Jacklyn S. Easlick /			
Name	Jacklyn S Easlick			
Date	10/23/2013	Telephone	9176990071	Registration No.



There is more than one inventor and I am one of the inventors who are jointly identified as the applicant. Additional certification form(s) signed by the other joint inventor(s) are included with this form.

Electronic Patent Application Fee Transmittal

Application Number:	29431801			
Filing Date:	11-Sep-2012			
Title of Invention:	HANDBAG HANGER HOOK			
First Named Inventor/Applicant Name:	Jacklyn S. EASLICK			
Filer:	Ming Chow/Vicky Cheng			
Attorney Docket Number:	TP-EASJ-HIA2			
Filed as Micro Entity				
Design Filing Fees				
Description	Fee Code	Quantity	Amount	Sub-Total in USD(\$)
Basic Filing:				
Pages:				
Claims:				
Miscellaneous-Filing:				
Petition:				
Patent-Appeals-and-Interference:				
Post-Allowance-and-Post-Issuance:				
Design Issue Fee	3502	1	255	255
Extension-of-Time:				

Description	Fee Code	Quantity	Amount	Sub-Total in USD(\$)
Miscellaneous:				
Total in USD (\$)				255

Electronic Acknowledgement Receipt

EFS ID:	17208312
Application Number:	29431801
International Application Number:	
Confirmation Number:	3337
Title of Invention:	HANDBAG HANGER HOOK
First Named Inventor/Applicant Name:	Jacklyn S. EASLICK
Customer Number:	62439
Filer:	Ming Chow/Vicky Cheng
Filer Authorized By:	Ming Chow
Attorney Docket Number:	TP-EASJ-HIA2
Receipt Date:	23-OCT-2013
Filing Date:	11-SEP-2012
Time Stamp:	15:50:58
Application Type:	Design

Payment information:

Submitted with Payment	yes
Payment Type	Credit Card
Payment was successfully received in RAM	\$255
RAM confirmation Number	2674
Deposit Account	
Authorized User	

File Listing:

Document Number	Document Description	File Name	File Size(Bytes)/ Message Digest	Multi Part /.zip	Pages (if appl.)
-----------------	----------------------	-----------	----------------------------------	------------------	------------------

1	Issue Fee Payment (PTO-85B)	PTO85b_29431801.pdf	72333	no	2
			086103493ec67860139e8a5e348699b73b96d3ad		
Warnings:					
Information:					
2	Certification of Micro Entity (Gross Income Basis)	PTO15_29431801.pdf	117334	no	1
			3050fd69ad8d39396671c2831605ed460a44b719		
Warnings:					
Information:					
3	Fee Worksheet (SB06)	fee-info.pdf	30006	no	2
			e4eb67b0ad6a5b873879c42904228064d062d087		
Warnings:					
Information:					
Total Files Size (in bytes):				219673	

This Acknowledgement Receipt evidences receipt on the noted date by the USPTO of the indicated documents, characterized by the applicant, and including page counts, where applicable. It serves as evidence of receipt similar to a Post Card, as described in MPEP 503.

New Applications Under 35 U.S.C. 111

If a new application is being filed and the application includes the necessary components for a filing date (see 37 CFR 1.53(b)-(d) and MPEP 506), a Filing Receipt (37 CFR 1.54) will be issued in due course and the date shown on this Acknowledgement Receipt will establish the filing date of the application.

National Stage of an International Application under 35 U.S.C. 371

If a timely submission to enter the national stage of an international application is compliant with the conditions of 35 U.S.C. 371 and other applicable requirements a Form PCT/DO/EO/903 indicating acceptance of the application as a national stage submission under 35 U.S.C. 371 will be issued in addition to the Filing Receipt, in due course.

New International Application Filed with the USPTO as a Receiving Office

If a new international application is being filed and the international application includes the necessary components for an international filing date (see PCT Article 11 and MPEP 1810), a Notification of the International Application Number and of the International Filing Date (Form PCT/RO/105) will be issued in due course, subject to prescriptions concerning national security, and the date shown on this Acknowledgement Receipt will establish the international filing date of the application.

LTJ

PART B - FEE(S) TRANSMITTAL

Complete and send this form, together with applicable fee(s), to: Mail Mail Stop ISSUE FEE
Commissioner for Patents
P.O. Box 1450
Alexandria, Virginia 22313-1450
or Fax (571)-273-2885

INSTRUCTIONS: This form should be used for transmitting the ISSUE FEE and PUBLICATION FEE (if required). Blocks 1 through 5 should be completed where appropriate. All further correspondence including the Patent, advance orders and notification of maintenance fees will be mailed to the current correspondence address as indicated unless corrected below or directed otherwise in Block 1, by (a) specifying a new correspondence address; and/or (b) indicating a separate "FEE ADDRESS" for maintenance fee notifications.

CURRENT CORRESPONDENCE ADDRESS (Note: Use Block 1 for any change of address)

Sinorica, LLC
19785 Crystal Rock Drive
Suite 207
Germantown, MD-20874



Note: A certificate of mailing can only be used for domestic mailings of the Fee(s) Transmittal. This certificate cannot be used for any other accompanying papers. Each additional paper, such as an assignment or formal drawing, must have its own certificate of mailing or transmission.

Certificate of Mailing or Transmission

I hereby certify that this Fee(s) Transmittal is being deposited with the United States Postal Service with sufficient postage for first class mail in an envelope addressed to the Mail Stop ISSUE FEE address above, or being facsimile transmitted to the USPTO (571) 273-2885, on the date indicated below.

Form with fields for Depositor's name, Signature, and Date.

10/24/2013 INTEFSW 00002674 29431801

01 FC:3502 255.00 OP

Table with columns: APPLICATION NO., FILING DATE, FIRST NAMED INVENTOR, ATTORNEY DOCKET NO., CONFIRMATION NO.

TITLE OF INVENTION:

Table with columns: APPLN. TYPE, SMALL ENTITY, ISSUE FEE DUE, PUBLICATION FEE DUE, PREV. PAID ISSUE FEE, TOTAL FEE(S) DUE, DATE DUE. Includes sub-table for EXAMINER, ART UNIT, CLASS-SUBCLASS.

1. Change of correspondence address or indication of "Fee Address" (37 CFR 1.363). 2. For printing on the patent front page, list (1) the names of up to 3 registered patent attorneys or agents OR, alternatively, (2) the name of a single firm (having as a member a registered attorney or agent) and the names of up to 2 registered patent attorneys or agents.

3. ASSIGNEE NAME AND RESIDENCE DATA TO BE PRINTED ON THE PATENT (print or type) PLEASE NOTE: Unless an assignee is identified below, no assignee data will appear on the patent. (A) NAME OF ASSIGNEE (B) RESIDENCE: (CITY and STATE OR COUNTRY)

Please check the appropriate assignee category or categories (will not be printed on the patent): Individual Corporation or other private group entity Government

4a. The following fee(s) are submitted: Issue Fee, Publication Fee, Advance Order. 4b. Payment of Fee(s): A check is enclosed, Payment by credit card, The Director is hereby authorized to charge the required fee(s), any deficiency, or credit any overpayment, to Deposit Account Number.

5. Change in Entity Status (from status indicated above) a. Applicant claims SMALL ENTITY status. See 37 CFR 1.27. b. Applicant is no longer claiming SMALL ENTITY status. See 37 CFR 1.27(g)(2).

NOTE: The Issue Fee and Publication Fee (if required) will not be accepted from anyone other than the applicant; a registered attorney or agent; or the assignee or other party in interest as shown by the records of the United States Patent and Trademark Office.

Authorized Signature /Ming Chow/
Typed or printed name Ming Chow

Date 10-23-2013
Registration No. 58531

This collection of information is required by 37 CFR 1.311. The information is required to obtain or retain a benefit by the public which is to file (and by the USPTO to process) an application. Confidentiality is governed by 35 U.S.C. 122 and 37 CFR 1.14. This collection is estimated to take 12 minutes to complete, including gathering, preparing, and submitting the completed application form to the USPTO. Time will vary depending upon the individual case. Any comments on the amount of time you require to complete this form and/or suggestions for reducing this burden, should be sent to the Chief Information Officer, U.S. Patent and Trademark Office, U.S. Department of Commerce, P.O. Box 1450, Alexandria, Virginia 22313-1450. DO NOT SEND FEES OR COMPLETED FORMS TO THIS ADDRESS. SEND TO: Commissioner for Patents, P.O. Box 1450, Alexandria, Virginia 22313-1450.

Under the Paperwork Reduction Act of 1995, no persons are required to respond to a collection of information unless it displays a valid OMB control number.



Privacy Act Statement

The Privacy Act of 1974 (P.L. 93-579) requires that you be given certain information in connection with your submission of the attached form related to a patent application or patent. Accordingly, pursuant to the requirements of the Act, please be advised that: (1) the general authority for the collection of this information is 35 U.S.C. 2(b)(2); (2) furnishing of the information solicited is voluntary; and (3) the principal purpose for which the information is used by the U.S. Patent and Trademark Office is to process and/or examine your submission related to a patent application or patent. If you do not furnish the requested information, the U.S. Patent and Trademark Office may not be able to process and/or examine your submission, which may result in termination of proceedings or abandonment of the application or expiration of the patent.

The information provided by you in this form will be subject to the following routine uses:

1. The information on this form will be treated confidentially to the extent allowed under the Freedom of Information Act (5 U.S.C. 552) and the Privacy Act (5 U.S.C. 552a). Records from this system of records may be disclosed to the Department of Justice to determine whether disclosure of these records is required by the Freedom of Information Act.
2. A record from this system of records may be disclosed, as a routine use, in the course of presenting evidence to a court, magistrate, or administrative tribunal, including disclosures to opposing counsel in the course of settlement negotiations.
3. A record in this system of records may be disclosed, as a routine use, to a Member of Congress submitting a request involving an individual, to whom the record pertains, when the individual has requested assistance from the Member with respect to the subject matter of the record.
4. A record in this system of records may be disclosed, as a routine use, to a contractor of the Agency having need for the information in order to perform a contract. Recipients of information shall be required to comply with the requirements of the Privacy Act of 1974, as amended, pursuant to 5 U.S.C. 552a(m).
5. A record related to an International Application filed under the Patent Cooperation Treaty in this system of records may be disclosed, as a routine use, to the International Bureau of the World Intellectual Property Organization, pursuant to the Patent Cooperation Treaty.
6. A record in this system of records may be disclosed, as a routine use, to another federal agency for purposes of National Security review (35 U.S.C. 181) and for review pursuant to the Atomic Energy Act (42 U.S.C. 218(c)).
7. A record from this system of records may be disclosed, as a routine use, to the Administrator, General Services, or his/her designee, during an inspection of records conducted by GSA as part of that agency's responsibility to recommend improvements in records management practices and programs, under authority of 44 U.S.C. 2904 and 2906. Such disclosure shall be made in accordance with the GSA regulations governing inspection of records for this purpose, and any other relevant (i.e., GSA or Commerce) directive. Such disclosure shall not be used to make determinations about individuals.
8. A record from this system of records may be disclosed, as a routine use, to the public after either publication of the application pursuant to 35 U.S.C. 122(b) or issuance of a patent pursuant to 35 U.S.C. 151. Further, a record may be disclosed, subject to the limitations of 37 CFR 1.14, as a routine use, to the public if the record was filed in an application which became abandoned or in which the proceedings were terminated and which application is referenced by either a published application, an application open to public inspection or an issued patent.
9. A record from this system of records may be disclosed, as a routine use, to a Federal, State, or local law enforcement agency, if the USPTO becomes aware of a violation or potential violation of law or regulation.

UNITED STATES PATENT AND TRADEMARK OFFICE
COMMISSIONER FOR PATENTS
P.O.BOX 1450
ALEXANDRIA VA 22313-1451

PRESORTED
FIRST-CLASS MAIL
U.S. POSTAGE PAID
POSTEDIGITAL
NNNNN

SINORICA, LLC
19785 Crystal Rock Drive
Suite 207
Germantown, MD 20874

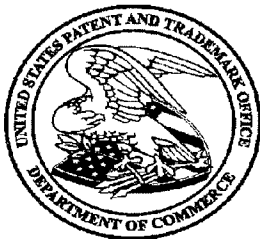

**Courtesy Reminder for
Application Serial No: 29/431,801**

Attorney Docket No: TP-EASJ-HIA2

Customer Number: 62439

Date of Electronic Notification: 10/11/2013

This is a courtesy reminder that new correspondence is available for this application. If you have not done so already, please review the correspondence. The official date of notification of the outgoing correspondence will be indicated on the form PTOL-90 accompanying the correspondence.

An email notification regarding the correspondence was sent to the following email address(es) associated with your customer number:

MCHOW@SINORICA.COM
DOMINS@COMCAST.NET
SINORICA@GMAIL.COM

To view your correspondence online or update your email addresses, please visit us anytime at <https://sportal.uspto.gov/secure/myportal/privatepair>. If you have any questions, please email the Electronic Business Center (EBC) at EBC@uspto.gov or call 1-866-217-9197.



UNITED STATES DEPARTMENT OF COMMERCE
United States Patent and Trademark Office
Address: COMMISSIONER FOR PATENTS
P.O. Box 1450
Alexandria, Virginia 22313-1450
www.uspto.gov

NOTICE OF ALLOWANCE AND FEE(S) DUE

62439 7590 10/11/2013
SINORICA, LLC
19785 Crystal Rock Drive
Suite 207
Germantown, MD 20874

EXAMINER

BAYNHAM, HOLLY H

ART UNIT PAPER NUMBER

2915

DATE MAILED: 10/11/2013

Table with 5 columns: APPLICATION NO., FILING DATE, FIRST NAMED INVENTOR, ATTORNEY DOCKET NO., CONFIRMATION NO.

29/431,801 09/11/2012 Jacklyn S. EASLICK TP-EASJ-HIA2 3337

TITLE OF INVENTION: HANDBAG HANGER HOOK

Table with 7 columns: APPLN. TYPE, ENTITY STATUS, ISSUE FEE DUE, PUBLICATION FEE DUE, PREV. PAID ISSUE FEE, TOTAL FEE(S) DUE, DATE DUE

nonprovisional SMALL \$510 \$0 \$0 \$510 01/13/2014

THE APPLICATION IDENTIFIED ABOVE HAS BEEN EXAMINED AND IS ALLOWED FOR ISSUANCE AS A PATENT. PROSECUTION ON THE MERITS IS CLOSED. THIS NOTICE OF ALLOWANCE IS NOT A GRANT OF PATENT RIGHTS. THIS APPLICATION IS SUBJECT TO WITHDRAWAL FROM ISSUE AT THE INITIATIVE OF THE OFFICE OR UPON PETITION BY THE APPLICANT. SEE 37 CFR 1.313 AND MPEP 1308.

THE ISSUE FEE AND PUBLICATION FEE (IF REQUIRED) MUST BE PAID WITHIN THREE MONTHS FROM THE MAILING DATE OF THIS NOTICE OR THIS APPLICATION SHALL BE REGARDED AS ABANDONED. THIS STATUTORY PERIOD CANNOT BE EXTENDED. SEE 35 U.S.C. 151. THE ISSUE FEE DUE INDICATED ABOVE DOES NOT REFLECT A CREDIT FOR ANY PREVIOUSLY PAID ISSUE FEE IN THIS APPLICATION. IF AN ISSUE FEE HAS PREVIOUSLY BEEN PAID IN THIS APPLICATION (AS SHOWN ABOVE), THE RETURN OF PART B OF THIS FORM WILL BE CONSIDERED A REQUEST TO REAPPLY THE PREVIOUSLY PAID ISSUE FEE TOWARD THE ISSUE FEE NOW DUE.

HOW TO REPLY TO THIS NOTICE:

I. Review the ENTITY STATUS shown above. If the ENTITY STATUS is shown as SMALL or MICRO, verify whether entitlement to that entity status still applies.

If the ENTITY STATUS is the same as shown above, pay the TOTAL FEE(S) DUE shown above.

If the ENTITY STATUS is changed from that shown above, on PART B - FEE(S) TRANSMITTAL, complete section number 5 titled "Change in Entity Status (from status indicated above)".

For purposes of this notice, small entity fees are 1/2 the amount of undiscounted fees, and micro entity fees are 1/2 the amount of small entity fees.

II. PART B - FEE(S) TRANSMITTAL, or its equivalent, must be completed and returned to the United States Patent and Trademark Office (USPTO) with your ISSUE FEE and PUBLICATION FEE (if required). If you are charging the fee(s) to your deposit account, section "4b" of Part B - Fee(s) Transmittal should be completed and an extra copy of the form should be submitted. If an equivalent of Part B is filed, a request to reapply a previously paid issue fee must be clearly made, and delays in processing may occur due to the difficulty in recognizing the paper as an equivalent of Part B.

III. All communications regarding this application must give the application number. Please direct all communications prior to issuance to Mail Stop ISSUE FEE unless advised to the contrary.

IMPORTANT REMINDER: Utility patents issuing on applications filed on or after Dec. 12, 1980 may require payment of maintenance fees. It is patentee's responsibility to ensure timely payment of maintenance fees when due.

PART B - FEE(S) TRANSMITTAL

**Complete and send this form, together with applicable fee(s), to: Mail Mail Stop ISSUE FEE
 Commissioner for Patents
 P.O. Box 1450
 Alexandria, Virginia 22313-1450
 or Fax (571)-273-2885**

INSTRUCTIONS: This form should be used for transmitting the ISSUE FEE and PUBLICATION FEE (if required). Blocks 1 through 5 should be completed where appropriate. All further correspondence including the Patent, advance orders and notification of maintenance fees will be mailed to the current correspondence address as indicated unless corrected below or directed otherwise in Block 1, by (a) specifying a new correspondence address; and/or (b) indicating a separate "FEE ADDRESS" for maintenance fee notifications.

CURRENT CORRESPONDENCE ADDRESS (Note: Use Block 1 for any change of address)

62439 7590 10/11/2013
SINORICA, LLC
 19785 Crystal Rock Drive
 Suite 207
 Germantown, MD 20874

Note: A certificate of mailing can only be used for domestic mailings of the Fee(s) Transmittal. This certificate cannot be used for any other accompanying papers. Each additional paper, such as an assignment or formal drawing, must have its own certificate of mailing or transmission.

Certificate of Mailing or Transmission

I hereby certify that this Fee(s) Transmittal is being deposited with the United States Postal Service with sufficient postage for first class mail in an envelope addressed to the Mail Stop ISSUE FEE address above, or being facsimile transmitted to the USPTO (571) 273-2885, on the date indicated below.

(Depositor's name)
(Signature)
(Date)

APPLICATION NO.	FILING DATE	FIRST NAMED INVENTOR	ATTORNEY DOCKET NO.	CONFIRMATION NO.
29/431,801	09/11/2012	Jacklyn S. EASLICK	TP-EASJ-HIA2	3337

TITLE OF INVENTION: HANDBAG HANGER HOOK

APPLN. TYPE	ENTITY STATUS	ISSUE FEE DUE	PUBLICATION FEE DUE	PREV. PAID ISSUE FEE	TOTAL FEE(S) DUE	DATE DUE
nonprovisional	SMALL	\$510	\$0	\$0	\$510	01/13/2014

EXAMINER	ART UNIT	CLASS-SUBCLASS
BAYNHAM, HOLLY H	2915	D08-367000

<p>1. Change of correspondence address or indication of "Fee Address" (37 CFR 1.363).</p> <p><input type="checkbox"/> Change of correspondence address (or Change of Correspondence Address form PTO/SB/122) attached.</p> <p><input type="checkbox"/> "Fee Address" indication (or "Fee Address" Indication form PTO/SB/47; Rev 03-02 or more recent) attached. Use of a Customer Number is required.</p>	<p>2. For printing on the patent front page, list</p> <p>(1) the names of up to 3 registered patent attorneys or agents OR, alternatively,</p> <p>(2) the name of a single firm (having as a member a registered attorney or agent) and the names of up to 2 registered patent attorneys or agents. If no name is listed, no name will be printed.</p> <p>1 _____</p> <p>2 _____</p> <p>3 _____</p>
---	---

3. ASSIGNEE NAME AND RESIDENCE DATA TO BE PRINTED ON THE PATENT (print or type)

PLEASE NOTE: Unless an assignee is identified below, no assignee data will appear on the patent. If an assignee is identified below, the document has been filed for recordation as set forth in 37 CFR 3.11. Completion of this form is NOT a substitute for filing an assignment.

(A) NAME OF ASSIGNEE _____ (B) RESIDENCE: (CITY and STATE OR COUNTRY) _____

Please check the appropriate assignee category or categories (will not be printed on the patent) : Individual Corporation or other private group entity Government

4a. The following fee(s) are submitted:

- Issue Fee
- Publication Fee (No small entity discount permitted)
- Advance Order - # of Copies _____

4b. Payment of Fee(s): (Please first reapply any previously paid issue fee shown above)

- A check is enclosed.
- Payment by credit card. Form PTO-2038 is attached.
- The Director is hereby authorized to charge the required fee(s), any deficiency, or credit any overpayment, to Deposit Account Number _____ (enclose an extra copy of this form).

5. **Change in Entity Status** (from status indicated above)

- Applicant certifying micro entity status. See 37 CFR 1.29
- Applicant asserting small entity status. See 37 CFR 1.27
- Applicant changing to regular undiscounted fee status.

NOTE: Absent a valid certification of Micro Entity Status (see form PTO/SB/15A and 15B), issue fee payment in the micro entity amount will not be accepted at the risk of application abandonment.

NOTE: If the application was previously under micro entity status, checking this box will be taken to be a notification of loss of entitlement to micro entity status.

NOTE: Checking this box will be taken to be a notification of loss of entitlement to small or micro entity status, as applicable.

NOTE: The Issue Fee and Publication Fee (if required) will not be accepted from anyone other than the applicant; a registered attorney or agent; or the assignee or other party in interest as shown by the records of the United States Patent and Trademark Office.

Authorized Signature _____

Date _____

Typed or printed name _____

Registration No. _____

This collection of information is required by 37 CFR 1.311. The information is required to obtain or retain a benefit by the public which is to file (and by the USPTO to process) an application. Confidentiality is governed by 35 U.S.C. 122 and 37 CFR 1.14. This collection is estimated to take 12 minutes to complete, including gathering, preparing, and submitting the completed application form to the USPTO. Time will vary depending upon the individual case. Any comments on the amount of time you require to complete this form and/or suggestions for reducing this burden, should be sent to the Chief Information Officer, U.S. Patent and Trademark Office, U.S. Department of Commerce, P.O. Box 1450, Alexandria, Virginia 22313-1450. DO NOT SEND FEES OR COMPLETED FORMS TO THIS ADDRESS. SEND TO: Commissioner for Patents, P.O. Box 1450, Alexandria, Virginia 22313-1450.

Under the Paperwork Reduction Act of 1995, no persons are required to respond to a collection of information unless it displays a valid OMB control number.



UNITED STATES PATENT AND TRADEMARK OFFICE

UNITED STATES DEPARTMENT OF COMMERCE
United States Patent and Trademark Office
Address: COMMISSIONER FOR PATENTS
P.O. Box 1450
Alexandria, Virginia 22313-1450
www.uspto.gov

Table with 5 columns: APPLICATION NO., FILING DATE, FIRST NAMED INVENTOR, ATTORNEY DOCKET NO., CONFIRMATION NO.
29/431,801 09/11/2012 Jacklyn S. EASLICK TP-EASJ-HIA2 3337

62439 7590 10/11/2013
SINORICA, LLC
19785 Crystal Rock Drive
Suite 207
Germantown, MD 20874

EXAMINER

BAYNHAM, HOLLY H

ART UNIT PAPER NUMBER

2915

DATE MAILED: 10/11/2013

Determination of Patent Term Extension or Adjustment under 35 U.S.C. 154 (b)

Design patents have a term measured from the issue date of the patent and the term remains the same length regardless of the time that the application for the design patent was pending. Since the above-identified application is an application for a design patent, the patent is not eligible for Patent Term Extension or Adjustment under 35 U.S.C. 154(b).

Any questions regarding the Patent Term Extension or Adjustment determination should be directed to the Office of Patent Legal Administration at (571)-272-7702. Questions relating to issue and publication fee payments should be directed to the Customer Service Center of the Office of Patent Publication at 1-(888)-786-0101 or (571)-272-4200.

Privacy Act Statement

The Privacy Act of 1974 (P.L. 93-579) requires that you be given certain information in connection with your submission of the attached form related to a patent application or patent. Accordingly, pursuant to the requirements of the Act, please be advised that: (1) the general authority for the collection of this information is 35 U.S.C. 2(b)(2); (2) furnishing of the information solicited is voluntary; and (3) the principal purpose for which the information is used by the U.S. Patent and Trademark Office is to process and/or examine your submission related to a patent application or patent. If you do not furnish the requested information, the U.S. Patent and Trademark Office may not be able to process and/or examine your submission, which may result in termination of proceedings or abandonment of the application or expiration of the patent.

The information provided by you in this form will be subject to the following routine uses:

1. The information on this form will be treated confidentially to the extent allowed under the Freedom of Information Act (5 U.S.C. 552) and the Privacy Act (5 U.S.C. 552a). Records from this system of records may be disclosed to the Department of Justice to determine whether disclosure of these records is required by the Freedom of Information Act.
2. A record from this system of records may be disclosed, as a routine use, in the course of presenting evidence to a court, magistrate, or administrative tribunal, including disclosures to opposing counsel in the course of settlement negotiations.
3. A record in this system of records may be disclosed, as a routine use, to a Member of Congress submitting a request involving an individual, to whom the record pertains, when the individual has requested assistance from the Member with respect to the subject matter of the record.
4. A record in this system of records may be disclosed, as a routine use, to a contractor of the Agency having need for the information in order to perform a contract. Recipients of information shall be required to comply with the requirements of the Privacy Act of 1974, as amended, pursuant to 5 U.S.C. 552a(m).
5. A record related to an International Application filed under the Patent Cooperation Treaty in this system of records may be disclosed, as a routine use, to the International Bureau of the World Intellectual Property Organization, pursuant to the Patent Cooperation Treaty.
6. A record in this system of records may be disclosed, as a routine use, to another federal agency for purposes of National Security review (35 U.S.C. 181) and for review pursuant to the Atomic Energy Act (42 U.S.C. 218(c)).
7. A record from this system of records may be disclosed, as a routine use, to the Administrator, General Services, or his/her designee, during an inspection of records conducted by GSA as part of that agency's responsibility to recommend improvements in records management practices and programs, under authority of 44 U.S.C. 2904 and 2906. Such disclosure shall be made in accordance with the GSA regulations governing inspection of records for this purpose, and any other relevant (i.e., GSA or Commerce) directive. Such disclosure shall not be used to make determinations about individuals.
8. A record from this system of records may be disclosed, as a routine use, to the public after either publication of the application pursuant to 35 U.S.C. 122(b) or issuance of a patent pursuant to 35 U.S.C. 151. Further, a record may be disclosed, subject to the limitations of 37 CFR 1.14, as a routine use, to the public if the record was filed in an application which became abandoned or in which the proceedings were terminated and which application is referenced by either a published application, an application open to public inspection or an issued patent.
9. A record from this system of records may be disclosed, as a routine use, to a Federal, State, or local law enforcement agency, if the USPTO becomes aware of a violation or potential violation of law or regulation.

**Notices of Allowance and Fee(s) Due mailed between October 1, 2013 and
December 31, 2013**

(Addendum to PTOL-85)

If the “Notice of Allowance and Fee(s) Due” has a mailing date on or after October 1, 2013 and before January 1, 2014, the following information is applicable to this application.

If the issue fee is being timely paid on or after January 1, 2014, the amount due is the issue fee and publication fee in effect January 1, 2014. On January 1, 2014, the issue fees set forth in 37 CFR 1.18 decrease significantly and the publication fee set forth in 37 CFR 1.18(d)(1) decreases to \$0.

If an issue fee or publication fee has been previously paid in this application, applicant is not entitled to a refund of the difference between the amount paid and the amount in effect on January 1, 2014.

Notice of Allowability For A Design Application	Application No. 29/431,801	Applicant(s) EASLICK, JACKLYN S.	
	Examiner HOLLY BAYNHAM	Art Unit 2915	AIA (First Inventor to File) Status No

-- The MAILING DATE of this communication appears on the cover sheet with the correspondence address--

All claims being allowable, PROSECUTION ON THE MERITS IS (OR REMAINS) CLOSED in this application. If not included herewith (or previously mailed), a Notice of Allowance (PTOL-85) or other appropriate communication will be mailed in due course. **THIS NOTICE OF ALLOWABILITY IS NOT A GRANT OF PATENT RIGHTS.** This application is subject to withdrawal from issue at the initiative of the Office or upon petition by the applicant. See 37 CFR 1.313 and MPEP 1308.

1. This communication is responsive to _____.
 A declaration(s)/affidavit(s) under **37 CFR 1.130(b)** was/were filed on _____.
2. An election was made by the applicant in response to a restriction requirement set forth during the interview on _____; the restriction requirement and election have been incorporated into this action.
3. The claim is allowed.
4. Acceptable drawings:
 - (a) The drawings filed on 11 September 2012 are accepted by the Examiner.
 - (b) Drawing Figures filed on _____ and drawing Figures filed on _____ are accepted by the Examiner.
5. The claim for foreign priority under 35 U.S.C. § 119(a)-(d) or (f) is acknowledged.

Certified copies:

- a) All b) Some *c) None of the:
 1. Certified copies of the priority documents have been received.
 2. Certified copies of the priority documents have been received in Application No. _____.
 3. Copies of the certified copies of the priority documents have been received in this national stage application from the International Bureau (PCT Rule 17.2(a)).
- * Certified copies not received: _____.

Applicant has THREE MONTHS FROM THE "MAILING DATE" of this communication to file a reply complying with the requirements noted below. Failure to timely comply will result in ABANDONMENT of this application.
THIS THREE-MONTH PERIOD IS NOT EXTENDABLE.

6. CORRECTED DRAWINGS (as "replacement sheets") must be submitted.
 - including changes required by the attached Examiner's Amendment / Comment or in the Office action of Paper No./Mail Date _____.

Identifying indicia such as the application number (see 37 CFR 1.84(c)) should be written on the drawings in the front (not the back) of each sheet. Replacement sheet(s) should be labeled as such in the header according to 37 CFR 1.121(d).

Attachment(s)

- | | |
|--|---|
| 1. <input checked="" type="checkbox"/> Notice of References Cited (PTO-892) | 4. <input checked="" type="checkbox"/> Examiner's Amendment/Comment |
| 2. <input type="checkbox"/> Information Disclosure Statements (PTO/SB/08),
Paper No./Receipt Date _____ | 5. <input type="checkbox"/> Examiner's Statement of Reasons for Allowance |
| 3. <input type="checkbox"/> Interview Summary (PTO-413),
Paper No./Mail Date _____ | 6. <input type="checkbox"/> Other _____. |

NOTE:

Art Unit: 2915

The present application is being examined under the pre-AIA first to invent provisions.

Examiner's Amendment

1. An examiner's amendment to the record appears below. Should the changes and/or additions be unacceptable to applicant, an amendment may be filed as provided by 37 CFR 1.312. To ensure consideration of such an amendment, it MUST be submitted no later than the payment of the issue fee.

Specification

Figure description- For accuracy, "reduced scale" has been inserted in the figure description of Fig. 8 before "perspective".

Contact Information

To inquire about this communication or earlier communications, contact Holly H. Baynham by phone at (571) 272-2597. The examiner can normally be reached on Mondays through Fridays from 7:30am to 4:00pm. If attempts to reach the examiner by phone are unsuccessful, the applicant can reach the examiner's supervisor, Rob Spear, by phone at (571) 272-2645. The official fax number is 571-273-8300. To ask a question of a general nature or about the status of this application, contact 2900 Customer Service by phone at 703-306-5648.

Information regarding the status of an application may be obtained from the Patent Application Information Retrieval (PAIR) system. Status information for published applications may be obtained from either Private PAIR or Public PAIR. Status information for unpublished applications is available through Private PAIR only.

Application/Control Number: 29/431,801

Page 3

Art Unit: 2915

For more information about the PAIR system, see <http://pair-direct.uspto.gov>.

Should you have questions on access to the Private PAIR system, contact the

Electronic Business Center (EBC) at 866-217-9197 (toll-free).

/Holly H. Baynham/
Primary Examiner, Art Unit 2915

Notice of References Cited	Application/Control No. 29/431,801	Applicant(s)/Patent Under Reexamination EASLICK, JACKLYN S.	
	Examiner HOLLY BAYNHAM	Art Unit 2915	Page 1 of 1

U.S. PATENT DOCUMENTS

*	Document Number Country Code-Number-Kind Code	Date MM-YYYY	Name	Classification
*	A US-5,575,446 A	11-1996	Swenson et al.	248/304
*	B US-D475,278 S	06-2003	Williams, Arnold H.	D8/367
*	C US-D493,092 S	07-2004	Kalat, Edward W.	D8/367
*	D US-D560,924 S	02-2008	Walker, David Lamont	D6/396
*	E US-D644,438 S	09-2011	Brucker, Lester A.	D3/328
*	F US-			
*	G US-			
*	H US-			
*	I US-			
*	J US-			
*	K US-			
*	L US-			
*	M US-			

FOREIGN PATENT DOCUMENTS

*	Document Number Country Code-Number-Kind Code	Date MM-YYYY	Country	Name	Classification
*	N				
*	O				
*	P				
*	Q				
*	R				
*	S				
*	T				

NON-PATENT DOCUMENTS

*	Document Number Country Code-Number-Kind Code	Date MM-YYYY	Country	Name	Classification
*	Include as applicable: Author, Title Date, Publisher, Edition or Volume, Pertinent Pages)				
*	U				
*	V				
*	W				
*	X				

*A copy of this reference is not being furnished with this Office action. (See MPEP § 707.05(a).)
Dates in MM-YYYY format are publication dates. Classifications may be US or foreign.

Search Notes 	Application/Control No. 29431801	Applicant(s)/Patent Under Reexamination EASLICK, JACKLYN S.
	Examiner HOLLY BAYNHAM	Art Unit 2915

CPC- SEARCHED		
Symbol	Date	Examiner

CPC COMBINATION SETS - SEARCHED		
Symbol	Date	Examiner

US CLASSIFICATION SEARCHED			
Class	Subclass	Date	Examiner
d3	328	10/2/2013	hb
d8	367		
248	302-303		

SEARCH NOTES		
Search Notes	Date	Examiner
inventor name search	10/2/2013	hb
EAST search		

INTERFERENCE SEARCH			
US Class/ CPC Symbol	US Subclass / CPC Group	Date	Examiner
d3	328	10/2/2013	hb
d8	367		

	/HOLLY BAYNHAM/ Primary Examiner.Art Unit 2915
--	---

UNITED STATES PATENT AND TRADEMARK OFFICE

UNITED STATES DEPARTMENT OF COMMERCE
 United States Patent and Trademark Office
 Address: COMMISSIONER FOR PATENTS
 P. O. Box 1450
 Alexandria, Virginia 22313-1450
 www.uspto.gov

BIB DATA SHEET
CONFIRMATION NO. 3337

SERIAL NUMBER	FILING or 371(c) DATE RULE	CLASS	GROUP ART UNIT	ATTORNEY DOCKET NO. TP-EASJ-HIA2	
29/431,801	09/11/2012	D08	2915		
APPLICANTS Jacklyn S. EASLICK, Rye, NY; ** CONTINUING DATA ***** ** FOREIGN APPLICATIONS ***** ** IF REQUIRED, FOREIGN FILING LICENSE GRANTED ** ** SMALL ENTITY ** 09/18/2012					
Foreign Priority claimed <input type="checkbox"/> Yes <input checked="" type="checkbox"/> No 35 USC 119(a-d) conditions met <input type="checkbox"/> Yes <input type="checkbox"/> No Verified and Acknowledged <u>/HOLLY H BAYNHAM/</u> <small>Examiner's Signature</small>	<input type="checkbox"/> Met after Allowance <small>Initials</small>	STATE OR COUNTRY NY	SHEETS DRAWINGS 8	TOTAL CLAIMS 1	INDEPENDENT CLAIMS 1
ADDRESS SINORICA, LLC 19785 Crystal Rock Drive Suite 207 Germantown, MD 20874 UNITED STATES					
TITLE Handbag Hanger Hook					
FILING FEE RECEIVED 265	FEES: Authority has been given in Paper No. _____ to charge/credit DEPOSIT ACCOUNT No. _____ for following:		<input type="checkbox"/> All Fees <input type="checkbox"/> 1.16 Fees (Filing) <input type="checkbox"/> 1.17 Fees (Processing Ext. of time) <input type="checkbox"/> 1.18 Fees (Issue) <input type="checkbox"/> Other _____ <input type="checkbox"/> Credit		



UNITED STATES PATENT AND TRADEMARK OFFICE

UNITED STATES DEPARTMENT OF COMMERCE
United States Patent and Trademark Office
Address: COMMISSIONER FOR PATENTS
P.O. Box 1450
Alexandria, Virginia 22313-1450
www.uspto.gov

Table with 7 columns: APPLICATION NUMBER, FILING or 371(c) DATE, GRP ART UNIT, FIL FEE REC'D, ATTY. DOCKET NO, TOT CLAIMS, IND CLAIMS. Row 1: 29/431,801, 09/11/2012, 2913, 265, TP-EASJ-HIA2, 1, 1

CONFIRMATION NO. 3337

FILING RECEIPT



62439
SINORICA, LLC
19785 Crystal Rock Drive
Suite 207
Germantown, MD 20874

Date Mailed: 09/21/2012

Receipt is acknowledged of this non-provisional patent application. The application will be taken up for examination in due course. Applicant will be notified as to the results of the examination. Any correspondence concerning the application must include the following identification information: the U.S. APPLICATION NUMBER, FILING DATE, NAME OF APPLICANT, and TITLE OF INVENTION. Fees transmitted by check or draft are subject to collection. Please verify the accuracy of the data presented on this receipt. If an error is noted on this Filing Receipt, please submit a written request for a Filing Receipt Correction. Please provide a copy of this Filing Receipt with the changes noted thereon. If you received a "Notice to File Missing Parts" for this application, please submit any corrections to this Filing Receipt with your reply to the Notice. When the USPTO processes the reply to the Notice, the USPTO will generate another Filing Receipt incorporating the requested corrections

Inventor(s)

Jacklyn S. EASLICK, Rye, NY;

Applicant(s)

Jacklyn S. EASLICK, Rye, NY;

Power of Attorney: The patent practitioners associated with Customer Number 062439

Domestic Priority data as claimed by applicant

Foreign Applications (You may be eligible to benefit from the Patent Prosecution Highway program at the USPTO. Please see http://www.uspto.gov for more information.)

If Required, Foreign Filing License Granted: 09/18/2012

The country code and number of your priority application, to be used for filing abroad under the Paris Convention, is US 29/431,801

Projected Publication Date: None, application is not eligible for pre-grant publication

Non-Publication Request: No

Early Publication Request: No

** SMALL ENTITY **

Title

Handbag Hanger Hook

Preliminary Class

D08

PROTECTING YOUR INVENTION OUTSIDE THE UNITED STATES

Since the rights granted by a U.S. patent extend only throughout the territory of the United States and have no effect in a foreign country, an inventor who wishes patent protection in another country must apply for a patent in a specific country or in regional patent offices. Applicants may wish to consider the filing of an international application under the Patent Cooperation Treaty (PCT). An international (PCT) application generally has the same effect as a regular national patent application in each PCT-member country. The PCT process **simplifies** the filing of patent applications on the same invention in member countries, but **does not result** in a grant of "an international patent" and does not eliminate the need of applicants to file additional documents and fees in countries where patent protection is desired.

Almost every country has its own patent law, and a person desiring a patent in a particular country must make an application for patent in that country in accordance with its particular laws. Since the laws of many countries differ in various respects from the patent law of the United States, applicants are advised to seek guidance from specific foreign countries to ensure that patent rights are not lost prematurely.

Applicants also are advised that in the case of inventions made in the United States, the Director of the USPTO must issue a license before applicants can apply for a patent in a foreign country. The filing of a U.S. patent application serves as a request for a foreign filing license. The application's filing receipt contains further information and guidance as to the status of applicant's license for foreign filing.

Applicants may wish to consult the USPTO booklet, "General Information Concerning Patents" (specifically, the section entitled "Treaties and Foreign Patents") for more information on timeframes and deadlines for filing foreign patent applications. The guide is available either by contacting the USPTO Contact Center at 800-786-9199, or it can be viewed on the USPTO website at <http://www.uspto.gov/web/offices/pac/doc/general/index.html>.

For information on preventing theft of your intellectual property (patents, trademarks and copyrights), you may wish to consult the U.S. Government website, <http://www.stopfakes.gov>. Part of a Department of Commerce initiative, this website includes self-help "toolkits" giving innovators guidance on how to protect intellectual property in specific countries such as China, Korea and Mexico. For questions regarding patent enforcement issues, applicants may call the U.S. Government hotline at 1-866-999-HALT (1-866-999-4158).

LICENSE FOR FOREIGN FILING UNDER
Title 35, United States Code, Section 184
Title 37, Code of Federal Regulations, 5.11 & 5.15

GRANTED

The applicant has been granted a license under 35 U.S.C. 184, if the phrase "IF REQUIRED, FOREIGN FILING LICENSE GRANTED" followed by a date appears on this form. Such licenses are issued in all applications where the conditions for issuance of a license have been met, regardless of whether or not a license may be required as

set forth in 37 CFR 5.15. The scope and limitations of this license are set forth in 37 CFR 5.15(a) unless an earlier license has been issued under 37 CFR 5.15(b). The license is subject to revocation upon written notification. The date indicated is the effective date of the license, unless an earlier license of similar scope has been granted under 37 CFR 5.13 or 5.14.

This license is to be retained by the licensee and may be used at any time on or after the effective date thereof unless it is revoked. This license is automatically transferred to any related applications(s) filed under 37 CFR 1.53(d). This license is not retroactive.

The grant of a license does not in any way lessen the responsibility of a licensee for the security of the subject matter as imposed by any Government contract or the provisions of existing laws relating to espionage and the national security or the export of technical data. Licensees should apprise themselves of current regulations especially with respect to certain countries, of other agencies, particularly the Office of Defense Trade Controls, Department of State (with respect to Arms, Munitions and Implements of War (22 CFR 121-128)); the Bureau of Industry and Security, Department of Commerce (15 CFR parts 730-774); the Office of Foreign Assets Control, Department of Treasury (31 CFR Parts 500+) and the Department of Energy.

NOT GRANTED

No license under 35 U.S.C. 184 has been granted at this time, if the phrase "IF REQUIRED, FOREIGN FILING LICENSE GRANTED" DOES NOT appear on this form. Applicant may still petition for a license under 37 CFR 5.12, if a license is desired before the expiration of 6 months from the filing date of the application. If 6 months has lapsed from the filing date of this application and the licensee has not received any indication of a secrecy order under 35 U.S.C. 181, the licensee may foreign file the application pursuant to 37 CFR 5.15(b).

SelectUSA

The United States represents the largest, most dynamic marketplace in the world and is an unparalleled location for business investment, innovation and commercialization of new technologies. The USA offers tremendous resources and advantages for those who invest and manufacture goods here. Through SelectUSA, our nation works to encourage, facilitate, and accelerate business investment. To learn more about why the USA is the best country in the world to develop technology, manufacture products, and grow your business, visit SelectUSA.gov.



UNITED STATES PATENT AND TRADEMARK OFFICE

UNITED STATES DEPARTMENT OF COMMERCE
United States Patent and Trademark Office
Address: COMMISSIONER FOR PATENTS
P.O. Box 1450
Alexandria, Virginia 22313-1450
www.uspto.gov

APPLICATION NUMBER	FILING OR 371(C) DATE	FIRST NAMED APPLICANT	ATTY. DOCKET NO./TITLE
29/431,801	09/11/2012	Jacklyn S. EASLICK	TP-EASJ-HIA2

CONFIRMATION NO. 3337

POA ACCEPTANCE LETTER

62439
SINORICA, LLC
19785 Crystal Rock Drive
Suite 207
Germantown, MD 20874



Date Mailed: 09/21/2012

NOTICE OF ACCEPTANCE OF POWER OF ATTORNEY

This is in response to the Power of Attorney filed 09/11/2012.

The Power of Attorney in this application is accepted. Correspondence in this application will be mailed to the above address as provided by 37 CFR 1.33.

/ttu/

Office of Data Management, Application Assistance Unit (571) 272-4000, or (571) 272-4200, or 1-888-786-0101

Under the Paperwork Reduction Act of 1995, no persons are required to respond to a collection of information unless it displays a valid OMB control number.

PATENT - POWER OF ATTORNEY OR REVOCATION OF POWER OF ATTORNEY WITH A NEW POWER OF ATTORNEY AND CHANGE OF CORRESPONDENCE ADDRESS	Patent Number	
	Issue Date	
	First Named Inventor	Jacklyn S Easlick
	Title	Handbag Hanger Hook
	Attorney Docket Number	TP-EASJ-HIA2

I hereby revoke all previous powers of attorney given in the above-identified patent.

A Power of Attorney is submitted herewith.

OR

I hereby appoint Practitioner(s) associated with the following Customer Number as my/our attorney(s) or agent(s) with respect to the patent identified above, and to transact all business in the United States Patent and Trademark Office connected therewith: 062439

OR

I hereby appoint Practitioner(s) named below as my/our attorney(s) or agent(s) with respect to the patent identified above, and to transact all business in the United States Patent and Trademark Office connected therewith:

Practitioner(s) Name	Registration Number

Please recognize or change the correspondence address for the above-identified patent to:

The address associated with the above-mentioned Customer Number.

OR

The address associated with Customer Number:

OR

<input type="checkbox"/> Firm or Individual Name			
Address			
City	State	Zip	
Country			
Telephone	Email		

I am the:

Inventor, having ownership of the patent.

OR

Patent owner.
 Statement under 37 CFR 3.73(b) (Form PTO/SB/96) submitted herewith or filed on _____.

SIGNATURE of Inventor or Patent Owner

Signature	/Jacklyn S. Easlick/	Date	7/25/2012
Name	Jacklyn S Easlick	Telephone	
Title and Company			

NOTE: Signatures of all the inventors or patent owners of the entire interest or their representative(s) are required. Submit multiple forms if more than one signature is required, see below*.

*Total of 1 forms are submitted.

This collection of information is required by 37 CFR 1.31, 1.32 and 1.33. The information is required to obtain or retain a benefit by the public which is to file (and by the USPTO to process) an application. Confidentiality is governed by 35 U.S.C. 122 and 37 CFR 1.11 and 1.14. This collection is estimated to take 3 minutes to complete, including gathering, preparing, and submitting the completed application form to the USPTO. Time will vary depending upon the individual case. Any comments on the amount of time you require to complete this form and/or suggestions for reducing this burden, should be sent to the Chief Information Officer, U.S. Patent and Trademark Office, U.S. Department of Commerce, P.O. Box 1450, Alexandria, VA 22313-1450. DO NOT SEND FEES OR COMPLETED FORMS TO THIS ADDRESS. **SEND TO: Commissioner for Patents, P.O. Box 1450, Alexandria, VA 22313-1450.**

If you need assistance in completing the form, call 1-800-PTO-9199 and select option 2.

Electronic Patent Application Fee Transmittal

Application Number:	
Filing Date:	
Title of Invention:	Handbag Hanger Hook
First Named Inventor/Applicant Name:	Jacklyn S. EASLICK
Filer:	Ming Chow/Megan Huan
Attorney Docket Number:	TP-EASJ-HIA2

Filed as Small Entity

Design Filing Fees

Description	Fee Code	Quantity	Amount	Sub-Total in USD(\$)
Basic Filing:				
Design application filing	2012	1	125	125
Design Search Fee	2112	1	60	60
Design Examination Fee	2312	1	80	80

Pages:

Claims:

Miscellaneous-Filing:

Petition:

Patent-Appeals-and-Interference:

Description	Fee Code	Quantity	Amount	Sub-Total in USD(\$)
Post-Allowance-and-Post-Issuance:				
Extension-of-Time:				
Miscellaneous:				
Total in USD (\$)				265

Electronic Acknowledgement Receipt

EFS ID:	13712195
Application Number:	29431801
International Application Number:	
Confirmation Number:	3337
Title of Invention:	Handbag Hanger Hook
First Named Inventor/Applicant Name:	Jacklyn S. EASLICK
Customer Number:	62439
Filer:	Ming Chow/Megan Huan
Filer Authorized By:	Ming Chow
Attorney Docket Number:	TP-EASJ-HIA2
Receipt Date:	11-SEP-2012
Filing Date:	
Time Stamp:	15:20:34
Application Type:	Design

Payment information:

Submitted with Payment	yes
Payment Type	Credit Card
Payment was successfully received in RAM	\$265
RAM confirmation Number	1944
Deposit Account	
Authorized User	

File Listing:

Document Number	Document Description	File Name	File Size(Bytes)/ Message Digest	Multi Part /.zip	Pages (if appl.)
-----------------	----------------------	-----------	----------------------------------	------------------	------------------

1	Specification	specs_TP-EASJ-HIA2.pdf	13022 1b25753e74b7dd7bf6be5acbfbcc529d322da42f	no	1
Warnings:					
Information:					
2	Drawings-only black and white line drawings	Figures_TP-EASJ-HIA2.pdf	160539 1d34942b3f851c852babad96e2cc9a3eb43bccde	no	8
Warnings:					
Information:					
3	Oath or Declaration filed	Declaration_TP-EASJ-HIA2.pdf	97892 20beb646caefed860ae09376cfd4e06e07752cab	no	3
Warnings:					
Information:					
4	Power of Attorney	POA_TP-EASJ-HIA2.pdf	64632 d4bb04fc17e880fff66de2be5a4334ba51eb9590	no	1
Warnings:					
Information:					
5	Fee Worksheet (SB06)	fee-info.pdf	32591 c5189657c54dcfcc41bde5f637fd9d7f8979f036	no	2
Warnings:					
Information:					
Total Files Size (in bytes):				368676	

This Acknowledgement Receipt evidences receipt on the noted date by the USPTO of the indicated documents, characterized by the applicant, and including page counts, where applicable. It serves as evidence of receipt similar to a Post Card, as described in MPEP 503.

New Applications Under 35 U.S.C. 111

If a new application is being filed and the application includes the necessary components for a filing date (see 37 CFR 1.53(b)-(d) and MPEP 506), a Filing Receipt (37 CFR 1.54) will be issued in due course and the date shown on this Acknowledgement Receipt will establish the filing date of the application.

National Stage of an International Application under 35 U.S.C. 371

If a timely submission to enter the national stage of an international application is compliant with the conditions of 35 U.S.C. 371 and other applicable requirements a Form PCT/DO/EO/903 indicating acceptance of the application as a national stage submission under 35 U.S.C. 371 will be issued in addition to the Filing Receipt, in due course.

New International Application Filed with the USPTO as a Receiving Office

If a new international application is being filed and the international application includes the necessary components for an international filing date (see PCT Article 11 and MPEP 1810), a Notification of the International Application Number and of the International Filing Date (Form PCT/RO/105) will be issued in due course, subject to prescriptions concerning national security, and the date shown on this Acknowledgement Receipt will establish the international filing date of the application.

Handbag Hanger Hook

I, Jacklyn S Easlick, have invented a new design for a handbag hanger hook, as set forth
5 in the following specification. The invention generally comprises two hooks or circular
curved portions vertically connected to each other by a slanted curved middle portion and
oriented at a 90 degree angle to each other. The top hook comprises approximately three
quarters of a circle and hangs on a closet rod or clothing rack, and the bottom hook
resembles a U-shape on which the straps of a handbag are hung. The top hook is
10 positioned approximately vertically above the lowest point of the bottom hook.

DESCRIPTION:

FIG. 1 is a perspective view of the handbag hanger hook;
FIG. 2 is a front elevational view thereof;
15 FIG. 3 is a rear elevational view thereof;
FIG. 4 is a right-side elevational view thereof;
FIG. 5 is a left-side elevational view thereof;
FIG. 6 is a bottom plan view thereof;
FIG. 7 is a top plan view thereof; and,
20 FIG. 8 is a perspective view thereof wherein the top hook is hung on a rod, with a
handbag hanging from the bottom hook.

The broken line showing the rod and handbag in FIG. 8 is included for the purpose of
showing environmental structure and forms no part of the claimed design.
25

CLAIM:

The ornamental design for a handbag hanger hook, as shown and described.

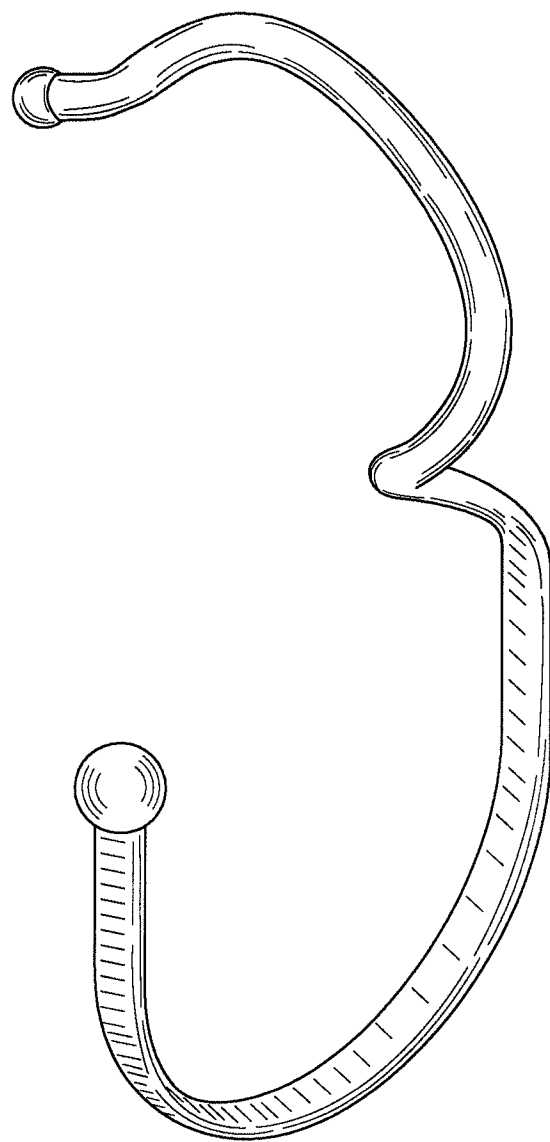

FIG. 1

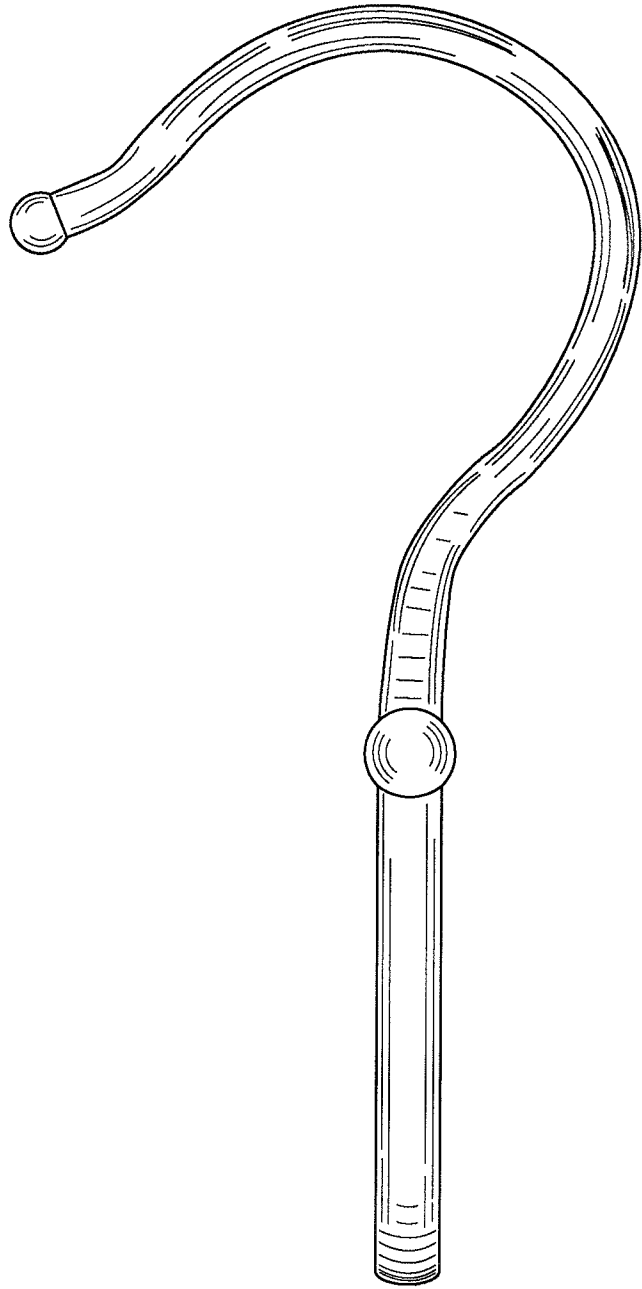

FIG. 2

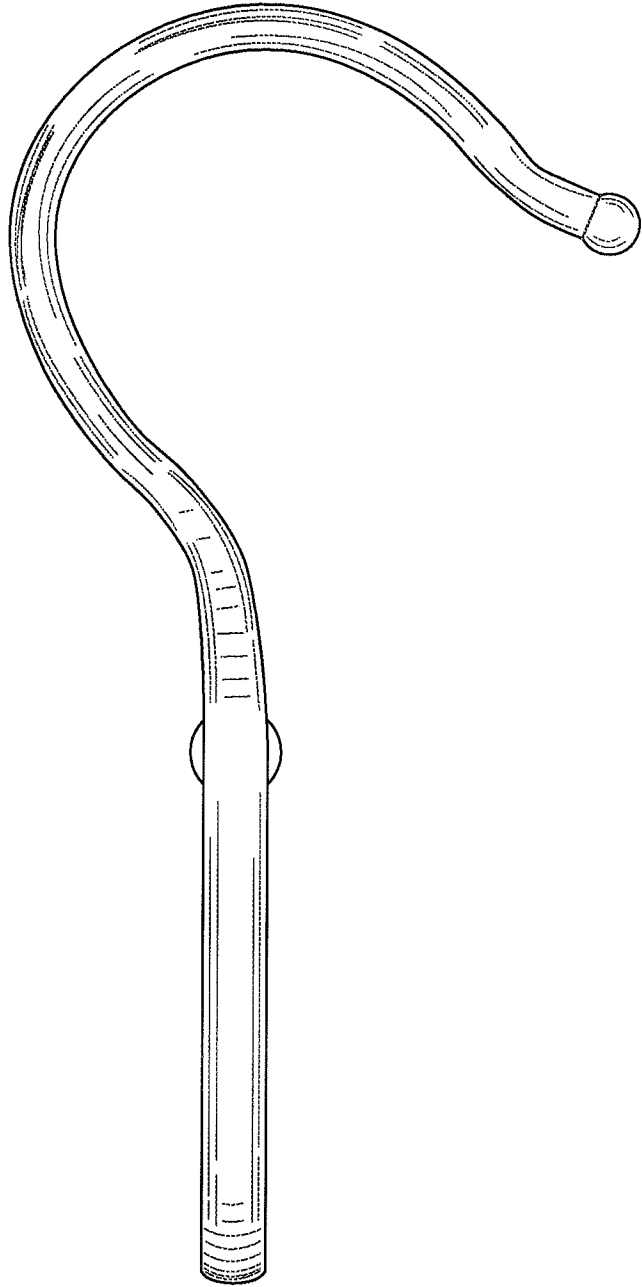

FIG. 3

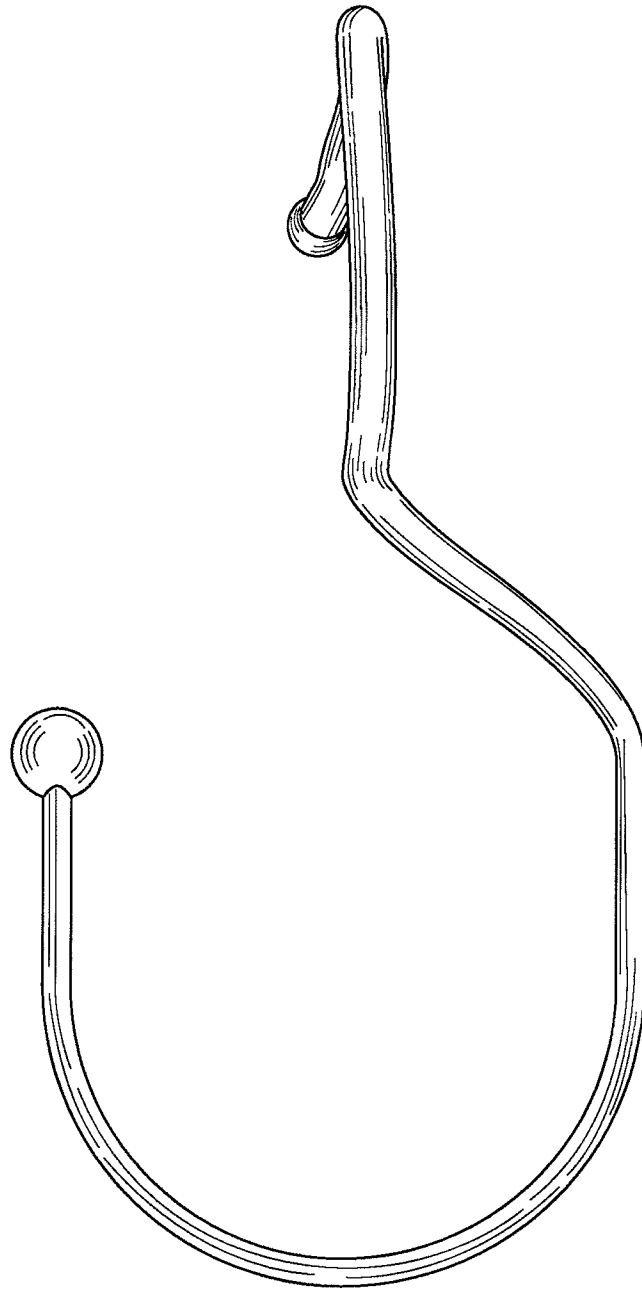

FIG. 4

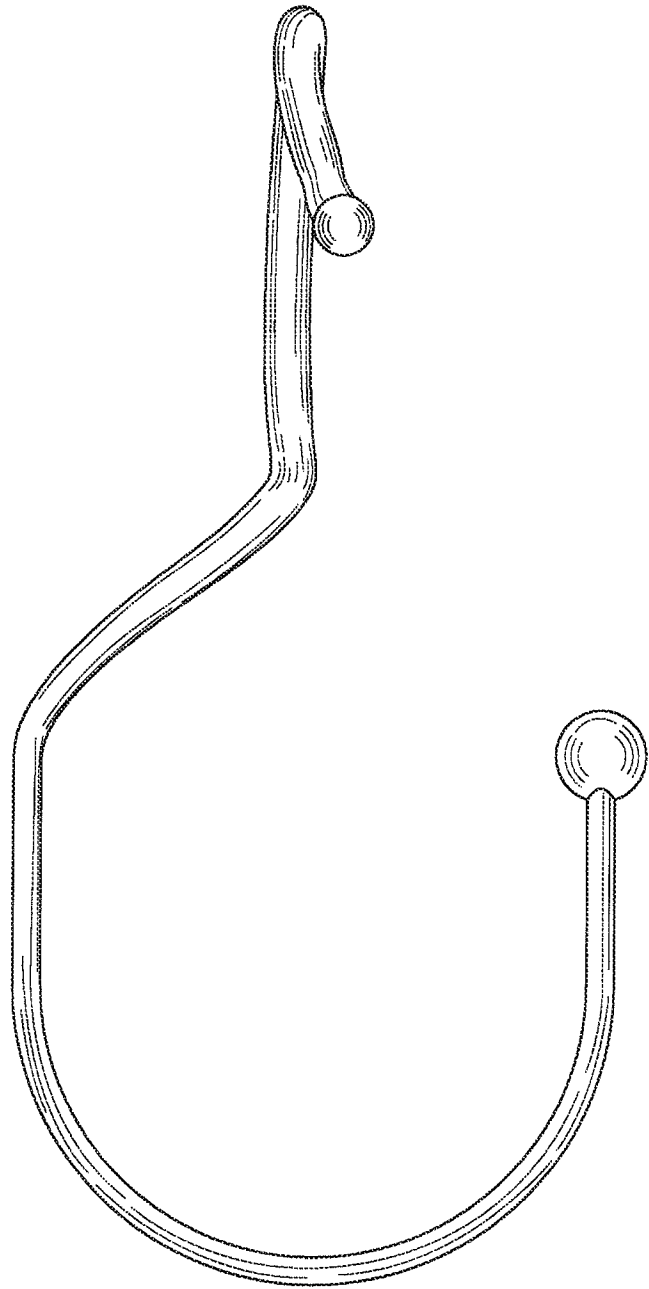

FIG. 5

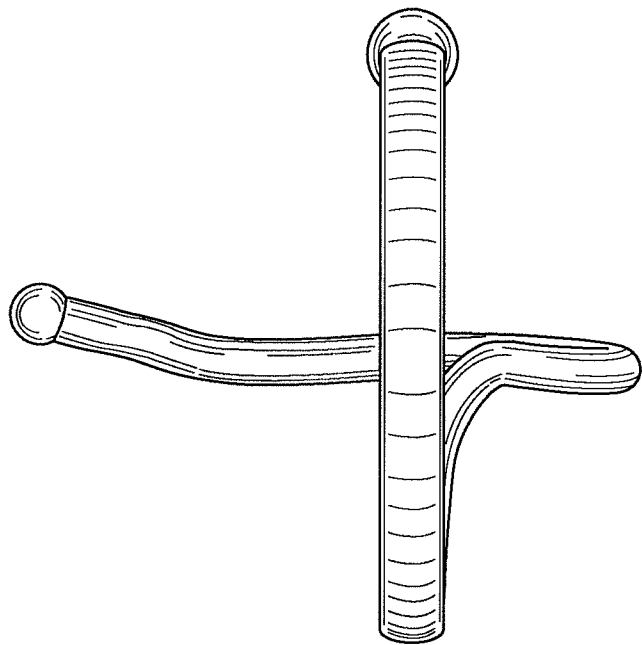

FIG. 6

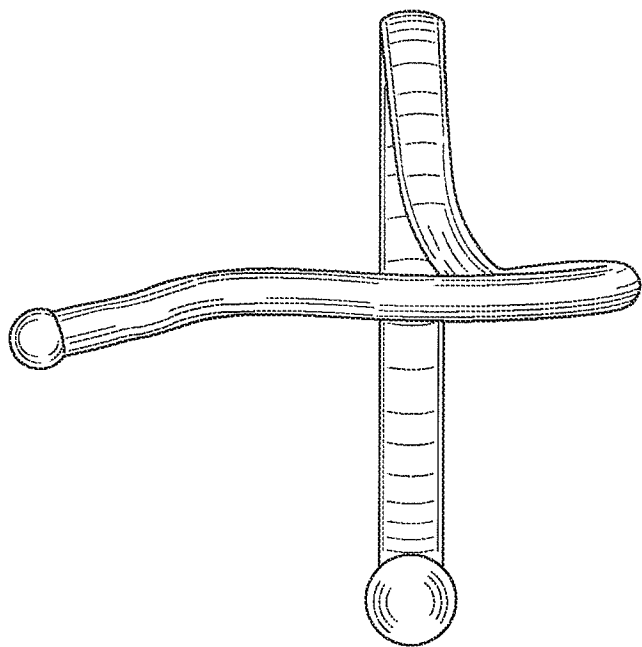

FIG. 7

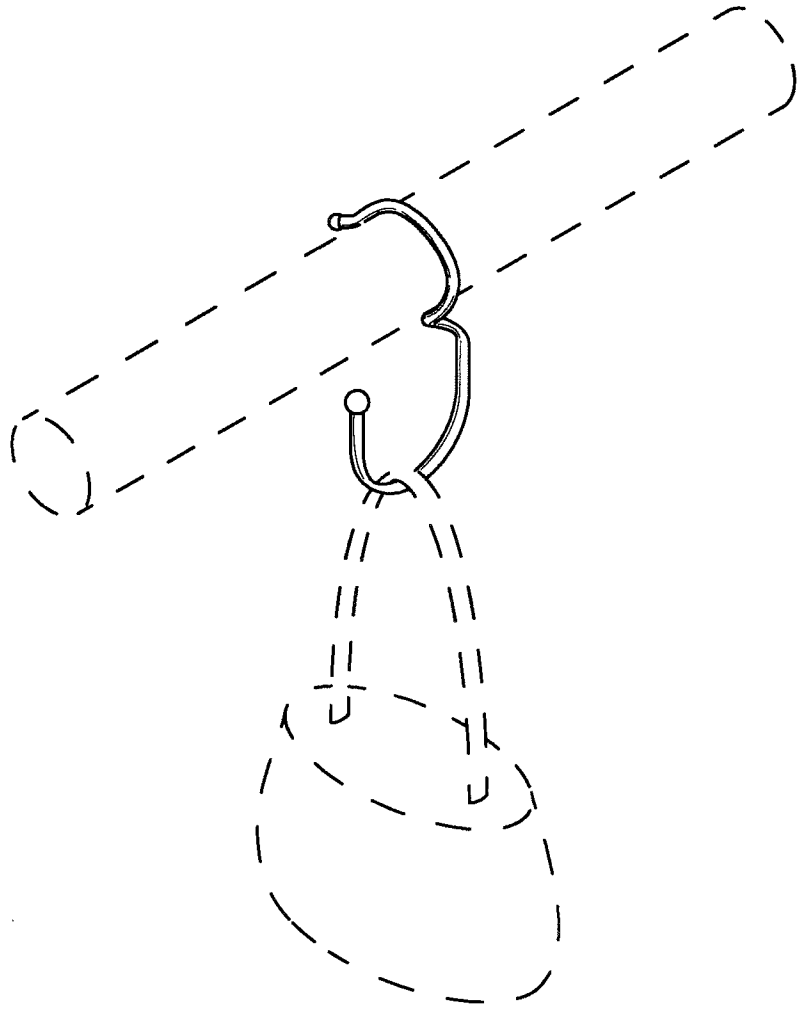

FIG. 8

Under the Paperwork Reduction Act of 1995, no persons are required to respond to a collection of information unless it contains a valid OMB control number.

DECLARATION FOR UTILITY OR DESIGN PATENT APPLICATION (37 CFR 1.63) <input checked="" type="checkbox"/> Declaration Submitted With Initial Filing OR <input type="checkbox"/> Declaration Submitted After Initial Filing (surcharge (37 CFR 1.16(f)) required)	Attorney Docket Number	TP-EASJ-HIA2
	First Named Inventor	Jacklyn S Easlick
	<i>COMPLETE IF KNOWN</i>	
	Application Number	
	Filing Date	
	Art Unit	
	Examiner Name	

I hereby declare that: (1) Each inventor's residence, mailing address, and citizenship are as stated below next to their name; and (2) I believe the inventor(s) named below to be the original and first inventor(s) of the subject matter which is claimed and for which a patent is sought on the invention titled:

Handbag Hanger Hook

(Title of the Invention)

the application of which

is attached hereto

OR

was filed on (MM/DD/YYYY) _____ as United States Application Number or PCT International Application Number _____ and was amended on (MM/DD/YYYY) _____ (if applicable).

I hereby state that I have reviewed and understand the contents of the above identified application, including the claims, as amended by any amendment specifically referred to above.

I acknowledge the duty to disclose information which is material to patentability as defined in 37 CFR 1.56, including for continuation-in-part applications, material information which became available between the filing date of the prior application and the national or PCT international filing date of the continuation-in-part application.

Authorization To Permit Access To Application by Participating Offices

If checked, the undersigned hereby grants the USPTO authority to provide the European Patent Office (EPO), the Japan Patent Office (JPO), the Korean Intellectual Property Office (KIPO), the World Intellectual Property Office (WIPO), and any other intellectual property offices in which a foreign application claiming priority to the above-identified patent application is filed access to the above-identified patent application. See 37 CFR 1.14(c) and (h). This box should not be checked if the applicant does not wish the EPO, JPO, KIPO, WIPO, or other intellectual property office in which a foreign application claiming priority to the above-identified patent application is filed to have access to the above-identified patent application.

In accordance with 37 CFR 1.14(h)(3), access will be provided to a copy of the above-identified patent application with respect to: 1) the above-identified patent application-as-filed; 2) any foreign application to which the above-identified patent application claims priority under 35 U.S.C. 119(a)-(d) if a copy of the foreign application that satisfies the certified copy requirement of 37 CFR 1.55 has been filed in the above-identified patent application; and 3) any U.S. application-as-filed from which benefit is sought in the above-identified patent application.

In accordance with 37 CFR 1.14(c), access may be provided to information concerning the date of filing the Authorization to Permit Access to Application by Participating Offices.

Under the Paperwork Reduction Act of 1995, no persons are required to respond to a collection of information unless it contains a valid OMB control number.

DECLARATION — Utility or Design Patent Application

Claim of Foreign Priority Benefits

I hereby claim foreign priority benefits under 35 U.S.C. 119(a)-(d) or (f), or 365(b) of any foreign application(s) for patent, inventor's or plant breeder's rights certificate(s), or 365(a) of any PCT international application which designated at least one country other than the United States of America, listed below and have also identified below, by checking the box, any foreign application for patent, inventor's or plant breeder's rights certificate(s), or any PCT international application having a filing date before that of the application on which priority is claimed.

Prior Foreign Application Number(s)	Country	Foreign Filing Date (MM/DD/YYYY)	Priority Not Claimed	Certified Copy Attached?	
				YES	NO
			<input type="checkbox"/>	<input type="checkbox"/>	<input type="checkbox"/>
			<input type="checkbox"/>	<input type="checkbox"/>	<input type="checkbox"/>
			<input type="checkbox"/>	<input type="checkbox"/>	<input type="checkbox"/>
			<input type="checkbox"/>	<input type="checkbox"/>	<input type="checkbox"/>

Additional foreign application number(s) are listed on a supplemental priority data sheet PTO/SB/02B attached hereto.

Under the Paperwork Reduction Act of 1995, no persons are required to respond to a collection of information unless it contains a valid OMB control number.

DECLARATION — Utility or Design Patent Application

Direct all correspondence to:	<input checked="" type="checkbox"/>	The address associated with Customer Number: 062439	OR	<input type="checkbox"/>	Correspondence address below
Name					
Address					
City		State		Zip	
Country		Telephone		Email	
WARNING:					
<p>Petitioner/applicant is cautioned to avoid submitting personal information in documents filed in a patent application that may contribute to identity theft. Personal information such as social security numbers, bank account numbers, or credit card numbers (other than a check or credit card authorization form PTO-2038 submitted for payment purposes) is never required by the USPTO to support a petition or an application. If this type of personal information is included in documents submitted to the USPTO, petitioners/applicants should consider redacting such personal information from the documents before submitting them to the USPTO. Petitioner/applicant is advised that the record of a patent application is available to the public after publication of the application (unless a non-publication request in compliance with 37 CFR 1.213(a) is made in the application) or issuance of a patent. Furthermore, the record from an abandoned application may also be available to the public if the application is referenced in a published application or an issued patent (see 37 CFR 1.14). Checks and credit card authorization forms PTO-2038 submitted for payment purposes are not retained in the application file and therefore are not publicly available. Petitioner/applicant is advised that documents which form the record of a patent application (such as the PTO/SB/01) are placed into the Privacy Act system of records DEPARTMENT OF COMMERCE, COMMERCE-PAT-7, System name: <i>Patent Application Files</i>. Documents not retained in an application file (such as the PTO-2038) are placed into the Privacy Act system of COMMERCE/PAT-TM-10, System name: <i>Deposit Accounts and Electronic Funds Transfer Profiles</i>.</p>					
I hereby declare that all statements made herein of my own knowledge are true and that all statements made on information and belief are believed to be true; and further that these statements were made with the knowledge that willful false statements and the like so made are punishable by fine or imprisonment, or both, under 18 U.S.C. 1001 and that such willful false statements may jeopardize the validity of the application or any patent issued thereon.					
NAME OF SOLE OR FIRST INVENTOR:			<input type="checkbox"/> A petition has been filed for this unsigned inventor		
Given Name (first and middle [if any]) Jacklyn S			Family Name or Surname Easlick		
Inventor's Signature /Jacklyn S. Easlick/			Date 7/25/2012		
Residence: City Rye	State NY	Country US	Citizenship US		
Mailing Address 222 Purchase St. #187					
City Rye	State NY	Zip 10580	Country US		
<input type="checkbox"/> Additional inventors or a legal representative are being named on the _____ supplemental sheet(s) PTO/SB/02A or 02LR attached hereto					

SCORE Placeholder Sheet for IFW Content

Application Number: 29431801

Document Date: 09/11/2012

The presence of this form in the IFW record indicates that the following document type was received in electronic format on the date identified above. This content is stored in the SCORE database.

- Drawing

Since this was an electronic submission, there is no physical artifact folder, no artifact folder is recorded in PALM, and no paper documents or physical media exist. The TIFF images in the IFW record were created from the original documents that are stored in SCORE.

To access the documents in the SCORE database, refer to instructions developed by SIRA.

At the time of document entry (noted above):

- Examiners may access SCORE content via the eDAN interface.
- Other USPTO employees can bookmark the current SCORE URL (<http://es/ScoreAccessWeb/>).
- External customers may access SCORE content via the Public and Private PAIR interfaces.

Cited References



(12) **United States Design Patent** (10) **Patent No.:** **US D475,278 S**
Williams (45) **Date of Patent:** **** Jun. 3, 2003**

(54) **SOCK HOOK**

(75) Inventor: **Arnold H. Williams**, Boxborough, MA (US)

(73) Assignee: **Christmas Cove Designs, Inc.**, Richmond, ME (US)

(**) **Term:** **14 Years**

(21) Appl. No.: **29/161,139**

(22) Filed: **May 23, 2002**

(51) **LOC (7) CI.** **08-05**

(52) **U.S. CI.** **D8/367; D3/328**

(58) **Field of Search** **D8/373, 367, 368; 211/113, 86.01, 106.01, 13.1; D11/42, 126, 130; 248/214, 215, 302-308, 309.1, 339, 341, 914, 497; D3/328, 304; D6/315, 317**

(56) **References Cited**

U.S. PATENT DOCUMENTS

2,473,086	A	*	6/1949	Montero	248/308
2,521,037	A	*	9/1950	Brinton	211/85.3
D244,883	S	*	6/1977	Rohrmuller	D3/328
D295,267	S	*	4/1988	Saraga	D11/42
5,816,558	A	*	10/1998	Sommer et al.	248/544
D401,840	S	*	12/1998	Goodman et al.	D8/367

* cited by examiner

Primary Examiner—Pamela Burgess

(74) *Attorney, Agent, or Firm*—Pandiscio & Pandiscio

(57) **CLAIM**

The ornamental design for a sock hook, as shown and described.

DESCRIPTION

FIG. 1 is a perspective view of a sock hook showing my new design, the broken lines shown are for illustrative purposes only and form no part of the claimed design;

FIG. 2 is an enlarged perspective view of the sock hook shown in FIG. 1;

FIG. 3 is a right side elevational view of the sock hook shown in FIG. 1;

FIG. 4 is a left side elevational view of the sock hook shown in FIG. 1;

FIG. 5 is a top plan view of the sock hook shown in FIG. 1;

FIG. 6 is a bottom plan view of the sock hook shown in FIG. 1;

FIG. 7 is a front elevational view of the sock hook shown in FIG. 1;

FIG. 8 is a rear elevational view of the sock hook shown in FIG. 1;

FIG. 9 is a perspective view of a second embodiment of the sock hook showing my new design, the broken lines shown are for illustrative purposes only and form no part of the claimed design;

FIG. 10 is an enlarged perspective view of the sock hook shown in FIG. 9;

FIG. 11 is a right side elevational view of the sock hook shown in FIG. 9;

FIG. 12 is a left side elevational view of the sock hook shown in FIG. 9;

FIG. 13 is a top plan view of the sock hook shown in FIG. 9;

FIG. 14 is a bottom plan view of the sock hook shown in FIG. 9;

FIG. 15 is a front elevational view of the sock hook shown in FIG. 9; and,

FIG. 16 is a rear elevational view of the sock hook shown in FIG. 9.

1 Claim, 8 Drawing Sheets

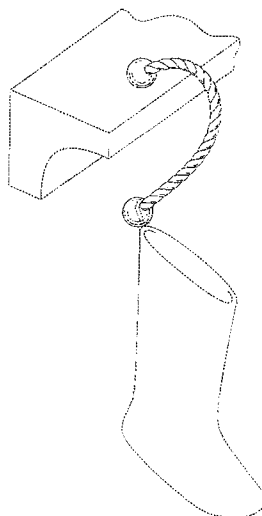

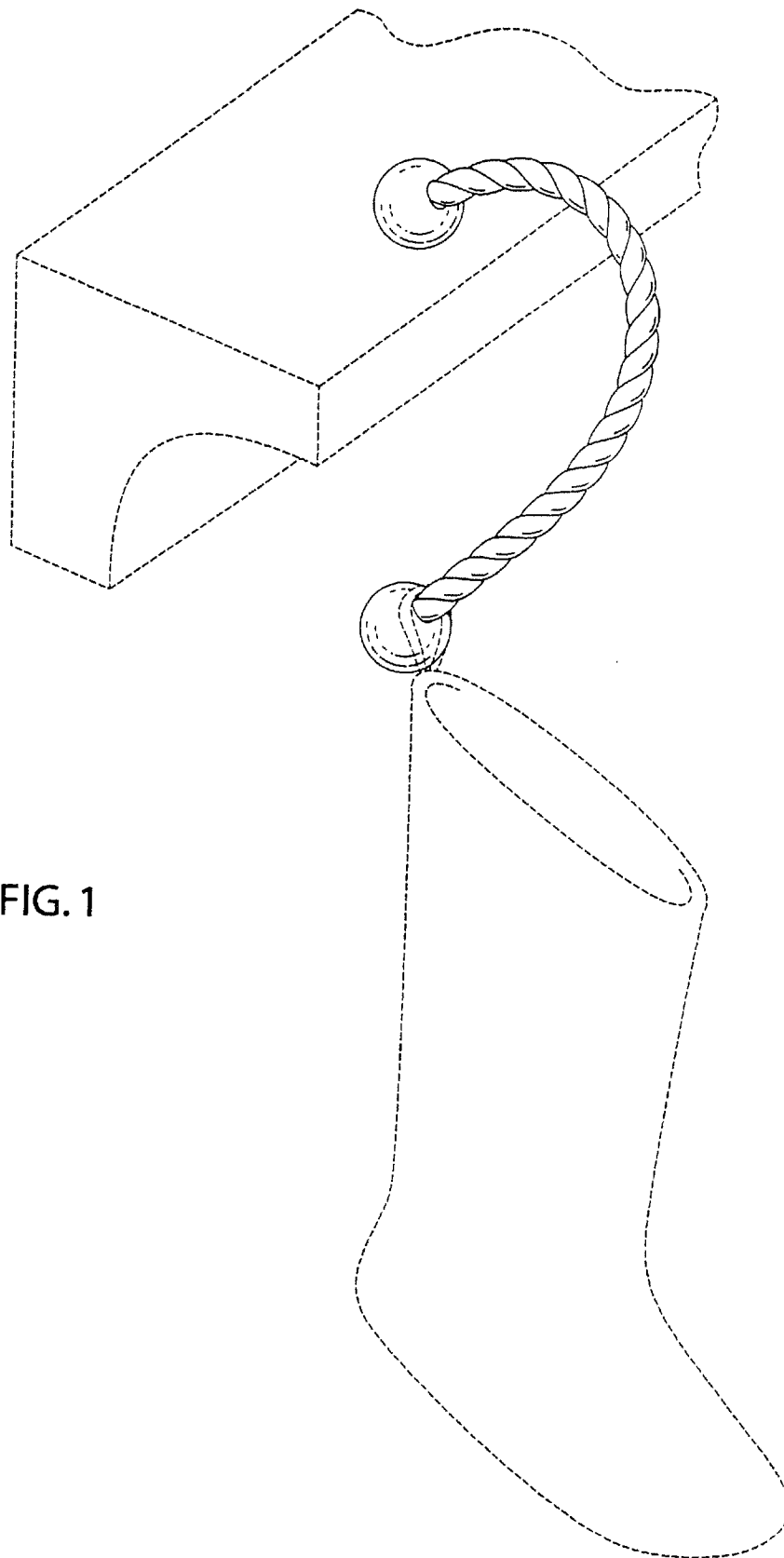

FIG. 1

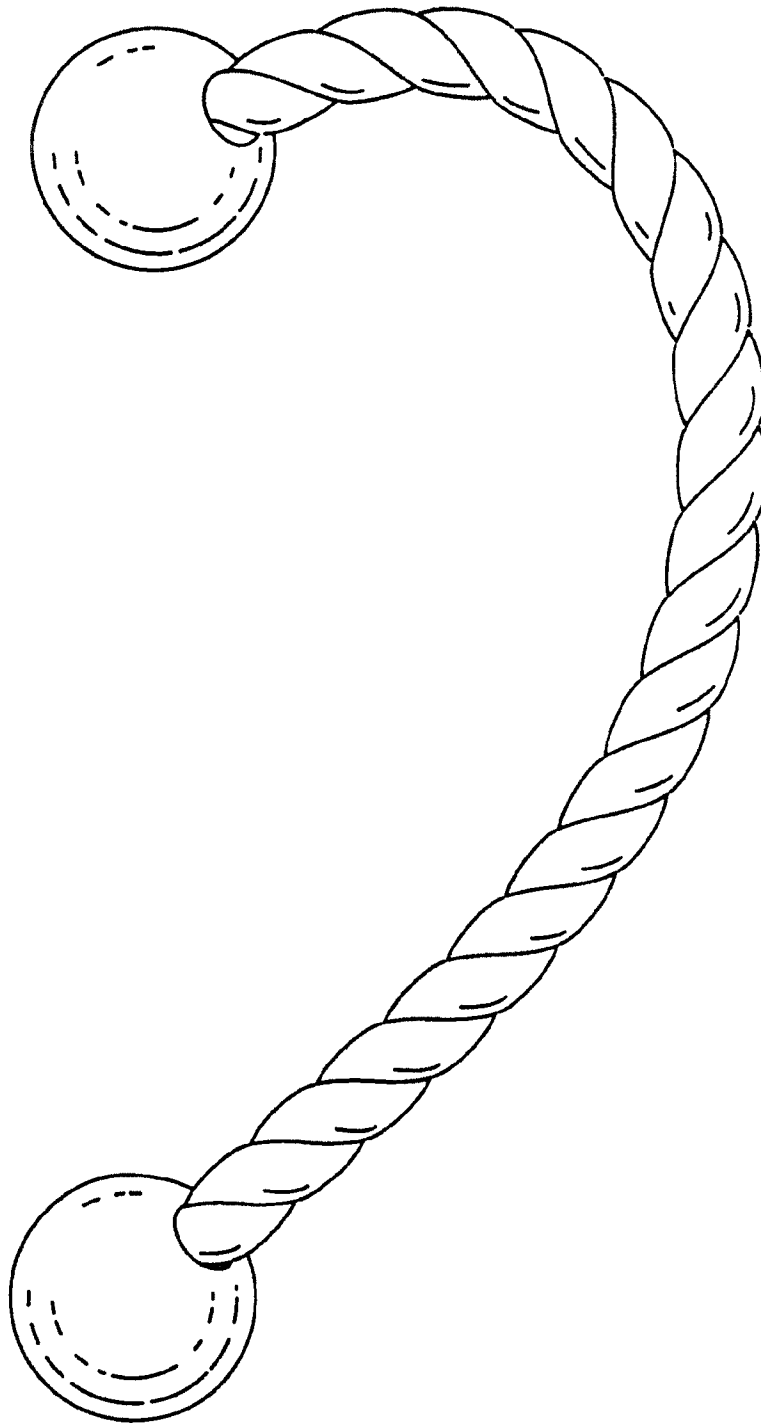

FIG. 2

FIG. 3

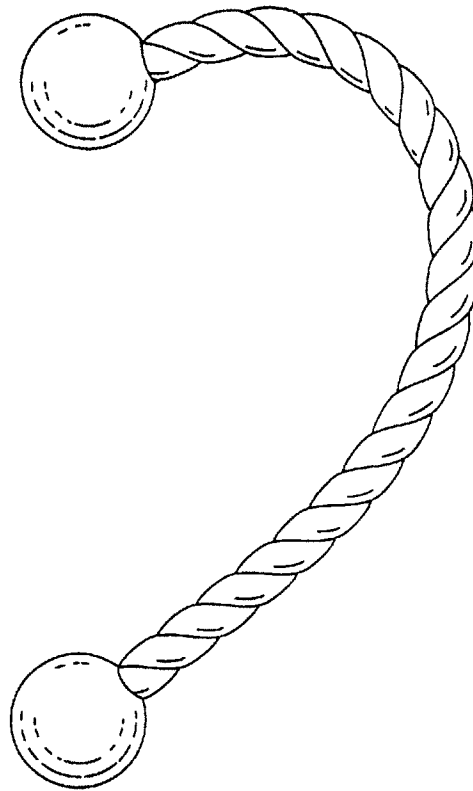

FIG. 4

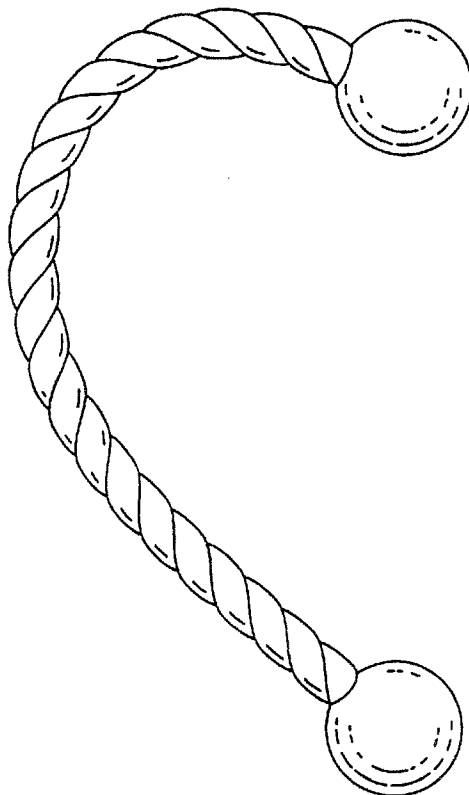



FIG. 5

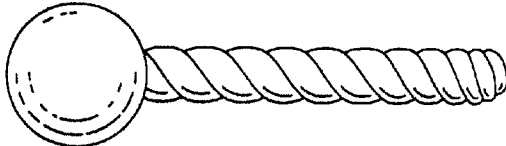

FIG. 6

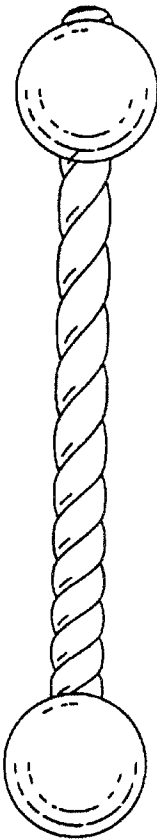

FIG. 7

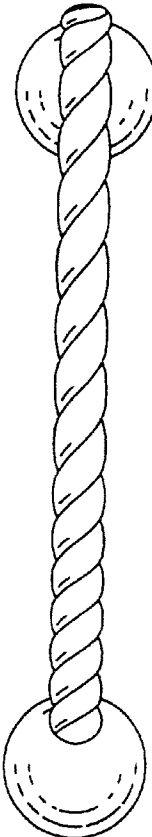

FIG. 8

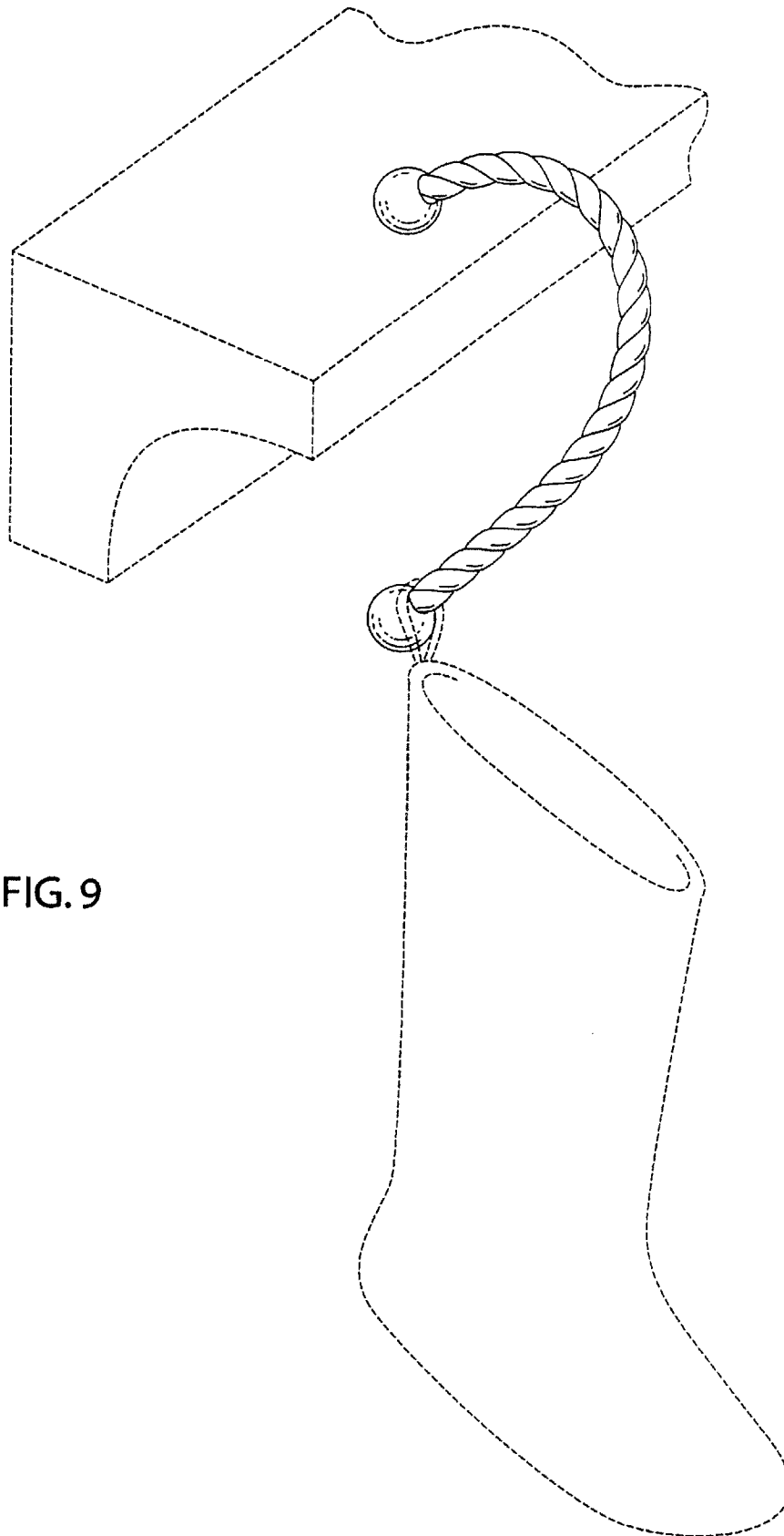

FIG. 9

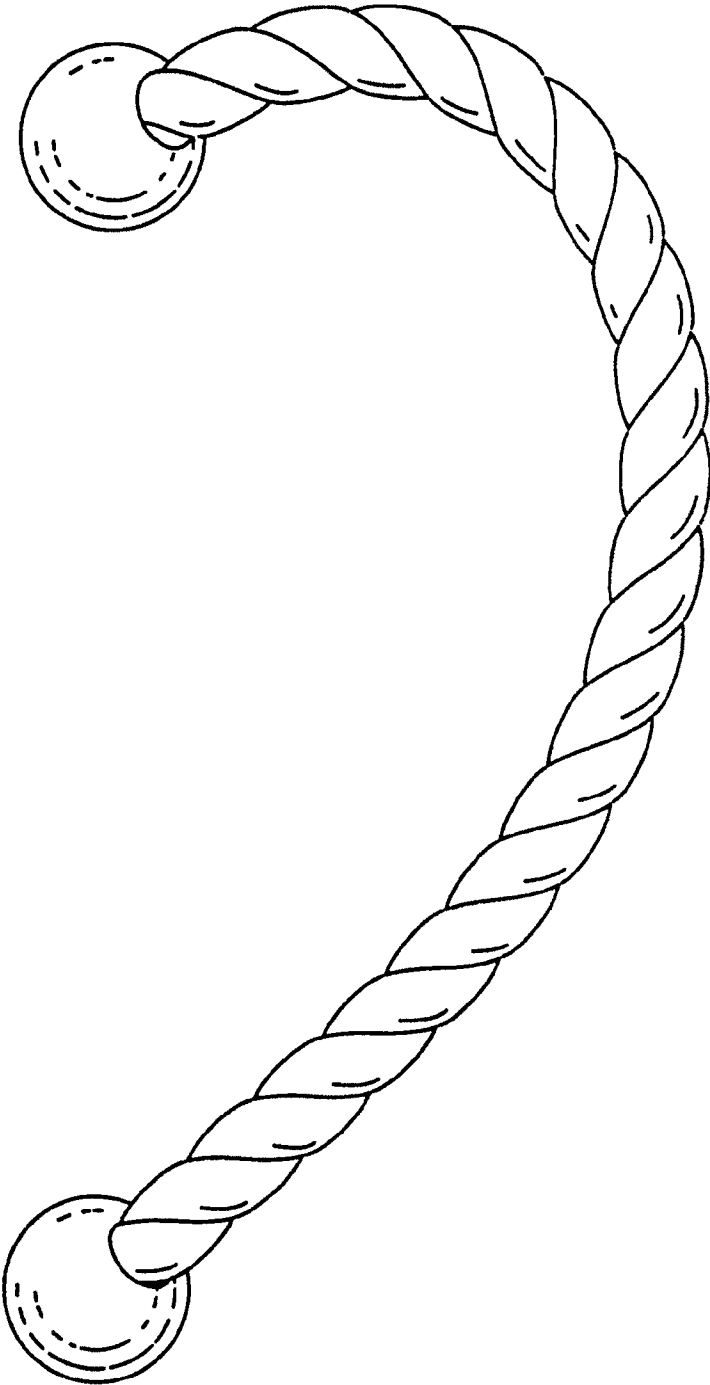

FIG. 10

FIG. 11

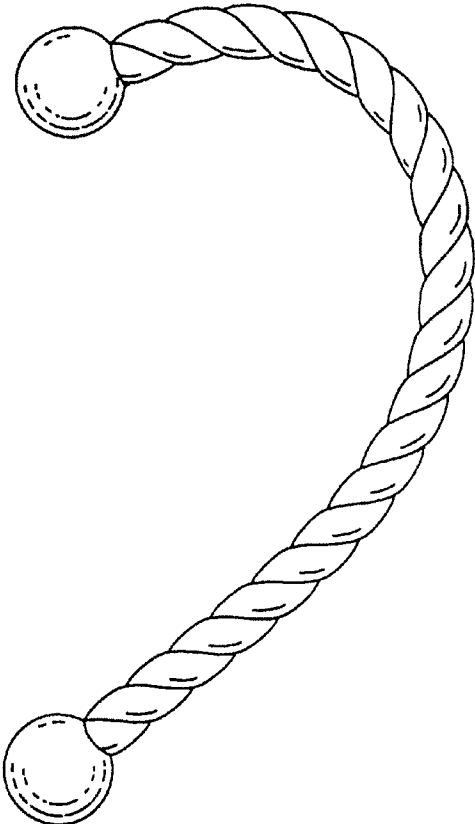
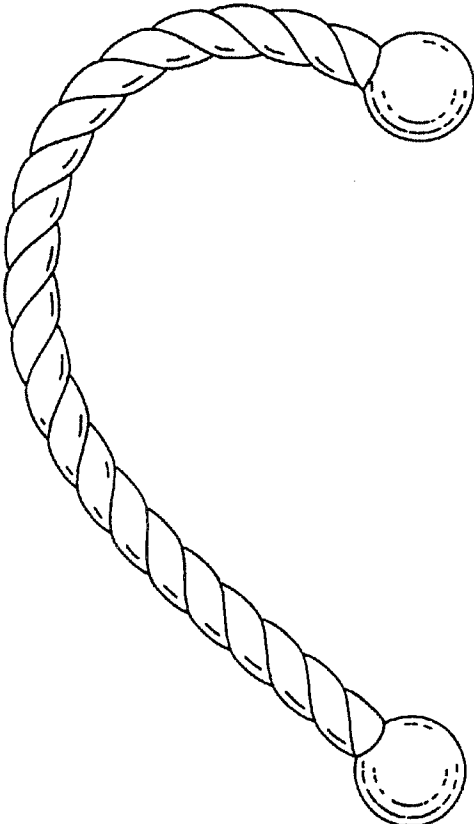

FIG. 12



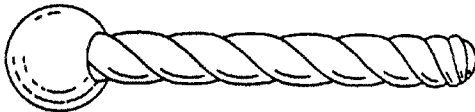

FIG. 13

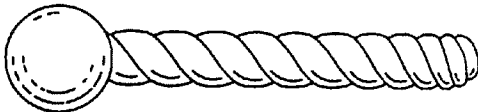

FIG. 14

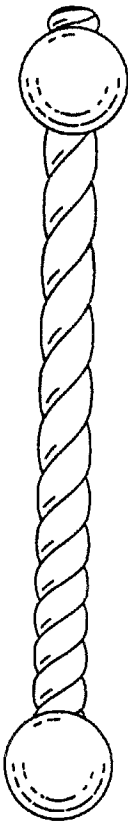

FIG. 15



FIG. 16



US005575446A

United States Patent [19]

[11] Patent Number: **5,575,446**

Swenson et al.

[45] Date of Patent: **Nov. 19, 1996**

[54] **CLAMPING DEVICE FOR SECURING CHRISTMAS TREE LIGHT WIRES AND/OR DECORATIONS TO CHRISTMAS TREES**

OTHER PUBLICATIONS

Instructions from package back for Lites Up Gutter Hook made by Gary Products Group, Lubbock, Texas. (no date supplied).

[75] Inventors: **Barbara Swenson**, P.O. Box 680096, Park City, Utah 84068; **D. Scott Beckham**, Summit County, Utah

Instructions from package back for Lites Up Ornament Hanger made by Gary Products Group, Lubbock, Texas (no date supplied).

[73] Assignee: **Barbara Swenson**, Sandy, Utah

Primary Examiner—Ramon O. Ramirez
Assistant Examiner—Michael J. Turgeon
Attorney, Agent, or Firm—Mallinckrodt & Mallinckrodt

[21] Appl. No.: **371,266**

[22] Filed: **Dec. 23, 1994**

[57] ABSTRACT

[51] Int. Cl.⁶ **F16B 45/00**

[52] U.S. Cl. **248/304; 248/306; 248/340**

[58] Field of Search **248/304, 303, 248/306, 340**

A device for clamping the wires of a string of decorative lights to Christmas tree branches is formed of a wholly integral length of flexible, but normally shape-retaining material doubled back on itself from opposite ends thereof at opposite sides of a diagonally oriented, substantially central part of the length of material to provide oppositely directed, open loop clamping portions whose openings are at respective opposite sides of but at the central part of the length of material. The flexible material is such that an opening to an open loop can expand to accept branches to be received and held in a clamping loop along with light string wires and can be rotated to open the opening when release of a branch is desired. A loop of the device is selected for clamping to a branch leaving the other loop to serve as a handle for manipulating the device and thereafter free for receiving a Christmas tree decoration.

[56] References Cited

U.S. PATENT DOCUMENTS

3,277,291	10/1966	Holbrook	240/10
3,488,025	1/1970	Rowland	248/304
3,582,641	6/1971	Choquette	240/10
3,870,206	3/1975	Feinberg	248/340
3,977,050	8/1976	Perez	24/150
4,209,945	7/1980	Dent et al.	47/84
4,285,072	8/1981	Morcher et al.	3/13
4,775,310	10/1988	Fischer	425/308
4,887,785	12/1989	Blaich	248/304
4,966,344	10/1990	Gary	248/317
4,979,714	12/1990	Russell et al.	248/303
5,103,380	4/1992	Lindner et al.	362/32

15 Claims, 2 Drawing Sheets

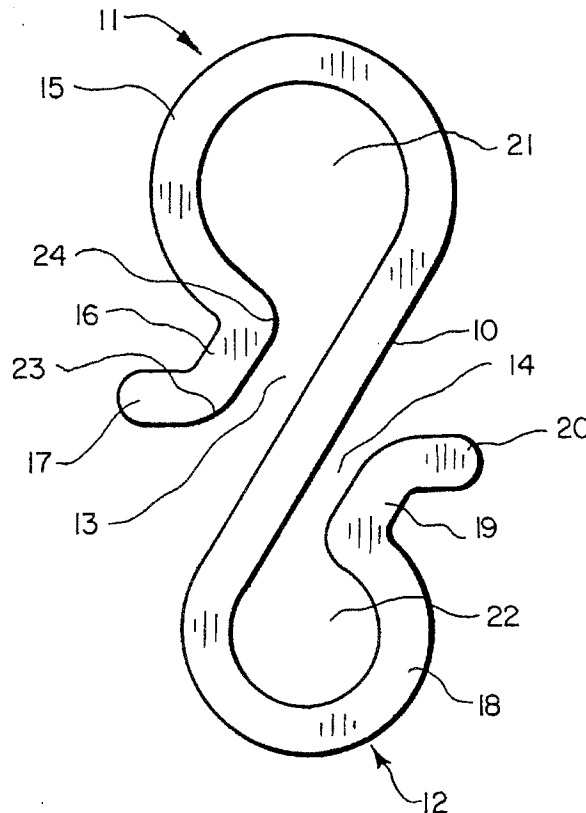

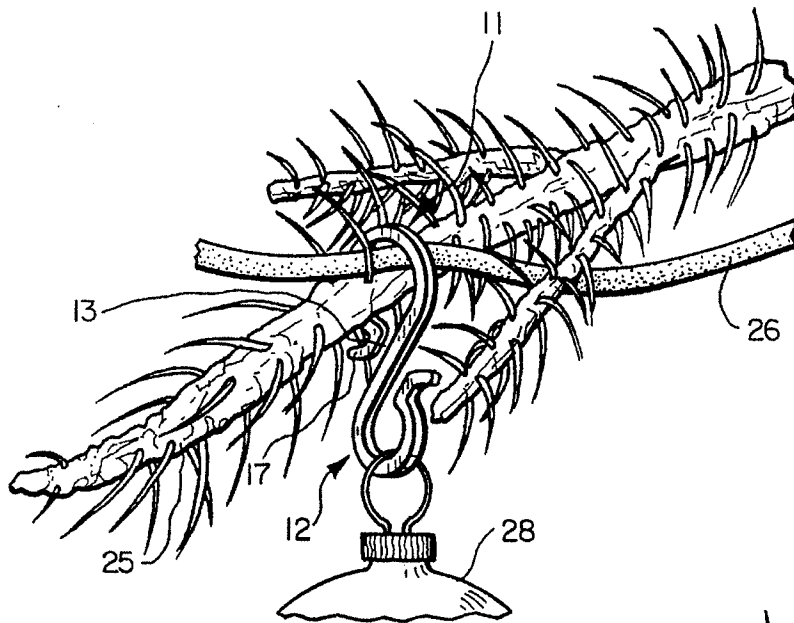

FIG. 3

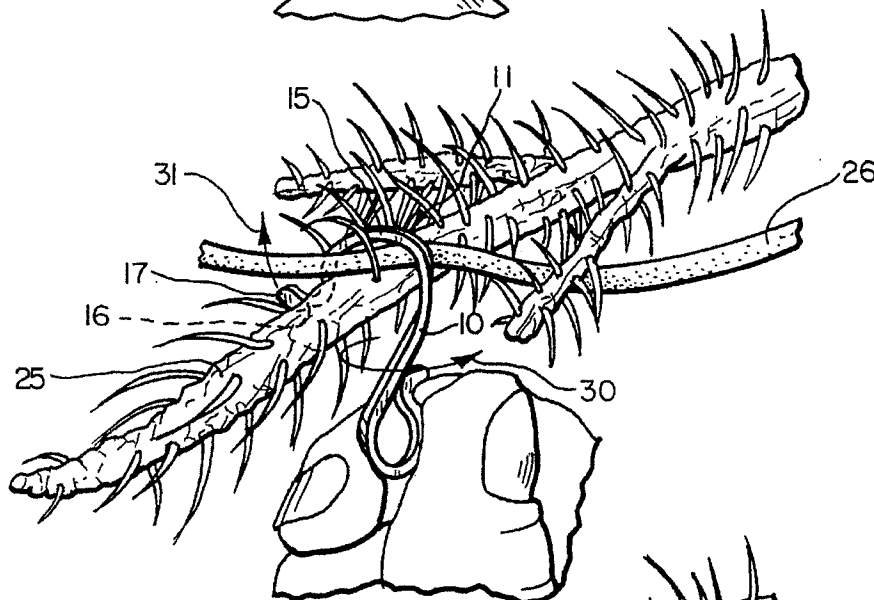

FIG. 4

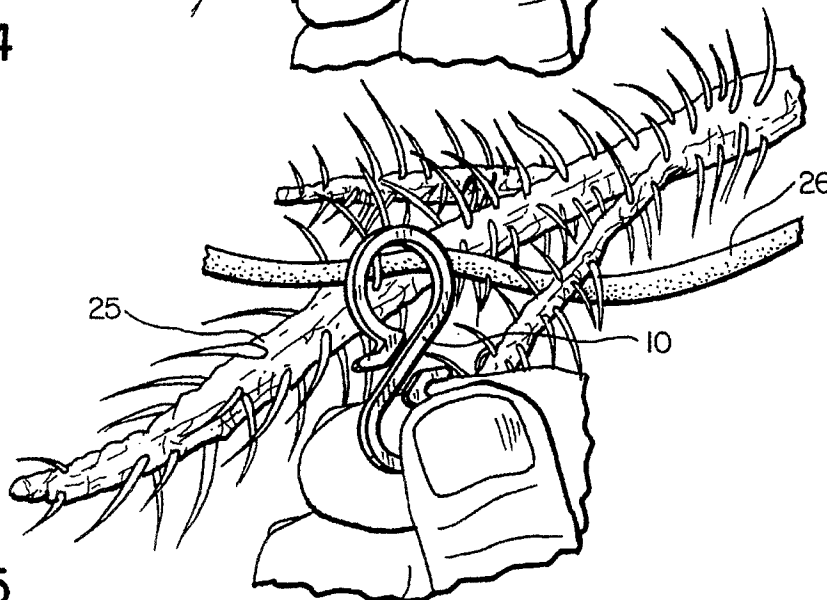

FIG. 5

CLAMPING DEVICE FOR SECURING CHRISTMAS TREE LIGHT WIRES AND/OR DECORATIONS TO CHRISTMAS TREES

BACKGROUND OF THE INVENTION

1. Field

The invention is in the field of securing Christmas tree lights, garlands, and ornaments to a Christmas tree.

2. State of the Art

Current practice in decorating Christmas trees is generally to drape the wires which connect Christmas tree light sockets with light bulbs therein from branch to branch of the tree to spread the lights around the tree. Generally the wires are not secured to the tree branches. In many instances this means that the wires can slip from the branches, and in some instances, it is difficult to extend the lights in a desired fashion between relatively widely spaced branches. With some light sets, loops in the wire at each light socket are provided with a slide bead over the wires so the loop can be placed about the end of a branch and the slide bead moved to close the loop around the branch to secure the light sockets to desired branches. Other light sockets are provided with clips of some type to enable the light socket to be clipped to a Christmas tree branch. However, the loops and clips generally are provided with relatively large light sockets, and the miniature light sets which have become popular generally do not include any means for securing a light socket to a branch. For some currently available light sets where an upright orientation of the light is important, such as lights which simulate candles, the light socket has a hand-operated spring clip on the bottom of the light socket so the light socket can be clipped to a branch in an upright position.

Similarly to strings of lights, tinsel garlands are generally draped from branch to branch with no means of securing the garland to a branch to hold it from sliding off.

SUMMARY OF THE INVENTION

According to the invention, a device for clamping the wires of a string of decorative lights to Christmas tree branches is formed of a wholly integral length of flexible, but normally shape-retaining material, that is doubled back on itself from opposite ends thereof at opposite sides of a diagonally oriented, substantially central part of the length of material to provide oppositely directed, open loop clamping portions whose openings are at respective opposite sides of but at the central part of the length of material. The clamping loops are generally of different sizes and either of the clamping loops may be selected for clamping a wire of a string of Christmas tree lights to a limb or branch of a Christmas tree. Selection is generally based on the size of the branch to which the device is applied. The other loop provides a handle for manipulating the device and, when in place on a branch, is free for receiving a Christmas tree ornament or other decoration, if desired. Such other loop could, if desired, receive the wire of the decorative light set or could receive a loop of a second device of the invention if additional length is required. The flexible material from which the device is made allows entry of a tree branch into a clamping loop and allows the device to be twisted so that, when desired, a loop thereof can be easily twisted and removed from a branch.

The diagonally oriented, substantially central part of the length of material forms a substantially straight central portion from the ends of which extend the open loop

clamping portions. These open loop clamping portions include arcuate portions which extend through at least approximately 270° from the ends of the central portion to double back on the central portion and the arcuate portions flow into relatively short straight portions which extend, preferably substantially parallel to the straight central portion and preferably spaced somewhat from the central portion, to provide openings leading into substantially circular areas formed by the arcuate portions. The relatively short straight portions terminate in end portions which extend at angles outwardly from the central portion to act as guides to the openings between the relatively short portions and the central portion. The transitions between the relatively short straight portion and the end portion are preferably of a relatively large radius compared to the radius of the transitions between the arcuate portions and the relatively short straight portions. This makes it easier to slide the device onto a branch than to slide it off of a branch.

THE DRAWINGS

The best mode presently contemplated for carrying out the invention is illustrated in the accompanying drawings, in which:

FIG. 1 is a side elevation of a device of the invention;

FIG. 2, a perspective view of the device being applied to a Christmas tree branch and decorative light set wire to hold the wire in position on the branch;

FIG. 3, a perspective view similar to that of FIG. 2, showing the device installed on the branch;

FIG. 4, a perspective view similar to that of FIG. 2, but showing the device twisted as it is prepared for removal from the branch; and

FIG. 5, a perspective view similar to that of FIG. 2, but show the device as removed from the branch.

DETAILED DESCRIPTION OF THE ILLUSTRATED EMBODIMENTS

Referring to FIG. 1, the clip or clamping device of the invention is formed of a length of flexible, but normally shape-retaining, material that is doubled back on itself from opposite ends thereof at opposite sides of a diagonally oriented, substantially central part or portion 10 of the length to provide oppositely directed, open loop clamping portions 11 and 12, which open at passage 13 and 14, respectively, at respective opposite sides of central portion 10. Both open loop clamping portions 11 and 12 open along central portion 10.

The central portion 10 is elongate and substantially straight. At each end of the straight central portion 10 is an arcuate portion wherein the clip doubles back on itself to form the open loop elements at each end extending from the central portion 10 in opposite directions. Thus, arcuate portion 15 extends from one end of straight central portion 10, through at least approximately 270° to a relatively short straight portion 16, which preferably is substantially parallel to straight central portion 10, which extends from arcuate portion 15 toward the opposite end of central portion 10. The relatively short straight portion 16 smoothly joins an end portion 17 which extends at an angle outwardly away from the central portion 10. Arcuate portion 18 extends from the opposite end of straight central portion 10, through at least approximately 270° to a relatively short straight portion 19, again which is preferably substantially parallel to straight central portion 10, which extends toward the one end of

central portion 10. Relatively short straight portion 19 smoothly joins an end portion 20 which extends at an angle outwardly away from the central portion 10. Arcuate portions 15 and 18 extend from central portion 10 in opposite directions as do end portions 17 and 20. While the relatively short straight portions 16 and 19 could be immediately adjacent central portion 10, it is preferred that they be spaced a short distance from central portion 10 to form the openings or passages 13 between central portion 10 and relatively short straight portion 16, and passage 14 between central portion 10 and relatively short straight portion 19. Passage 13 leads to a substantially circular area 21 formed by arcuate portion 15 and passage 14 leads to substantially circular area 22 formed by arcuate portion 18.

It is important for operation of the device that it be made of a flexible material which is normally shape-retaining which will allow flexing of the open loop portions 11 or 12 to accept and receive branches of a Christmas tree therein. Thus, the arcuate portions 15 or 18 will flex so that the relatively short straight portions 16 or 19 move outwardly whereby the passages 13 or 14 leading to the circular areas 21 or 22 can be enlarged to the normal diameter of the circular areas 21 or 22. This allows passage of a Christmas tree branch into the circular area 21 or 22. The material must also be such that it will return to its original configuration after such flexing so that the arcuate portions 15 or 18 will surround more than one-half of a received branch through the extent of the arc and hold the device on the branch. Polyolefins such as polypropylene and polyethylene have been found to be satisfactory materials. Himont 1050 polypropylene works well.

Each of the open loop portion 11 and 12 will preferably be of different size, i.e., the radius of each of the arcuate portions 15 and 18 will be different, whereby a larger loop can be used for a larger branch and a smaller loop can be used for a smaller branch. However, the loops could be of substantially equal size if desired for particular applications.

As can be seen in FIG. 1, the transition 23 along passage 13 from end portion 17 to relatively short straight portion 16 is smoothly radiused as is the transition 24 from arcuate portion 15 to relatively short straight portion 16. The radius of curvature for transition 23 is relatively large compared to the radius of curvature for transition 24. It is presently preferred that the radius of transition 23 be about double the radius of transition 24. The result of this difference is that it is easier for a branch to cam passage 13 open so the branch can move into circular area 21 than it is for a branch in circular area 21 to cam passage 13 open so that it can move out of circular 21. This is desirable so that it is easy to pull the device over a branch to thereby secure the device to a branch, but so that it is difficult, when once secured, for the branch to come out of the device. This tends to prevent unwanted release of the device from the branch. It is preferred that if a tangent be drawn to the midpoint of the transition, that for transition 23, it intersects the central portion 10 at an angle of between 30° and 45° and that for transition 24 it intersect the central portion 10 at an angle of between 60° and 80°. The transitions for the smaller open loop portion 12 will preferably be substantially the same as for the larger open loop portion 11.

For general indoor Christmas tree use, it is preferred that the clamping device of the invention be as unobtrusive or unnoticeable as possible. It is therefore preferred that the device be sized so that it fits within and does not extend beyond the needles extending from an average fir tree branch. It has been determined that generally an overall device length of about one and one-quarter inch meets this

requirement. With such length, the width of the device will be about five-eighths inch. The arcuate portion 15 of the larger open loop portion 11 has a radius of about 0.187 inch and the arcuate portion 18 of the smaller open loop portion 12 has a radius of about 0.125 inch. The radius of the transition 23 from the end portion 17 to the relatively short straight portion 16 is about 0.125 inch while the radius of the transition 24 from the arcuate portion 15 to the relatively short straight portion 16 is about 0.063 inch. The device is made of a length of polypropylene of rectangular cross section with a thickness of about 0.09 inch and a width of about 0.125 inch. Larger passage 13 is about 0.09 inch in width, about the same size as the thickness of the material from which the device is made, and the smaller passage 14 is about two-thirds the size of the larger passage at about 0.06 inch. The lengths of the two relatively short straight portions 16 and 19 are equal and are about 0.09 inches, equal to the width of the larger passage 13. End portions 17 and 20 extend outwardly at an angle of about 60° from the central portion 10.

The above measurements are currently preferred for indoor Christmas tree use, however, it should be realized that the device of the invention could be made in various sizes and, particularly, could be made in a larger size for use with large outdoor trees whose branches are generally larger than indoor Christmas trees.

In use, a user selects the particular open loop portion 11 or 12 to be used with and receive a particular branch, such as loop 11 in FIGS. 2-5, and holds the other open loop portion, 12 in FIGS. 2-5, as a handle to manipulate the device. The entrance to open loop portion 11, formed by end portion 17 leading to passage 13 is positioned adjacent a selected branch 25. If the device is being used to secure a wire 26 of a decorative light set in one of the securement arrangements of the invention, the wire 26 is placed over the branch as shown in FIG. 2 and the entrance to open loop portion 11 is positioned at the intersection of the branch and wire. The device is pulled against the branch in the direction of arrow 27. The loop will flex to enlarge passage 13 so that branch 25 will pass through passage 13 as the device is moved in the direction of the arrow 27 and pass into circular area 21. Open loop portion 11 will close around branch 25 to secure the device to the branch as shown in FIG. 3. Wire 26 is then held in place on branch 25 as shown in FIG. 3. With the current arrangement of the end portion 17 and transition 23 therefrom to relatively short straight portion 16, the device slips easily onto branch 25. With the described arrangement of the transition 24 from the arcuate portion 15 to relative short straight portion 16, it is difficult to slide the device from branch 25. A branch 25 does not have to completely fill circular area 21 for the device to be secured thereto. The branch 25 merely need be larger than passage 13 so that it does not easily pass back through the passage to release the device. Thus, the device will clamp a wire to the branch and hold it in position and will stay on the branch even when loose about the branch.

With the device of the invention secured to branch 25 as shown in FIG. 3, open loop portion 12 is available to receive and hang an ornament 28. Alternately, light string wire 26, rather than being held in place over branch 25 by open loop portion 11 around branch 25, could be positioned in and held in place by open loop portion 12. Tinsel and other garlands could be secured and held to branch 25 in the same manner as wire 26. Further, if a light wire, garland, ornament, or other item is to be supported in position at a greater distance below branch 25, one or more additional devices could be used, one hung from the other end-to-end, to support such item at any desired distance from the branch.

5

When it is desired to remove the device from the branch 25, a user could, using the entrance to passage 13 formed by end portion 17, flex open loop portion 11 to open passage 13 to allow the device to be removed from branch 25. A preferred method of removal, because it is generally easier, is to grasp the device and twist it as shown by arrow 30 in FIG. 4 to flex open loop portion 11 and straight central portion 10 so that the end of the loop formed by relatively short straight portion 16 and end portion 17 are rotated approximately 90° from their original positions to thereby open passage 13 as shown in FIG. 4, and while in that position, the device is moved upwardly in the direction of arrow 31 and removed from the branch 25. After removal, the material returns to its original configuration and the removed device is shown in FIG. 5.

While it is preferred that relatively short straight portions 16 and 19 extend parallel to central portion 10, this is not necessary and in some instances, particularly with the smaller loop, warpage during cooling of the device after molding may result in portion 19 extending at an angle to central relatively short straight portion 10.

While it is preferred that the branch on which the device is secured fits within the space normally formed by the arcuate portion, with the materials used and the configuration of the device as shown, even if the branch is somewhat bigger than the opening normally formed by the arcuate portion, the device will flex and effectively clamp and hold the branch.

Whereas this invention is here illustrated and described with reference an embodiment thereof presently contemplated as the best mode of carrying out such invention in actual practice, it is to be understood that various changes may be made in adapting the invention to different embodiments without departing from the broader inventive concepts disclosed herein and comprehended by the claims that follow.

We claim:

1. A device for clamping the wires of a string of Christmas tree lights to Christmas tree branches and at the same time providing for attachment of a tree decoration, comprising a wholly integral length of flexible but normally shape-retaining material that is doubled back on itself from opposite ends thereof at opposite sides of a diagonally oriented, substantially central part of said length to provide oppositely directed, open loop clamping portions whose openings are at respective opposite sides of but at said central part of said length, said openings formed by relatively short straight portions substantially parallel to the central part of said length, whereby either of said clamping loops may be selected for clamping of a wire of a string of Christmas tree lights to a branch of the Christmas tree, leaving the other free for receiving a Christmas tree decoration.

2. A device according to claim 1, wherein the flexible, normally shape-retaining material is a polyolefin.

3. A device according to claim 2, wherein the polyolefin is polypropylene.

4. A device according to claim 1, wherein the clamping loops are of different sizes so that selection of the clamping loop is based upon the size of the branch to which the wire is to be clamped.

5. A device for securing the wire of a decorative light string or an ornament to a Christmas tree comprising:

6

an elongate, substantially straight central portion having opposite ends;

a first arcuate portion extending in a direction from one end of the central portion through an arc of at least approximately 270° to a first arcuate portion end;

a first relatively short straight portion extending from the first arcuate portion end toward the opposite end of the substantially straight central portion, said first relatively short straight portion being substantially parallel with said substantially straight central portion and having a first relatively short portion end toward said opposite end;

a first end portion extending from the first relatively short portion end at an angle outwardly away from the central portion;

a second arcuate portion extending from the opposite end of the central portion in a direction opposite to the direction of the first arcuate portion through an arc of at least approximately 270° to a second arcuate portion end;

a second relatively short straight portion extending from the second arcuate portion end toward the one end of the substantially straight central portion, said second relatively short straight portion being substantially parallel with said substantially straight central portion and having a second relatively short portion end toward said one end; and

a second end portion extending from the second relatively short portion end at an angle outwardly away from the central portion;

all portions of said device being unitarily formed of a flexible, normally shape-retaining material to allow said first arcuate portion to bend to allow a tree branch to pass between the central portion and first relatively short straight portion to be received within a space within the first arcuate portion and to allow said first arcuate portion to be twisted sufficiently when desired to allow escape of a received tree branch from the space within the first arcuate portion.

6. A device according to claim 5, wherein the first and second relatively short straight portions are spaced from the central portion to provide an opening therebetween.

7. A device according to claim 5, wherein the flexible material allows the second arcuate portion to bend to allow a tree branch to pass between the central portion and the second relatively short straight portion to be received within a space within the second arcuate portion and to allow the second arcuate portion to be twisted sufficiently when desired to allow escape of a received tree branch from the space within the second arcuate portion.

8. A device according to claim 5, wherein each arcuate portion extends at a constant radius along its length.

9. A device according to claim 8, wherein the first arcuate portion has a first radius and the second arcuate portion has a second radius, and wherein the first and second radii are different, whereby the space within one arcuate portion is larger than the space within the other arcuate portion so that larger branches may be received within the larger space.

10. A device according to claim 5, including a smooth arcuate transition of substantially constant radius from the first end portion to the first relatively short portion and a smooth arcuate transition of substantially constant radius from the first arcuate portion to the first relatively short portion, wherein the radius of the transition from the first

7

end portion to the first relatively short portion is larger than the radius of the transition from the first arcuate portion to the first relatively short portion, whereby it is easier to slide the device onto a branch than it is to slide the device off of a branch.

11. A device according to claim 10, wherein the larger radius is about twice the smaller radius.

12. A device according to claim 10, including a smooth arcuate transition of substantially constant radius from the second end portion to the second relatively short portion and a smooth arcuate transition of substantially constant radius from the second arcuate portion to the second relatively short portion, wherein the radius of the transition from the

8

second end portion to the second relatively short portion is larger than the radius of the transition from the second arcuate portion to the second relatively short portion, whereby it is easier to slide the device onto a branch than it is to slide the device off of a branch.

13. A device according to claim 12, wherein the larger radius is about twice the smaller radius.

14. A device according to claim 5, wherein the flexible, normally shape-retaining material is a polyolefin.

15. device according to claim 14, wherein the polyolefin is polypropylene.

* * * * *



US00D493092S1

(12) **United States Design Patent** (10) **Patent No.:** **US D493,092 S**
Kalat (45) **Date of Patent:** **** Jul. 20, 2004**

(54) **SNAP-TYPE UTILITY HOOK**

(74) *Attorney, Agent, or Firm—Alix, Yale & Ristas, LLP*

(75) **Inventor:** **Edward W. Kalat**, Southington, CT (US)

(57) **CLAIM**

The snap-type utility hook, as shown and described.

(73) **Assignee:** **Southington Tool & Manufacturing Corporation**, Plantsville, CT (US)

DESCRIPTION

(**) **Term:** **14 Years**

(21) **Appl. No.:** **29/187,188**

FIG. 1 is a front view of a first embodiment snap-type utility hook showing my new design;

FIG. 2 is a left side view of the snap-type utility hook of FIG. 1;

FIG. 3 is a right side view of the snap-type utility hook of FIG. 1;

FIG. 4 is a rear view of the snap-type utility hook of FIG. 1;

FIG. 5 is a top plan view of the snap-type utility hook of FIG. 1;

FIG. 6 is a bottom plan view of the snap-type utility hook of FIG. 1;

FIG. 7 is a front view of a second embodiment of a snap-type utility hook showing the new design;

FIG. 8 is a left side view of the snap-type utility hook of FIG. 7;

FIG. 9 is a right side view of the snap-type utility hook of FIG. 7;

FIG. 10 is a rear view of the snap-type utility hook of FIG. 7;

FIG. 11 is a top plan view of the snap-type utility hook of FIG. 7;

FIG. 12 is a bottom plan view of the snap-type utility hook of FIG. 7;

FIG. 13 is a frontal perspective view of the snap-type utility hook of FIG. 7; and,

FIG. 14 is a rear perspective view of the snap-type utility hook of FIG. 1.

(22) **Filed:** **Jul. 29, 2003**

(51) **LOC (7) Cl.** **08-05**

(52) **U.S. Cl.** **D8/367; D8/370**

(58) **Field of Search** **D8/367, 370; 248/302-303; 24/601.4, 298, 599.8, 599.9, 600.9, 265 R, 265 H**

(56) **References Cited**

U.S. PATENT DOCUMENTS

25,082 A *	8/1859	Pollack	24/600.9
437,380 A *	9/1890	Lundborg	24/600.9
721,071 A *	2/1903	McGill	248/302
804,273 A *	11/1905	Smith	24/600.9
5,913,479 A *	6/1999	Westwood, III	24/298
6,230,375 B1 *	5/2001	Catlett	24/599.8
6,427,296 B1 *	8/2002	Chang	24/601.4

OTHER PUBLICATIONS

I-FUJII Enterprise, Co. Ltd., p. 55, Aug. 15, 1995, hook located in middle of page.*

* cited by examiner

Primary Examiner—Holly Baynham

1 Claim, 3 Drawing Sheets

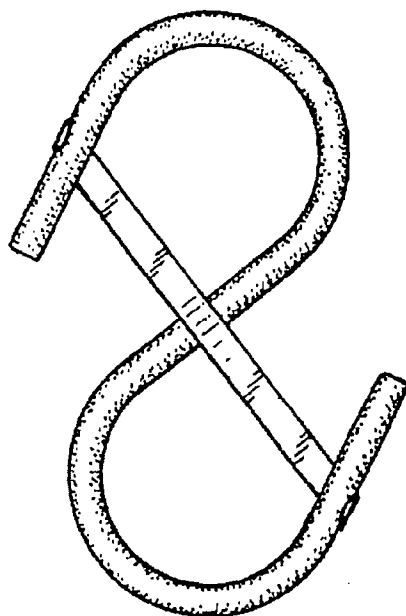



FIG. 5

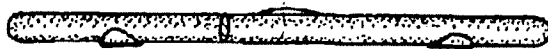

FIG. 2

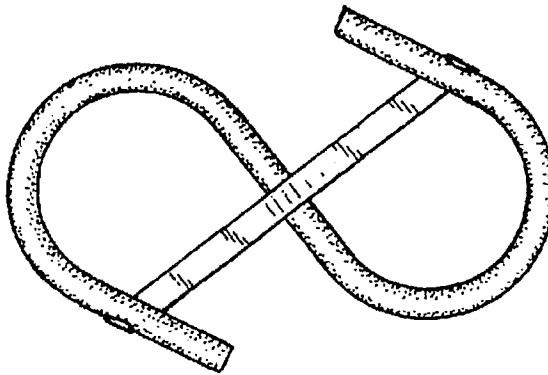

FIG. 1



FIG. 3

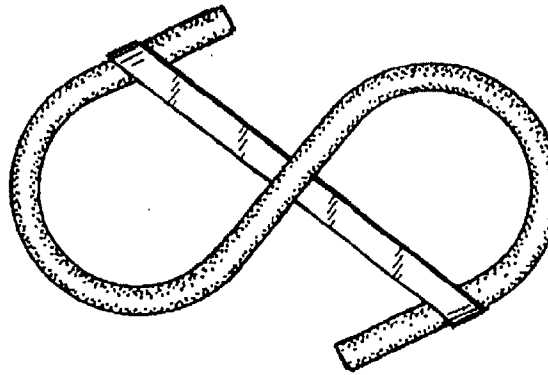

FIG. 4



FIG. 6

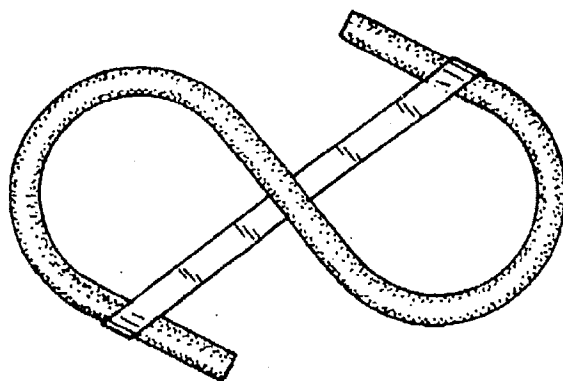

FIG. 10



FIG. 9



FIG. 11

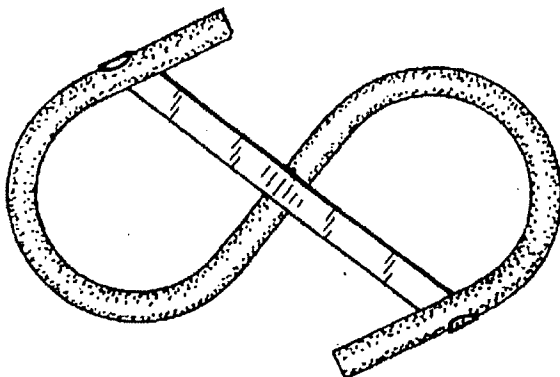

FIG. 7



FIG. 12



FIG. 8

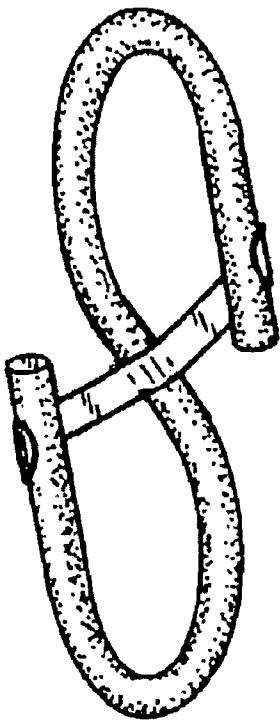

FIG. 13

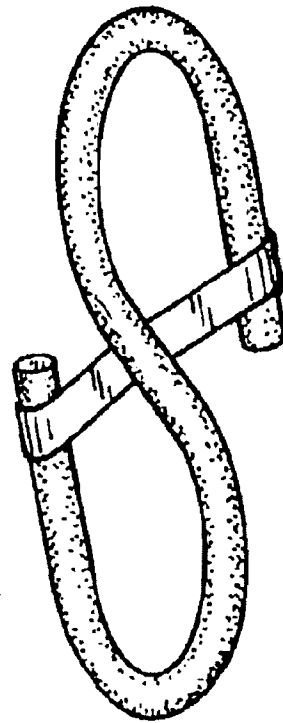

FIG. 14



(12) **United States Design Patent**
Walker

(10) **Patent No.:** **US D560,924 S**
(45) **Date of Patent:** **** Feb. 5, 2008**

(54) **COMBINATION SHOWER CURTAIN HOOK AND PICTURE FRAME**

(75) **Inventor:** **David Lamont Walker**, Chester, PA (US)

(73) **Assignee:** **Zenith Products Corp.**, New Castle, DE (US)

(**) **Term:** **14 Years**

(21) **Appl. No.:** **29/247,257**

(22) **Filed:** **Jun. 8, 2006**

(51) **LOC (8) Cl.** **06-04**

(52) **U.S. Cl.** **D6/396; D6/300; D8/367**

(58) **Field of Classification Search** **D6/300-314, D6/315, 323, 328, 580, 370, 397; D8/367, D8/349; 211/13.1, 85.3, 86.01, 183; 160/39, 160/330; 248/339, 301, 304, 214-215; D3/210; 16/87.2; 40/700, 725, 717**
See application file for complete search history.

(56) **References Cited**

U.S. PATENT DOCUMENTS

- 267,938 A 11/1882 Rings
- 396,604 A 1/1889 Rings
- 397,419 A 2/1889 Day
- 400,348 A 3/1889 Lawrence
- 460,793 A 10/1891 Rings
- 578,424 A 3/1897 Rings
- 659,534 A 10/1900 Kroder
- 686,124 A 11/1901 Parker
- 699,507 A 5/1902 Erich
- 805,919 A 11/1905 Kroder
- 913,261 A 2/1909 Clark
- 1,020,776 A 3/1912 Parry
- 1,224,624 A 5/1917 Fjellman
- 1,857,293 A 5/1932 Vroom
- 2,320,003 A 5/1943 Madan
- 3,223,373 A * 12/1965 Molinaro 248/339
- 3,315,297 A 4/1967 Bender
- 4,887,785 A * 12/1989 Blaich 248/339
- 4,979,712 A 12/1990 Rios

- D350,279 S 9/1994 Tate
- 5,575,446 A * 11/1996 Swenson et al. 248/304
- D398,516 S * 9/1998 Brown et al. D8/370
- D400,425 S * 11/1998 Goodman et al. D8/367
- D428,802 S * 8/2000 Villano et al. D8/367
- D439,144 S 3/2001 Ho
- D441,584 S 5/2001 Ho
- D456,696 S 5/2002 Samelson
- D459,201 S 6/2002 Michaelson
- D469,682 S * 2/2003 Gary et al. D8/367
- 6,530,120 B2 3/2003 Samelson
- D485,431 S * 1/2004 Hsu D3/210
- D489,249 S * 5/2004 Moore D8/367
- D495,242 S * 8/2004 Kucera et al. D8/367
- D496,849 S * 10/2004 Abdi et al. D8/367
- D505,315 S * 5/2005 Snell D8/367
- D505,614 S * 5/2005 Barrese D8/367
- D515,912 S * 2/2006 Snell D8/367
- D535,110 S * 1/2007 Hoernig D6/323

* cited by examiner

Primary Examiner—Caron D. Veynar
Assistant Examiner—Sydney R Buffalow
(74) *Attorney, Agent, or Firm*—Akin Gump Strauss Hauer & Feld LLP

(57) **CLAIM**

The ornamental design for a combination shower curtain hook and picture frame, as shown and described.

DESCRIPTION

FIG. 1 is a front perspective view of a combination shower curtain hook and picture frame in accordance with my new design;
FIG. 2 is a front elevational view thereof;
FIG. 3 is a rear elevational view thereof;
FIG. 4 is a left side elevational view thereof;
FIG. 5 is a right side elevational view thereof;
FIG. 6 is a top plan view thereof; and,
FIG. 7 is a bottom plan view thereof.

1 Claim, 4 Drawing Sheets

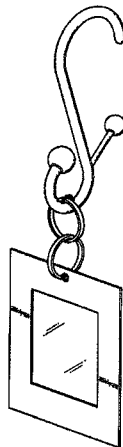

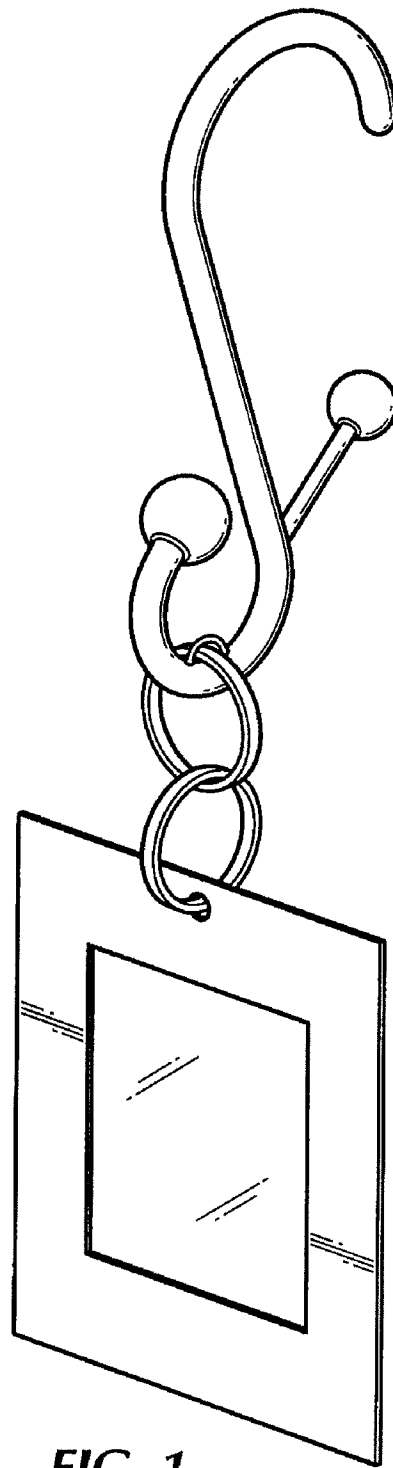

FIG. 1

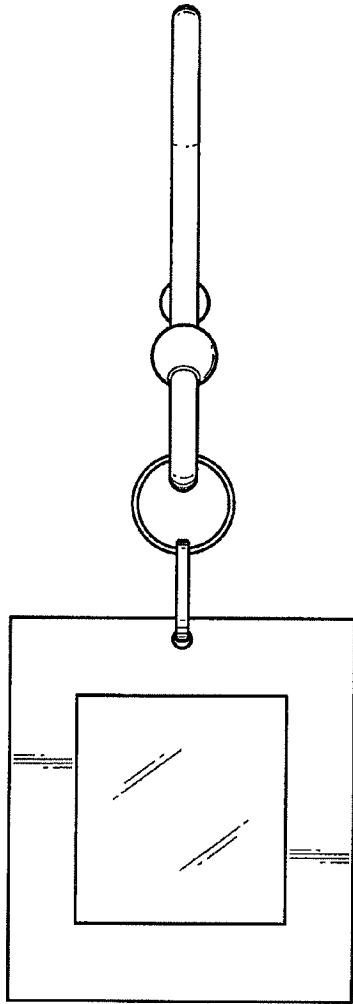

FIG. 2

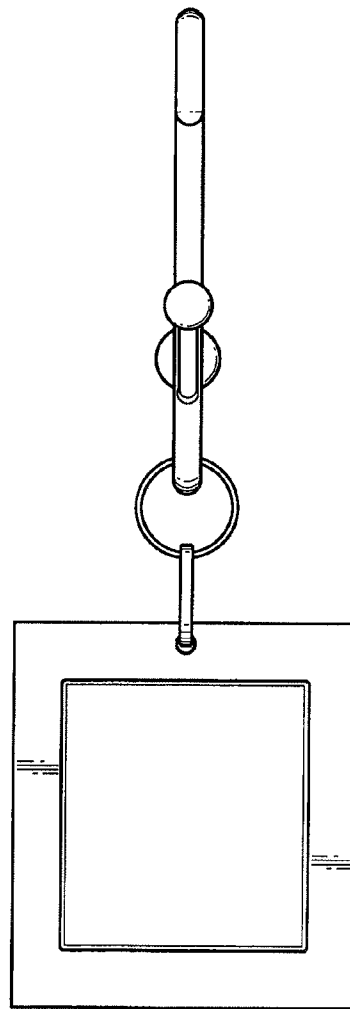

FIG. 3

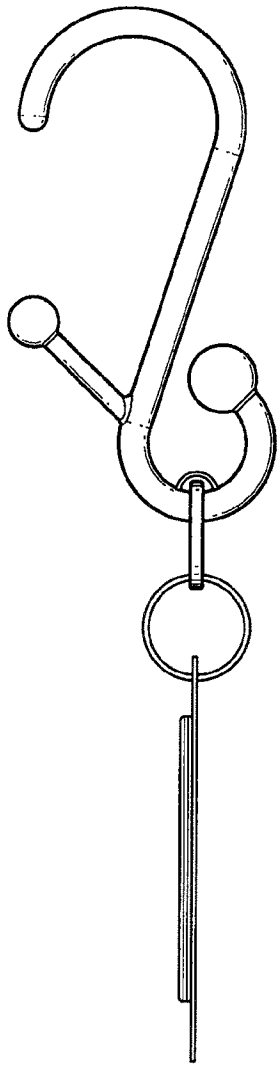

FIG. 4

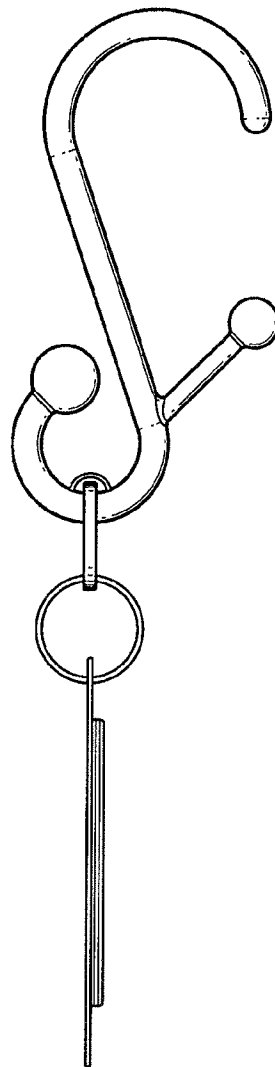

FIG. 5

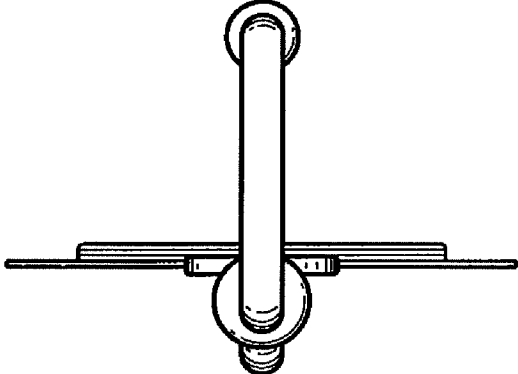

FIG. 6

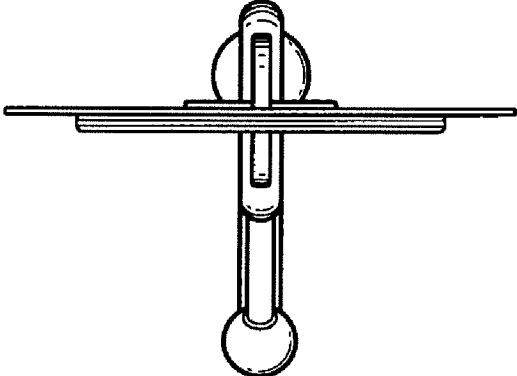

FIG. 7



US00D644438S

(12) **United States Design Patent**
Brucker

(10) **Patent No.:** **US D644,438 S**

(45) **Date of Patent:** **** Sep. 6, 2011**

(54) **HANGER FOR A PURSE OR THE LIKE**

(76) **Inventor:** **Lester A. Brucker**, Chokoloskee, FL (US)

(**) **Term:** **14 Years**

(21) **Appl. No.:** **29/364,377**

(22) **Filed:** **Jun. 23, 2010**

(51) **LOC (9) Cl.** **03-01**

(52) **U.S. Cl.** **D3/328**

(58) **Field of Classification Search** D3/328;
D8/367, 370; D6/323; 248/215, 302-303

See application file for complete search history.

(56) **References Cited**

U.S. PATENT DOCUMENTS

D229,870 S *	1/1974	Czarny	D3/328
D384,505 S *	10/1997	Stewart	D3/328
D400,425 S *	11/1998	Goodman et al.	D8/367
D408,723 S *	4/1999	Goodman et al.	D8/367
D429,899 S *	8/2000	Schwartz	D6/327
D435,733 S *	1/2001	Osterholt	D3/328

D465,653 S *	11/2002	Fuschillo	D3/328
D514,319 S *	2/2006	King et al.	D3/328
7,322,554 B2 *	1/2008	Caroselli et al.	248/304
D596,859 S *	7/2009	Castaline et al.	D3/328
D599,188 S *	9/2009	Ingalsbe et al.	D8/328
D611,330 S *	3/2010	Barrese	D8/367

* cited by examiner

Primary Examiner — Holly Baynham

(57) **CLAIM**

For the ornamental design of a hanger for a purse or the like, as shown and described.

DESCRIPTION

FIG. 1 is a perspective view of the hanger

FIG. 2 is a front elevation view

FIG. 3 is a left side elevation view, the right side being a mirror image; and,

FIG. 4 is a rear elevation view.

1 Claim, 4 Drawing Sheets

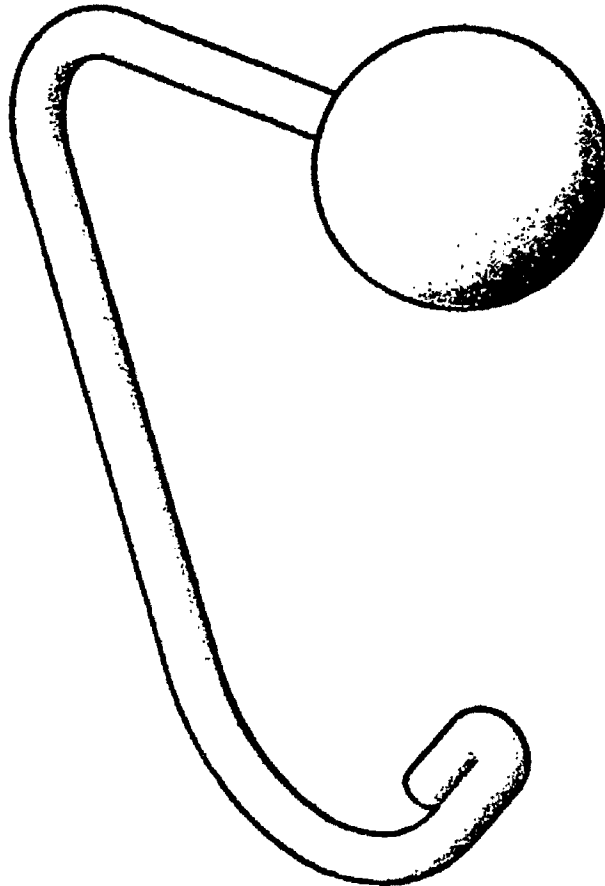

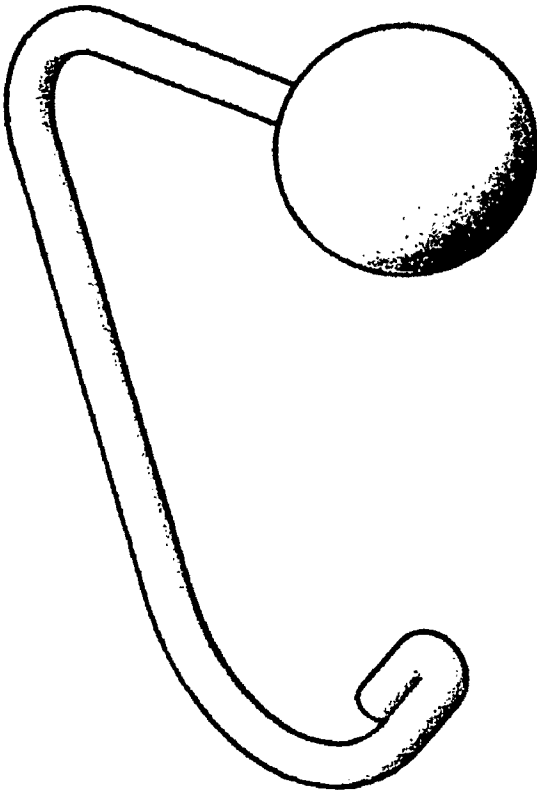

Fig 1

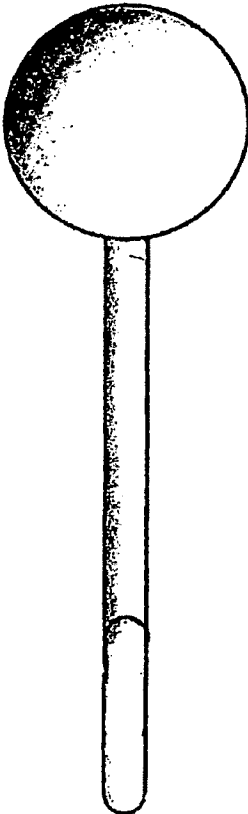

Fig 2

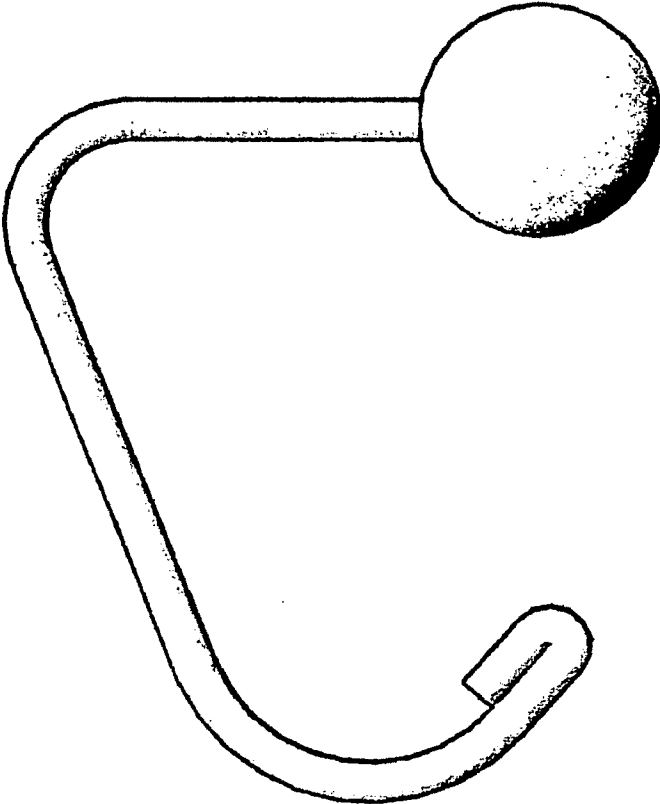

Fig 3

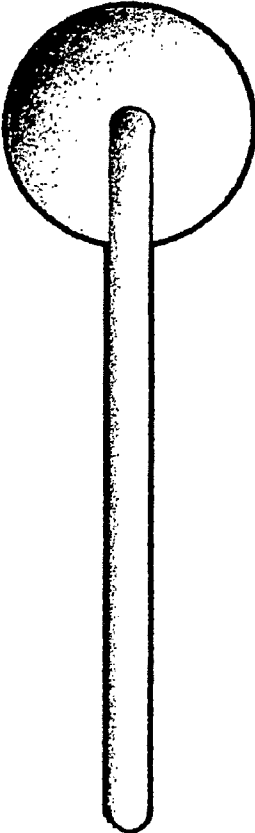

Fig 4

EXHIBIT C
Mesiti Declaration
U.S. Design Patent No. D560,924



US00D560924S

(12) **United States Design Patent**
Walker

(10) **Patent No.:** **US D560,924 S**

(45) **Date of Patent:** **** Feb. 5, 2008**

(54) **COMBINATION SHOWER CURTAIN HOOK AND PICTURE FRAME**

(75) Inventor: **David Lamont Walker**, Chester, PA (US)

(73) Assignee: **Zenith Products Corp.**, New Castle, DE (US)

(**) Term: **14 Years**

(21) Appl. No.: **29/247,257**

(22) Filed: **Jun. 8, 2006**

(51) **LOC (8) CL.** **06-04**

(52) **U.S. CL.** **D6/396; D6/300; D8/367**

(58) **Field of Classification Search** **D6/300-314, D6/315, 323, 328, 580, 370, 397; D8/367, D8/349; 211/13.1, 85.3, 86.01, 183; 160/39, 160/330; 248/339, 301, 304, 214-215; D3/210; 16/87.2; 40/700, 725, 717**
See application file for complete search history.

(56) **References Cited**

U.S. PATENT DOCUMENTS

267,938 A	11/1882	Rings	
396,604 A	1/1889	Rings	
397,419 A	2/1889	Day	
400,348 A	3/1889	Lawrence	
460,793 A	10/1891	Rings	
578,424 A	3/1897	Rings	
659,534 A	10/1900	Kroder	
686,124 A	11/1901	Parker	
699,507 A	5/1902	Erich	
805,919 A	11/1905	Kroder	
913,261 A	2/1909	Clark	
1,020,776 A	3/1912	Parry	
1,224,624 A	5/1917	Fjellman	
1,857,293 A	5/1932	Vroom	
2,320,003 A	5/1943	Madan	
3,223,373 A *	12/1965	Molinaro	248/339
3,315,297 A	4/1967	Bender	
4,887,785 A *	12/1989	Blaich	248/339
4,979,712 A	12/1990	Rios	

D350,279 S	9/1994	Tate	
5,575,446 A *	11/1996	Swenson et al.	248/304
D398,516 S *	9/1998	Brown et al.	D8/370
D400,425 S *	11/1998	Goodman et al.	D8/367
D428,802 S *	8/2000	Villano et al.	D8/367
D439,144 S	3/2001	Ho	
D441,584 S	5/2001	Ho	
D456,696 S	5/2002	Samelson	
D459,201 S	6/2002	Michaelson	
D469,682 S *	2/2003	Gary et al.	D8/367
6,530,120 B2	3/2003	Samelson	
D485,431 S *	1/2004	Hsu	D3/210
D489,249 S *	5/2004	Moore	D8/367
D495,242 S *	8/2004	Kucera et al.	D8/367
D496,849 S *	10/2004	Abdi et al.	D8/367
D505,315 S *	5/2005	Snell	D8/367
D505,614 S *	5/2005	Barrese	D8/367
D515,912 S *	2/2006	Snell	D8/367
D535,110 S *	1/2007	Hoernig	D6/323

* cited by examiner

Primary Examiner—Caron D. Veynar

Assistant Examiner—Sydney R Buffalow

(74) *Attorney, Agent, or Firm*—Akin Gump Strauss Hauer & Feld LLP

(57) **CLAIM**

The ornamental design for a combination shower curtain hook and picture frame, as shown and described.

DESCRIPTION

FIG. 1 is a front perspective view of a combination shower curtain hook and picture frame in accordance with my new design;

FIG. 2 is a front elevational view thereof;

FIG. 3 is a rear elevational view thereof;

FIG. 4 is a left side elevational view thereof;

FIG. 5 is a right side elevational view thereof;

FIG. 6 is a top plan view thereof; and,

FIG. 7 is a bottom plan view thereof.

1 Claim, 4 Drawing Sheets

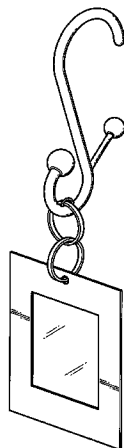

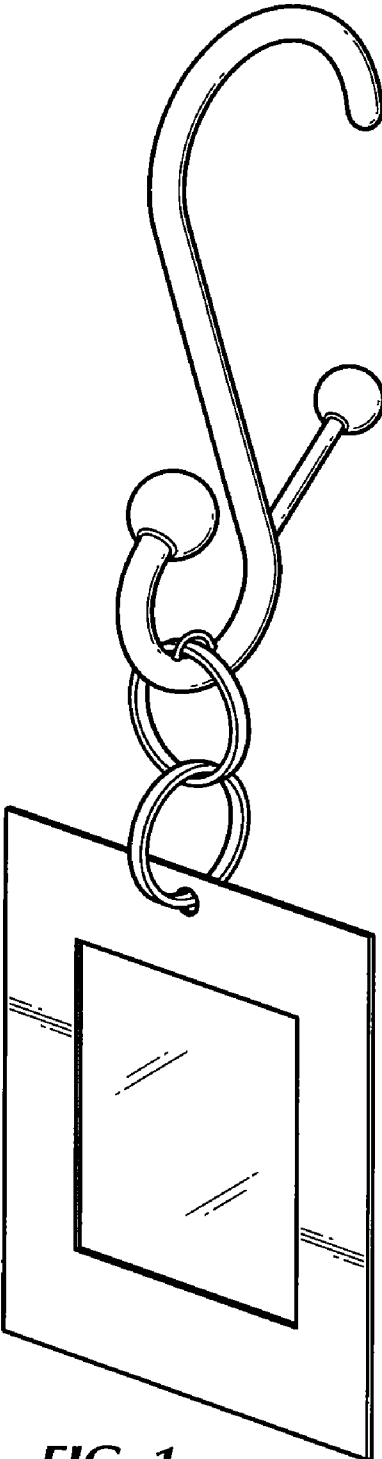

FIG. 1

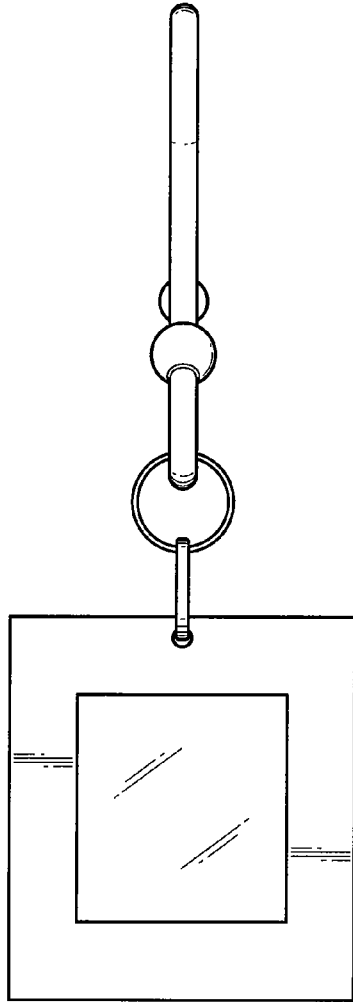

FIG. 2

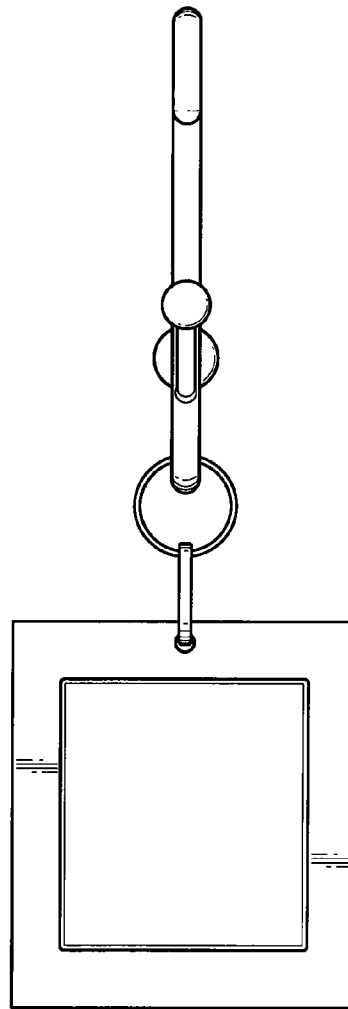

FIG. 3

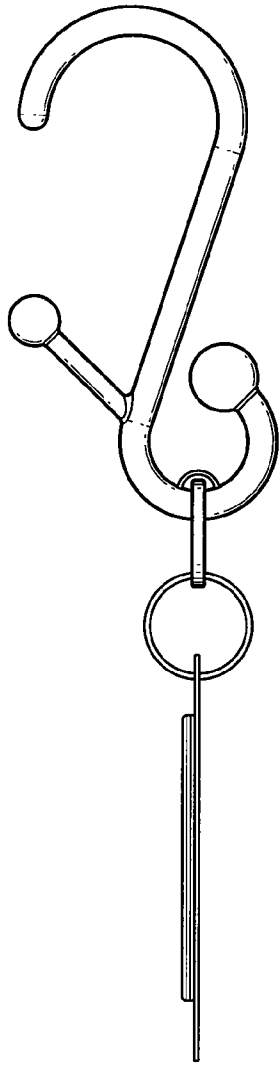

FIG. 4

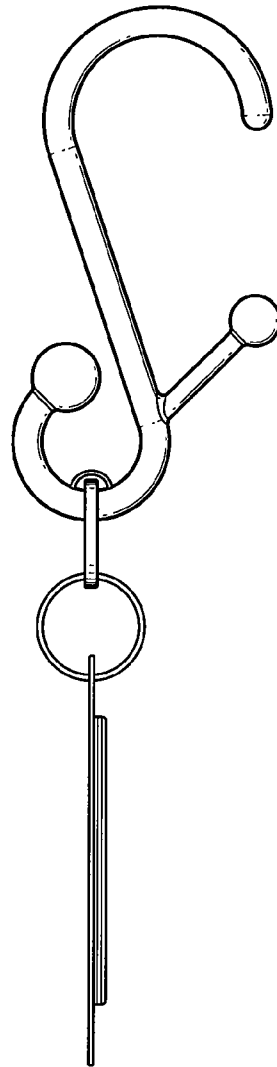

FIG. 5

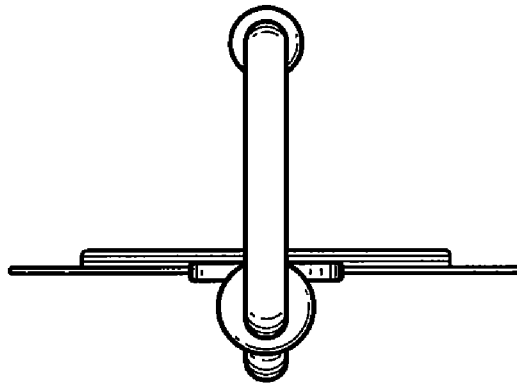

FIG. 6

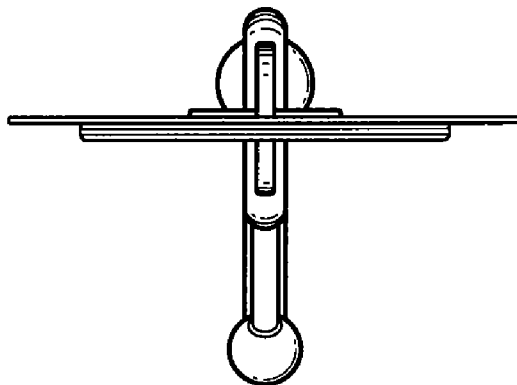

FIG. 7

EXHIBIT D
Mesiti Declaration
U.S. Patent No. 5,575,446



US005575446A

United States Patent [19]

[11] Patent Number: **5,575,446**

Swenson et al.

[45] Date of Patent: **Nov. 19, 1996**

[54] **CLAMPING DEVICE FOR SECURING CHRISTMAS TREE LIGHT WIRES AND/OR DECORATIONS TO CHRISTMAS TREES**

OTHER PUBLICATIONS

Instructions from package back for Lites Up Gutter Hook made by Gary Products Group, Lubbock, Texas. (no date supplied).

[75] Inventors: **Barbara Swenson**, P.O. Box 680096, Park City, Utah 84068; **D. Scott Beckham**, Summit County, Utah

Instructions from package back for Lites Up Ornament Hanger made by Gary Products Group, Lubbock, Texas (no date supplied).

[73] Assignee: **Barbara Swenson**, Sandy, Utah

Primary Examiner—Ramon O. Ramirez
Assistant Examiner—Michael J. Turgeon
Attorney, Agent, or Firm—Mallinckrodt & Mallinckrodt

[21] Appl. No.: **371,266**

[22] Filed: **Dec. 23, 1994**

[57] ABSTRACT

[51] Int. Cl.⁶ **F16B 45/00**

[52] U.S. Cl. **248/304; 248/306; 248/340**

[58] Field of Search 248/304, 303, 248/306, 340

A device for clamping the wires of a string of decorative lights to Christmas tree branches is formed of a wholly integral length of flexible, but normally shape-retaining material doubled back on itself from opposite ends thereof at opposite sides of a diagonally oriented, substantially central part of the length of material to provide oppositely directed, open loop clamping portions whose openings are at respective opposite sides of but at the central part of the length of material. The flexible material is such that an opening to an open loop can expand to accept branches to be received and held in a clamping loop along with light string wires and can be rotated to open the opening when release of a branch is desired. A loop of the device is selected for clamping to a branch leaving the other loop to serve as a handle for manipulating the device and thereafter free for receiving a Christmas tree decoration.

[56] References Cited

U.S. PATENT DOCUMENTS

3,277,291	10/1966	Holbrook	240/10
3,488,025	1/1970	Rowland	248/304
3,582,641	6/1971	Choquette	240/10
3,870,206	3/1975	Feinberg	248/340
3,977,050	8/1976	Perez	24/150
4,209,945	7/1980	Dent et al.	47/84
4,285,072	8/1981	Morcher et al.	3/13
4,775,310	10/1988	Fischer	425/308
4,887,785	12/1989	Blaich	248/304
4,966,344	10/1990	Gary	248/317
4,979,714	12/1990	Russell et al.	248/303
5,103,380	4/1992	Lindner et al.	362/32

15 Claims, 2 Drawing Sheets

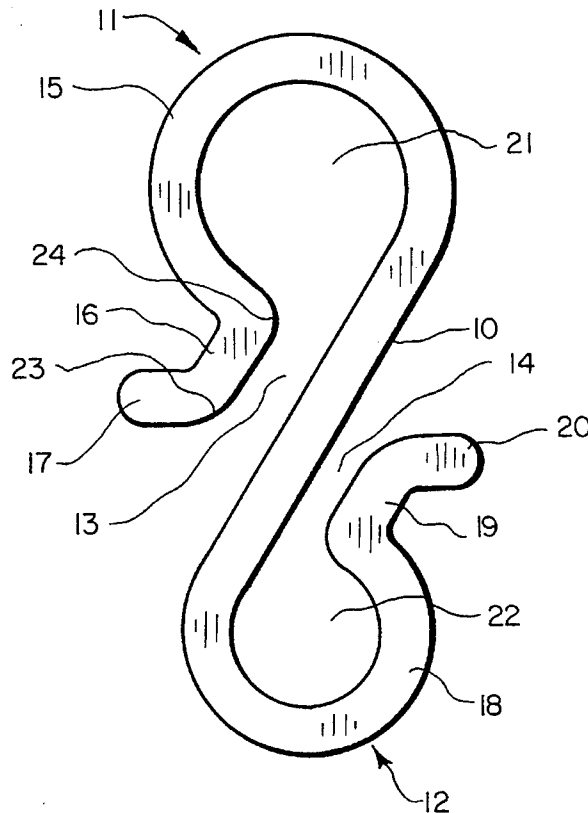

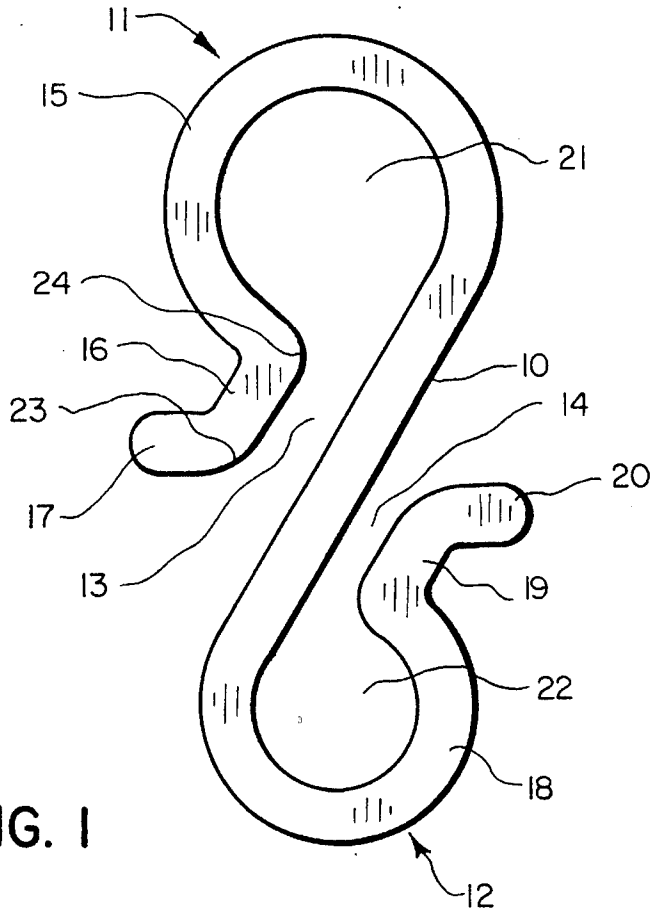

FIG. 1

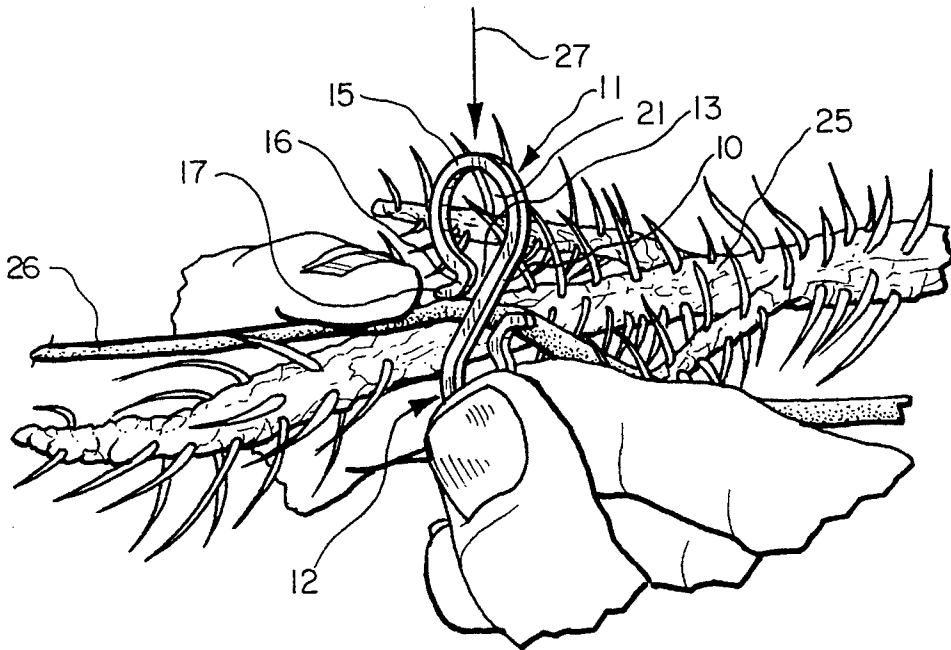

FIG. 2

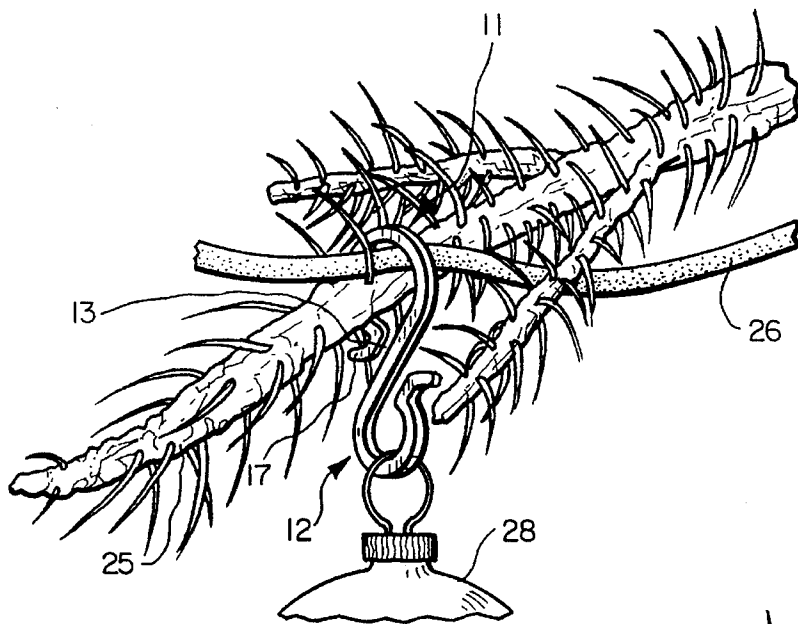

FIG. 3

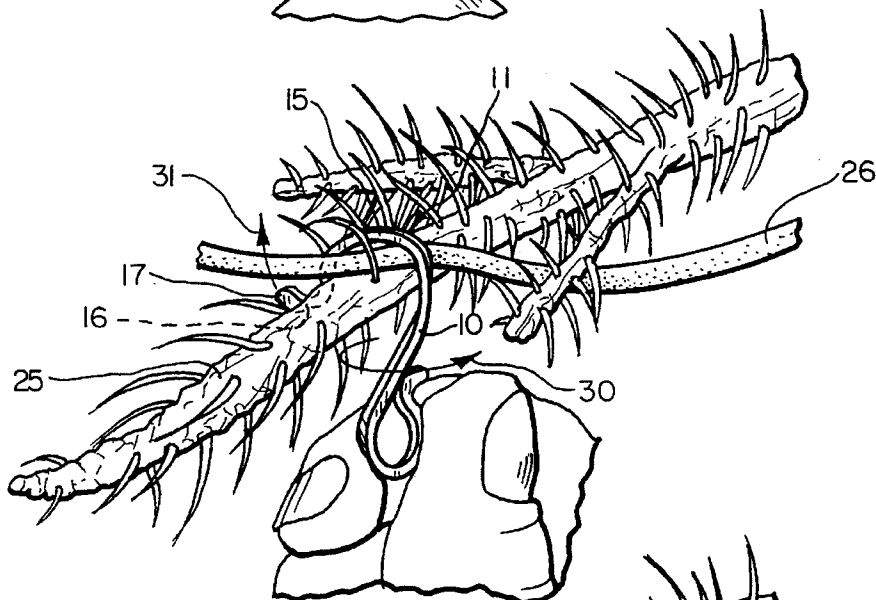

FIG. 4

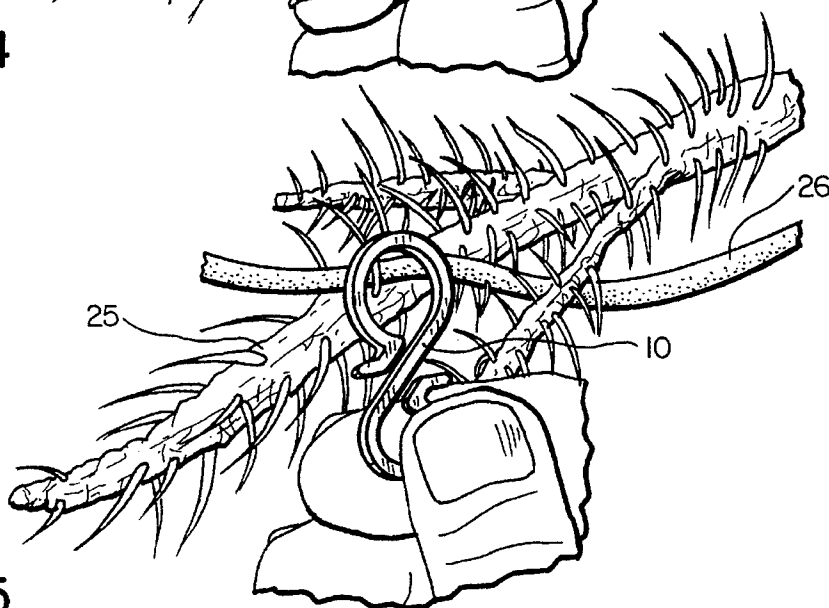

FIG. 5

1

CLAMPING DEVICE FOR SECURING CHRISTMAS TREE LIGHT WIRES AND/OR DECORATIONS TO CHRISTMAS TREES

BACKGROUND OF THE INVENTION

1. Field

The invention is in the field of securing Christmas tree lights, garlands, and ornaments to a Christmas tree.

2. State of the Art

Current practice in decorating Christmas trees is generally to drape the wires which connect Christmas tree light sockets with light bulbs therein from branch to branch of the tree to spread the lights around the tree. Generally the wires are not secured to the tree branches. In many instances this means that the wires can slip from the branches, and in some instances, it is difficult to extend the lights in a desired fashion between relatively widely spaced branches. With some light sets, loops in the wire at each light socket are provided with a slide bead over the wires so the loop can be placed about the end of a branch and the slide bead moved to close the loop around the branch to secure the light sockets to desired branches. Other light sockets are provided with clips of some type to enable the light socket to be clipped to a Christmas tree branch. However, the loops and clips generally are provided with relatively large light sockets, and the miniature light sets which have become popular generally do not include any means for securing a light socket to a branch. For some currently available light sets where an upright orientation of the light is important, such as lights which simulate candles, the light socket has a hand-operated spring clip on the bottom of the light socket so the light socket can be clipped to a branch in an upright position.

Similarly to strings of lights, tinsel garlands are generally draped from branch to branch with no means of securing the garland to a branch to hold it from sliding off.

SUMMARY OF THE INVENTION

According to the invention, a device for clamping the wires of a string of decorative lights to Christmas tree branches is formed of a wholly integral length of flexible, but normally shape-retaining material, that is doubled back on itself from opposite ends thereof at opposite sides of a diagonally oriented, substantially central part of the length of material to provide oppositely directed, open loop clamping portions whose openings are at respective opposite sides of but at the central part of the length of material. The clamping loops are generally of different sizes and either of the clamping loops may be selected for clamping a wire of a string of Christmas tree lights to a limb or branch of a Christmas tree. Selection is generally based on the size of the branch to which the device is applied. The other loop provides a handle for manipulating the device and, when in place on a branch, is free for receiving a Christmas tree ornament or other decoration, if desired. Such other loop could, if desired, receive the wire of the decorative light set or could receive a loop of a second device of the invention if additional length is required. The flexible material from which the device is made allows entry of a tree branch into a clamping loop and allows the device to be twisted so that, when desired, a loop thereof can be easily twisted and removed from a branch.

The diagonally oriented, substantially central part of the length of material forms a substantially straight central portion from the ends of which extend the open loop

2

clamping portions. These open loop clamping portions include arcuate portions which extend through at least approximately 270° from the ends of the central portion to double back on the central portion and the arcuate portions flow into relatively short straight portions which extend, preferably substantially parallel to the straight central portion and preferably spaced somewhat from the central portion, to provide openings leading into substantially circular areas formed by the arcuate portions. The relatively short straight portions terminate in end portions which extend at angles outwardly from the central portion to act as guides to the openings between the relatively short portions and the central portion. The transitions between the relatively short straight portion and the end portion are preferably of a relatively large radius compared to the radius of the transitions between the arcuate portions and the relatively short straight portions. This makes it easier to slide the device onto a branch than to slide it off of a branch.

THE DRAWINGS

The best mode presently contemplated for carrying out the invention is illustrated in the accompanying drawings, in which:

FIG. 1 is a side elevation of a device of the invention;

FIG. 2, a perspective view of the device being applied to a Christmas tree branch and decorative light set wire to hold the wire in position on the branch;

FIG. 3, a perspective view similar to that of FIG. 2, showing the device installed on the branch;

FIG. 4, a perspective view similar to that of FIG. 2, but showing the device twisted as it is prepared for removal from the branch; and

FIG. 5, a perspective view similar to that of FIG. 2, but show the device as removed from the branch.

DETAILED DESCRIPTION OF THE ILLUSTRATED EMBODIMENTS

Referring to FIG. 1, the clip or clamping device of the invention is formed of a length of flexible, but normally shape-retaining, material that is doubled back on itself from opposite ends thereof at opposite sides of a diagonally oriented, substantially central part or portion 10 of the length to provide oppositely directed, open loop clamping portions 11 and 12, which open at passage 13 and 14, respectively, at respective opposite sides of central portion 10. Both open loop clamping portions 11 and 12 open along central portion 10.

The central portion 10 is elongate and substantially straight. At each end of the straight central portion 10 is an arcuate portion wherein the clip doubles back on itself to form the open loop elements at each end extending from the central portion 10 in opposite directions. Thus, arcuate portion 15 extends from one end of straight central portion 10, through at least approximately 270° to a relatively short straight portion 16, which preferably is substantially parallel to straight central portion 10, which extends from arcuate portion 15 toward the opposite end of central portion 10. The relatively short straight portion 16 smoothly joins an end portion 17 which extends at an angle outwardly away from the central portion 10. Arcuate portion 18 extends from the opposite end of straight central portion 10, through at least approximately 270° to a relatively short straight portion 19, again which is preferably substantially parallel to straight central portion 10, which extends toward the one end of

central portion 10. Relatively short straight portion 19 smoothly joins an end portion 20 which extends at an angle outwardly away from the central portion 10. Arcuate portions 15 and 18 extend from central portion 10 in opposite directions as do end portions 17 and 20. While the relatively short straight portions 16 and 19 could be immediately adjacent central portion 10, it is preferred that they be spaced a short distance from central portion 10 to form the openings or passages 13 between central portion 10 and relatively short straight portion 16, and passage 14 between central portion 10 and relatively short straight portion 19. Passage 13 leads to a substantially circular area 21 formed by arcuate portion 15 and passage 14 leads to substantially circular area 22 formed by arcuate portion 18.

It is important for operation of the device that it be made of a flexible material which is normally shape-retaining which will allow flexing of the open loop portions 11 or 12 to accept and receive branches of a Christmas tree therein. Thus, the arcuate portions 15 or 18 will flex so that the relatively short straight portions 16 or 19 move outwardly whereby the passages 13 or 14 leading to the circular areas 21 or 22 can be enlarged to the normal diameter of the circular areas 21 or 22. This allows passage of a Christmas tree branch into the circular area 21 or 22. The material must also be such that it will return to its original configuration after such flexing so that the arcuate portions 15 or 18 will surround more than one-half of a received branch through the extent of the arc and hold the device on the branch. Polyolefins such as polypropylene and polyethylene have been found to be satisfactory materials. Himont 1050 polypropylene works well.

Each of the open loop portion 11 and 12 will preferably be of different size, i.e., the radius of each of the arcuate portions 15 and 18 will be different, whereby a larger loop can be used for a larger branch and a smaller loop can be used for a smaller branch. However, the loops could be of substantially equal size if desired for particular applications.

As can be seen in FIG. 1, the transition 23 along passage 13 from end portion 17 to relatively short straight portion 16 is smoothly radiused as is the transition 24 from arcuate portion 15 to relatively short straight portion 16. The radius of curvature for transition 23 is relatively large compared to the radius of curvature for transition 24. It is presently preferred that the radius of transition 23 be about double the radius of transition 24. The result of this difference is that it is easier for a branch to cam passage 13 open so the branch can move into circular area 21 than it is for a branch in circular area 21 to cam passage 13 open so that it can move out of circular 21. This is desirable so that it is easy to pull the device over a branch to thereby secure the device to a branch, but so that it is difficult, when once secured, for the branch to come out of the device. This tends to prevent unwanted release of the device from the branch. It is preferred that if a tangent be drawn to the midpoint of the transition, that for transition 23, it intersects the central portion 10 at an angle of between 30° and 45° and that for transition 24 it intersect the central portion 10 at an angle of between 60° and 80°. The transitions for the smaller open loop portion 12 will preferably be substantially the same as for the larger open loop portion 11.

For general indoor Christmas tree use, it is preferred that the clamping device of the invention be as unobtrusive or unnoticeable as possible. It is therefore preferred that the device be sized so that it fits within and does not extend beyond the needles extending from an average fir tree branch. It has been determined that generally an overall device length of about one and one-quarter inch meets this

requirement. With such length, the width of the device will be about five-eighths inch. The arcuate portion 15 of the larger open loop portion 11 has a radius of about 0.187 inch and the arcuate portion 18 of the smaller open loop portion 12 has a radius of about 0.125 inch. The radius of the transition 23 from the end portion 17 to the relatively short straight portion 16 is about 0.125 inch while the radius of the transition 24 from the arcuate portion 15 to the relatively short straight portion 16 is about 0.063 inch. The device is made of a length of polypropylene of rectangular cross section with a thickness of about 0.09 inch and a width of about 0.125 inch. Larger passage 13 is about 0.09 inch in width, about the same size as the thickness of the material from which the device is made, and the smaller passage 14 is about two-thirds the size of the larger passage at about 0.06 inch. The lengths of the two relatively short straight portions 16 and 19 are equal and are about 0.09 inches, equal to the width of the larger passage 13. End portions 17 and 20 extend outwardly at an angle of about 60° from the central portion 10.

The above measurements are currently preferred for indoor Christmas tree use, however, it should be realized that the device of the invention could be made in various sizes and, particularly, could be made in a larger size for use with large outdoor trees whose branches are generally larger than indoor Christmas trees.

In use, a user selects the particular open loop portion 11 or 12 to be used with and receive a particular branch, such as loop 11 in FIGS. 2-5, and holds the other open loop portion, 12 in FIGS. 2-5, as a handle to manipulate the device. The entrance to open loop portion 11, formed by end portion 17 leading to passage 13 is positioned adjacent a selected branch 25. If the device is being used to secure a wire 26 of a decorative light set in one of the securement arrangements of the invention, the wire 26 is placed over the branch as shown in FIG. 2 and the entrance to open loop portion 11 is positioned at the intersection of the branch and wire. The device is pulled against the branch in the direction of arrow 27. The loop will flex to enlarge passage 13 so that branch 25 will pass through passage 13 as the device is moved in the direction of the arrow 27 and pass into circular area 21. Open loop portion 11 will close around branch 25 to secure the device to the branch as shown in FIG. 3. Wire 26 is then held in place on branch 25 as shown in FIG. 3. With the current arrangement of the end portion 17 and transition 23 therefrom to relatively short straight portion 16, the device slips easily onto branch 25. With the described arrangement of the transition 24 from the arcuate portion 15 to relative short straight portion 16, it is difficult to slide the device from branch 25. A branch 25 does not have to completely fill circular area 21 for the device to be secured thereto. The branch 25 merely need be larger than passage 13 so that it does not easily pass back through the passage to release the device. Thus, the device will clamp a wire to the branch and hold it in position and will stay on the branch even when loose about the branch.

With the device of the invention secured to branch 25 as shown in FIG. 3, open loop portion 12 is available to receive and hang an ornament 28. Alternately, light string wire 26, rather than being held in place over branch 25 by open loop portion 11 around branch 25, could be positioned in and held in place by open loop portion 12. Tinsel and other garlands could be secured and held to branch 25 in the same manner as wire 26. Further, if a light wire, garland, ornament, or other item is to be supported in position at a greater distance below branch 25, one or more additional devices could be used, one hung from the other end-to-end, to support such item at any desired distance from the branch.

5

When it is desired to remove the device from the branch 25, a user could, using the entrance to passage 13 formed by end portion 17, flex open loop portion 11 to open passage 13 to allow the device to be removed from branch 25. A preferred method of removal, because it is generally easier, is to grasp the device and twist it as shown by arrow 30 in FIG. 4 to flex open loop portion 11 and straight central portion 10 so that the end of the loop formed by relatively short straight portion 16 and end portion 17 are rotated approximately 90° from their original positions to thereby open passage 13 as shown in FIG. 4, and while in that position, the device is moved upwardly in the direction of arrow 31 and removed from the branch 25. After removal, the material returns to its original configuration and the removed device is shown in FIG. 5.

While it is preferred that relatively short straight portions 16 and 19 extend parallel to central portion 10, this is not necessary and in some instances, particularly with the smaller loop, warpage during cooling of the device after molding may result in portion 19 extending at an angle to central relatively short straight portion 10.

While it is preferred that the branch on which the device is secured fits within the space normally formed by the arcuate portion, with the materials used and the configuration of the device as shown, even if the branch is somewhat bigger than the opening normally formed by the arcuate portion, the device will flex and effectively clamp and hold the branch.

Whereas this invention is here illustrated and described with reference an embodiment thereof presently contemplated as the best mode of carrying out such invention in actual practice, it is to be understood that various changes may be made in adapting the invention to different embodiments without departing from the broader inventive concepts disclosed herein and comprehended by the claims that follow.

We claim:

1. A device for clamping the wires of a string of Christmas tree lights to Christmas tree branches and at the same time providing for attachment of a tree decoration, comprising a wholly integral length of flexible but normally shape-retaining material that is doubled back on itself from opposite ends thereof at opposite sides of a diagonally oriented, substantially central part of said length to provide oppositely directed, open loop clamping portions whose openings are at respective opposite sides of but at said central part of said length, said openings formed by relatively short straight portions substantially parallel to the central part of said length, whereby either of said clamping loops may be selected for clamping of a wire of a string of Christmas tree lights to a branch of the Christmas tree, leaving the other free for receiving a Christmas tree decoration.

2. A device according to claim 1, wherein the flexible, normally shape-retaining material is a polyolefin.

3. A device according to claim 2, wherein the polyolefin is polypropylene.

4. A device according to claim 1, wherein the clamping loops are of different sizes so that selection of the clamping loop is based upon the size of the branch to which the wire is to be clamped.

5. A device for securing the wire of a decorative light string or an ornament to a Christmas tree comprising:

6

an elongate, substantially straight central portion having opposite ends;

a first arcuate portion extending in a direction from one end of the central portion through an arc of at least approximately 270° to a first arcuate portion end;

a first relatively short straight portion extending from the first arcuate portion end toward the opposite end of the substantially straight central portion, said first relatively short straight portion being substantially parallel with said substantially straight central portion and having a first relatively short portion end toward said opposite end;

a first end portion extending from the first relatively short portion end at an angle outwardly away from the central portion;

a second arcuate portion extending from the opposite end of the central portion in a direction opposite to the direction of the first arcuate portion through an arc of at least approximately 270° to a second arcuate portion end;

a second relatively short straight portion extending from the second arcuate portion end toward the one end of the substantially straight central portion, said second relatively short straight portion being substantially parallel with said substantially straight central portion and having a second relatively short portion end toward said one end; and

a second end portion extending from the second relatively short portion end at an angle outwardly away from the central portion;

all portions of said device being unitarily formed of a flexible, normally shape-retaining material to allow said first arcuate portion to bend to allow a tree branch to pass between the central portion and first relatively short straight portion to be received within a space within the first arcuate portion and to allow said first arcuate portion to be twisted sufficiently when desired to allow escape of a received tree branch from the space within the first arcuate portion.

6. A device according to claim 5, wherein the first and second relatively short straight portions are spaced from the central portion to provide an opening therebetween.

7. A device according to claim 5, wherein the flexible material allows the second arcuate portion to bend to allow a tree branch to pass between the central portion and the second relatively short straight portion to be received within a space within the second arcuate portion and to allow the second arcuate portion to be twisted sufficiently when desired to allow escape of a received tree branch from the space within the second arcuate portion.

8. A device according to claim 5, wherein each arcuate portion extends at a constant radius along its length.

9. A device according to claim 8, wherein the first arcuate portion has a first radius and the second arcuate portion has a second radius, and wherein the first and second radii are different, whereby the space within one arcuate portion is larger than the space within the other arcuate portion so that larger branches may be received within the larger space.

10. A device according to claim 5, including a smooth arcuate transition of substantially constant radius from the first end portion to the first relatively short portion and a smooth arcuate transition of substantially constant radius from the first arcuate portion to the first relatively short portion, wherein the radius of the transition from the first

7

end portion to the first relatively short portion is larger than the radius of the transition from the first arcuate portion to the first relatively short portion, whereby it is easier to slide the device onto a branch than it is to slide the device off of a branch.

11. A device according to claim 10, wherein the larger radius is about twice the smaller radius.

12. A device according to claim 10, including a smooth arcuate transition of substantially constant radius from the second end portion to the second relatively short portion and a smooth arcuate transition of substantially constant radius from the second arcuate portion to the second relatively short portion, wherein the radius of the transition from the

8

second end portion to the second relatively short portion is larger than the radius of the transition from the second arcuate portion to the second relatively short portion, whereby it is easier to slide the device onto a branch than it is to slide the device off of a branch.

13. A device according to claim 12, wherein the larger radius is about twice the smaller radius.

14. A device according to claim 5, wherein the flexible, normally shape-retaining material is a polyolefin.

15. device according to claim 14, wherein the polyolefin is polypropylene.

* * * * *

EXHIBIT G
Mesiti Declaration
Design Patent No. D475,278

(12) United States Design Patent (10) **Patent No.:** **US D475,278 S**
Williams (45) **Date of Patent:** **** Jun. 3, 2003**

(54) **SOCK HOOK**

(75) Inventor: **Arnold H. Williams**, Boxborough, MA (US)

(73) Assignee: **Christmas Cove Designs, Inc.**, Richmond, ME (US)

(**) Term: **14 Years**

(21) Appl. No.: **29/161,139**

(22) Filed: **May 23, 2002**

(51) **LOC (7) Cl.** **08-05**

(52) **U.S. Cl.** **D8/367; D3/328**

(58) **Field of Search** **D8/373, 367, 368; 211/113, 86.01, 106.01, 13.1; D11/42, 126, 130; 248/214, 215, 302-308, 309.1, 339, 341, 914, 497; D3/328, 304; D6/315, 317**

(56) **References Cited**

U.S. PATENT DOCUMENTS

2,473,086	A	*	6/1949	Montero	248/308
2,521,037	A	*	9/1950	Brinton	211/85.3
D244,883	S	*	6/1977	Rohrmuller	D3/328
D295,267	S	*	4/1988	Saraga	D11/42
5,816,558	A	*	10/1998	Sommer et al.	248/544
D401,840	S	*	12/1998	Goodman et al.	D8/367

* cited by examiner

Primary Examiner—Pamela Burgess

(74) *Attorney, Agent, or Firm*—Pandiscio & Pandiscio

(57) **CLAIM**

The ornamental design for a sock hook, as shown and described.

DESCRIPTION

FIG. 1 is a perspective view of a sock hook showing my new design, the broken lines shown are for illustrative purposes only and form no part of the claimed design;

FIG. 2 is an enlarged perspective view of the sock hook shown in FIG. 1;

FIG. 3 is a right side elevational view of the sock hook shown in FIG. 1;

FIG. 4 is a left side elevational view of the sock hook shown in FIG. 1;

FIG. 5 is a top plan view of the sock hook shown in FIG. 1;

FIG. 6 is a bottom plan view of the sock hook shown in FIG. 1;

FIG. 7 is a front elevational view of the sock hook shown in FIG. 1;

FIG. 8 is a rear elevational view of the sock hook shown in FIG. 1;

FIG. 9 is a perspective view of a second embodiment of the sock hook showing my new design, the broken lines shown are for illustrative purposes only and form no part of the claimed design;

FIG. 10 is an enlarged perspective view of the sock hook shown in FIG. 9;

FIG. 11 is a right side elevational view of the sock hook shown in FIG. 9;

FIG. 12 is a left side elevational view of the sock hook shown in FIG. 9;

FIG. 13 is a top plan view of the sock hook shown in FIG. 9;

FIG. 14 is a bottom plan view of the sock hook shown in FIG. 9;

FIG. 15 is a front elevational view of the sock hook shown in FIG. 9; and,

FIG. 16 is a rear elevational view of the sock hook shown in FIG. 9.

1 Claim, 8 Drawing Sheets

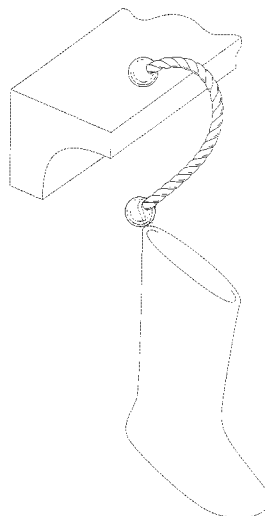

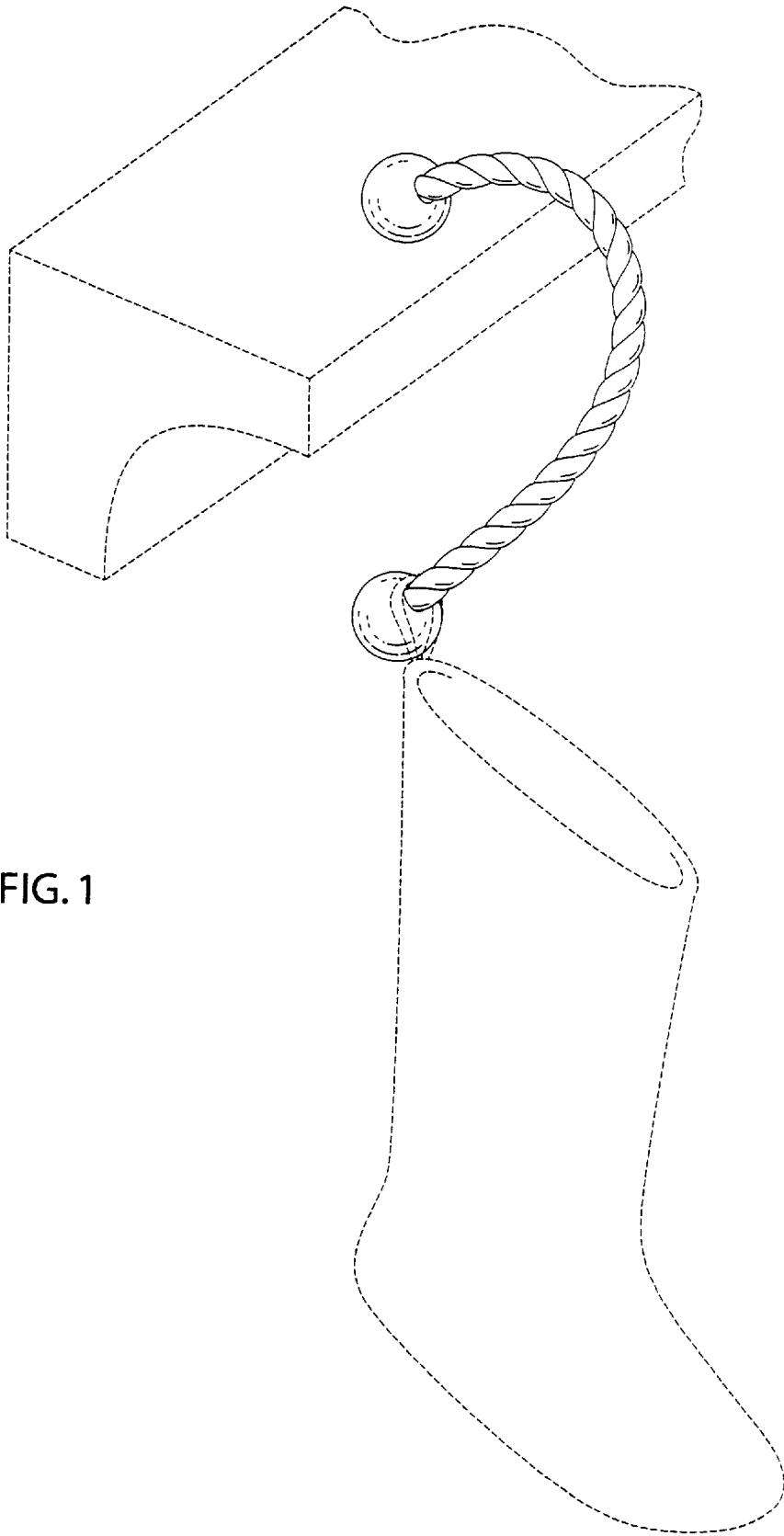

FIG. 1

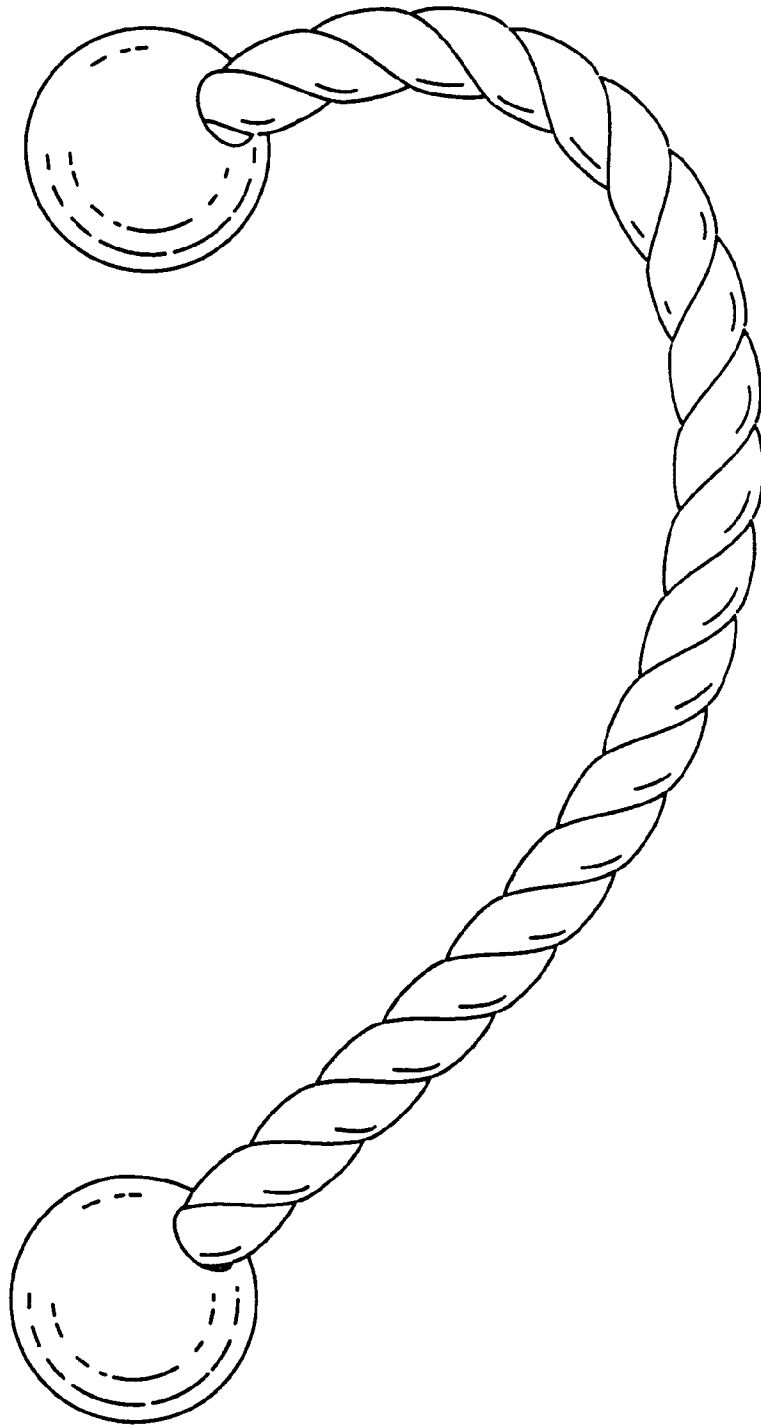

FIG. 2

FIG. 3

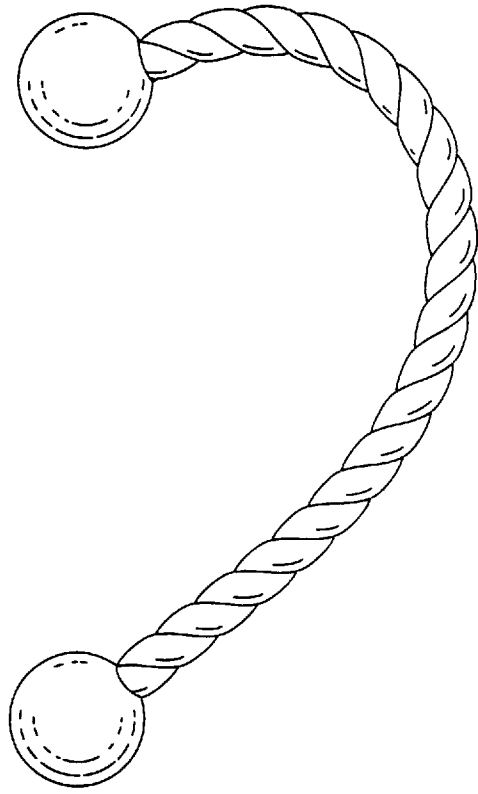
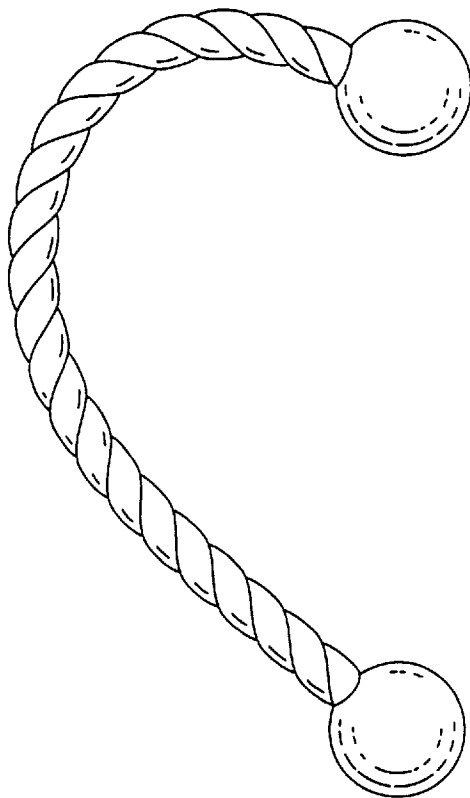

FIG. 4



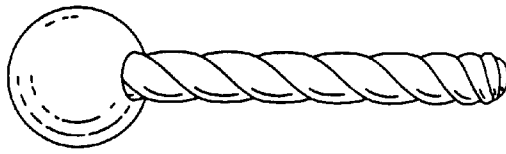

FIG. 5

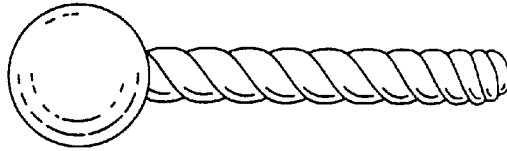

FIG. 6

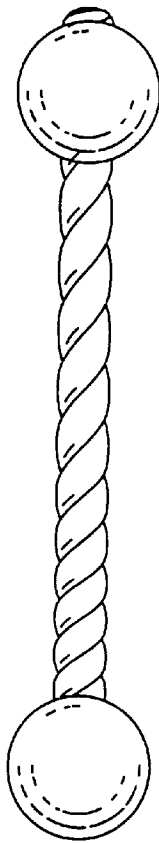

FIG. 7

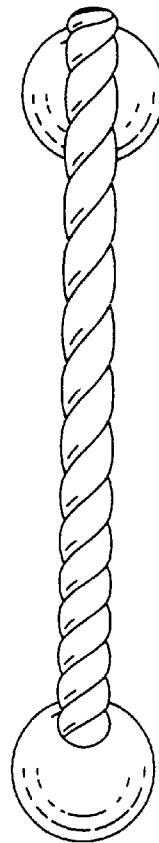

FIG. 8

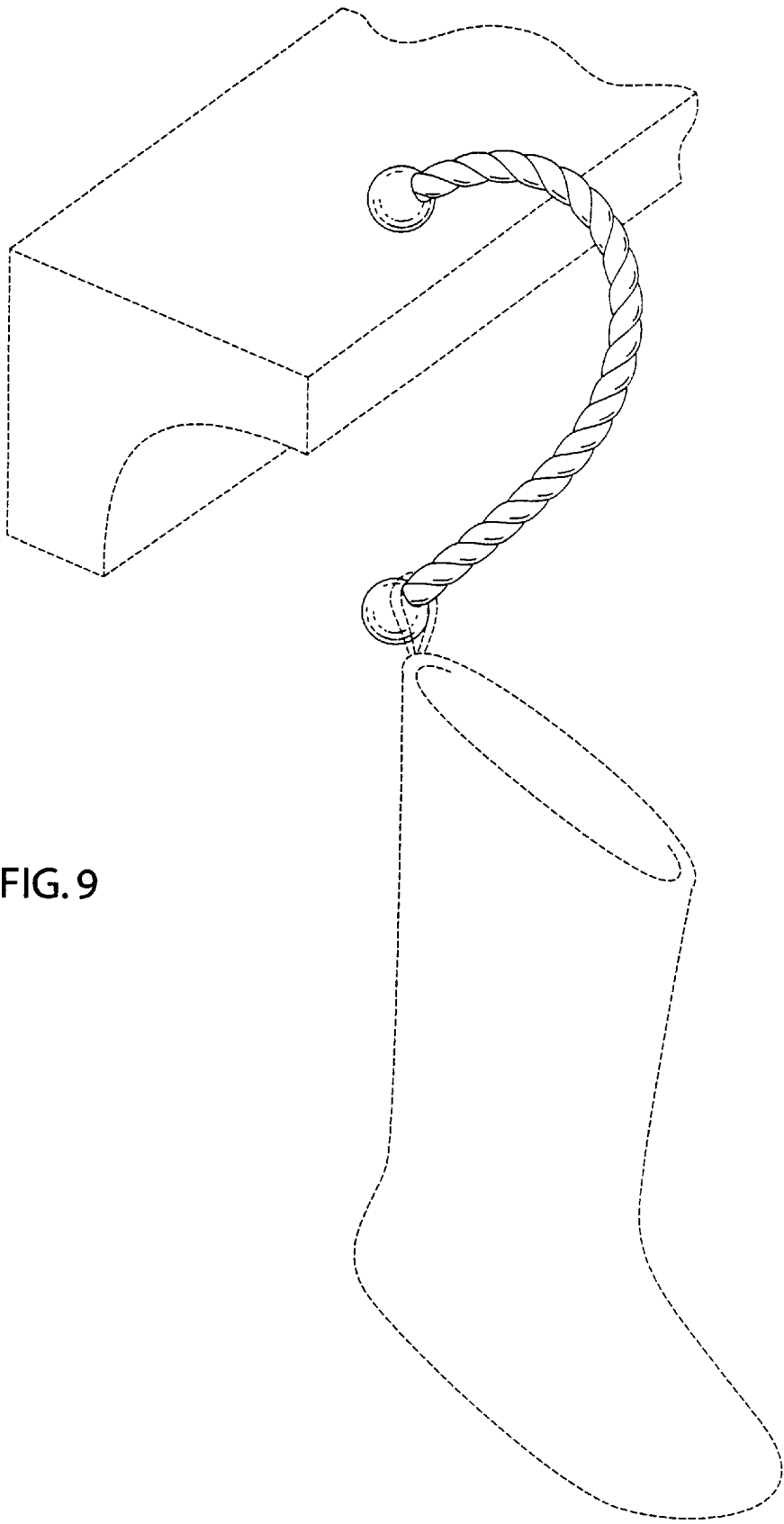

FIG. 9

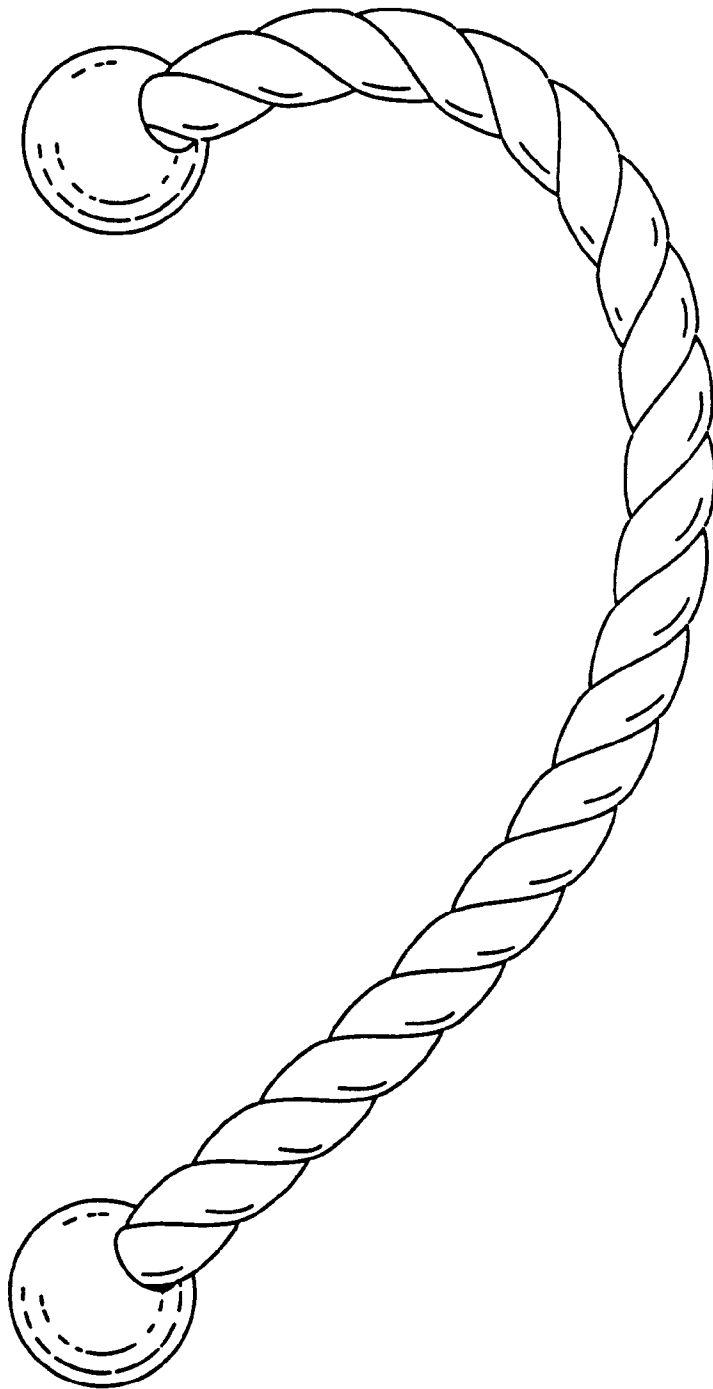

FIG. 10

FIG. 11

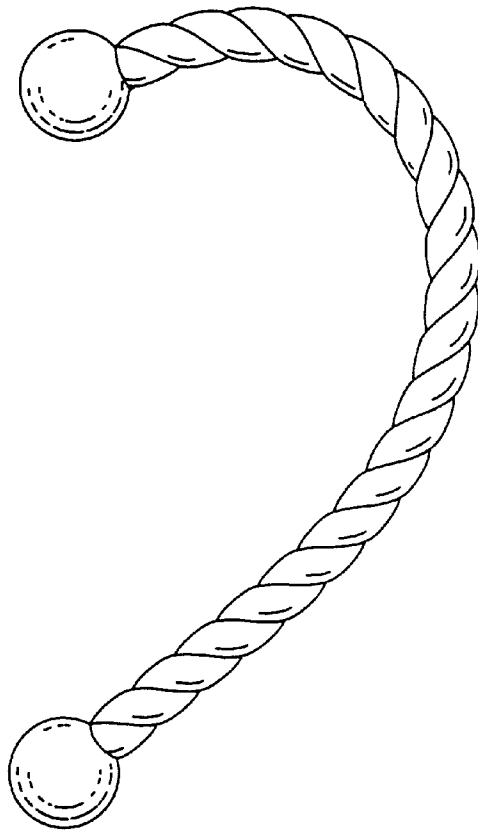
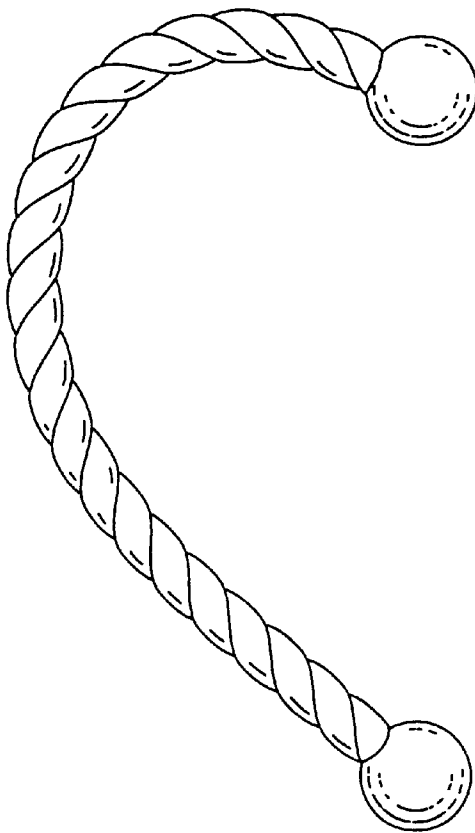

FIG. 12



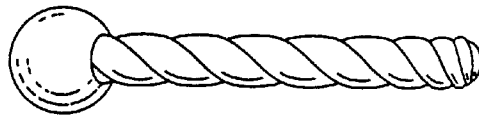

FIG. 13



FIG. 14

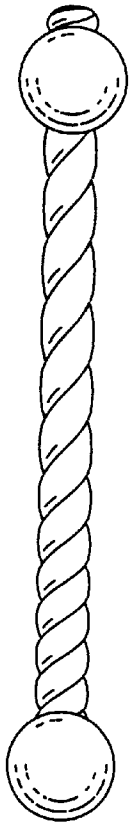

FIG. 15

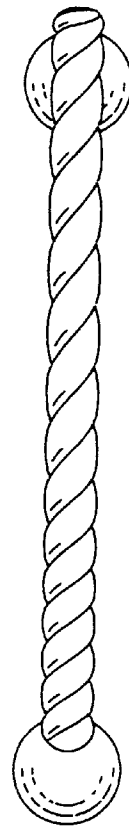

FIG. 16

EXHIBIT F
Mesiti Declaration
U.S. Design Patent No. D493,092



US00D493092S1

(12) **United States Design Patent**
Kalat

(10) **Patent No.:** **US D493,092 S**

(45) **Date of Patent:** **** Jul. 20, 2004**

(54) **SNAP-TYPE UTILITY HOOK**

(74) *Attorney, Agent, or Firm—Alix, Yale & Ristas, LLP*

(75) **Inventor:** **Edward W. Kalat**, Southington, CT (US)

(57) **CLAIM**

The snap-type utility hook, as shown and described.

(73) **Assignee:** **Southington Tool & Manufacturing Corporation**, Plantsville, CT (US)

DESCRIPTION

(**) **Term:** **14 Years**

(21) **Appl. No.:** **29/187,188**

(22) **Filed:** **Jul. 29, 2003**

(51) **LOC (7) Cl.** **08-05**

(52) **U.S. Cl.** **D8/367; D8/370**

(58) **Field of Search** **D8/367, 370; 248/302-303; 24/601.4, 298, 599.8, 599.9, 600.9, 265 R, 265 H**

FIG. 1 is a front view of a first embodiment snap-type utility hook showing my new design;
FIG. 2 is a left side view of the snap-type utility hook of FIG. 1;
FIG. 3 is a right side view of the snap-type utility hook of FIG. 1;
FIG. 4 is a rear view of the snap-type utility hook of FIG. 1;
FIG. 5 is a top plan view of the snap-type utility hook of FIG. 1;
FIG. 6 is a bottom plan view of the snap-type utility hook of FIG. 1;
FIG. 7 is a front view of a second embodiment of a snap-type utility hook showing the new design;
FIG. 8 is a left side view of the snap-type utility hook of FIG. 7;
FIG. 9 is a right side view of the snap-type utility hook of FIG. 7;
FIG. 10 is a rear view of the snap-type utility hook of FIG. 7;
FIG. 11 is a top plan view of the snap-type utility hook of FIG. 7;
FIG. 12 is a bottom plan view of the snap-type utility hook of FIG. 7;
FIG. 13 is a frontal perspective view of the snap-type utility hook of FIG. 7; and,
FIG. 14 is a rear perspective view of the snap-type utility hook of FIG. 1.

(56) **References Cited**

U.S. PATENT DOCUMENTS

25,082	A	*	8/1859	Pollack	24/600.9
437,380	A	*	9/1890	Lundborg	24/600.9
721,071	A	*	2/1903	McGill	248/302
804,273	A	*	11/1905	Smith	24/600.9
5,913,479	A	*	6/1999	Westwood, III	24/298
6,230,375	B1	*	5/2001	Catlett	24/599.8
6,427,296	B1	*	8/2002	Chang	24/601.4

OTHER PUBLICATIONS

I-FUJII Enterprise, Co. Ltd., p. 55, Aug. 15, 1995, hook located in middle of page.*

* cited by examiner

Primary Examiner—Holly Baynham

1 Claim, 3 Drawing Sheets

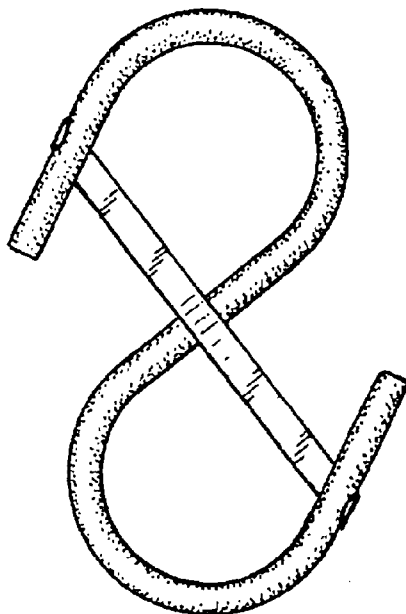



FIG. 5

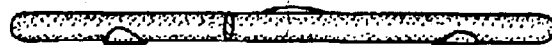

FIG. 2

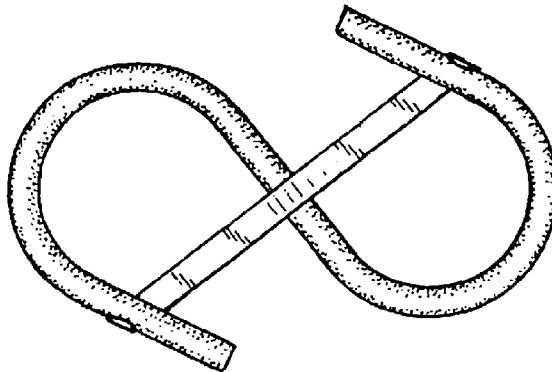

FIG. 1



FIG. 3

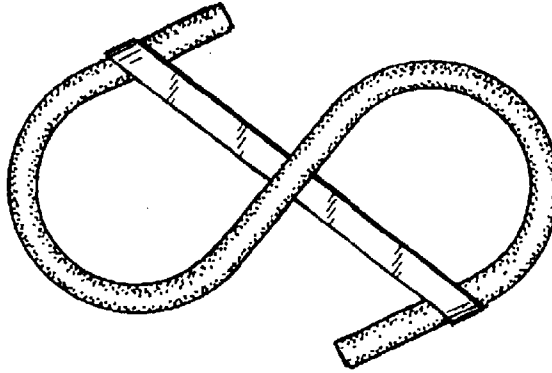

FIG. 4



FIG. 6

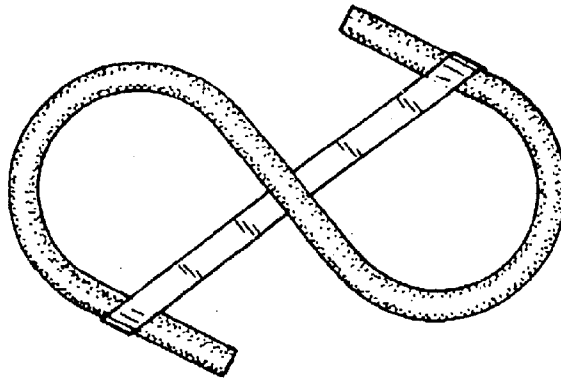

FIG. 10



FIG. 9



FIG. 11

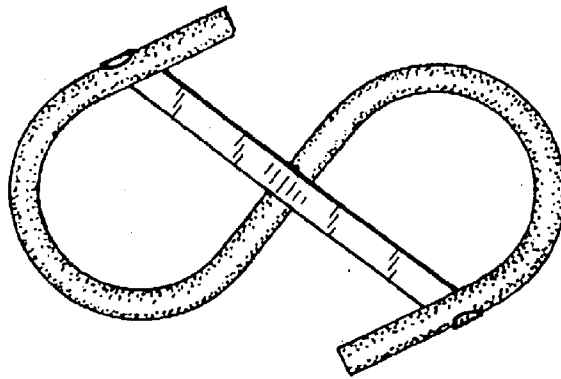

FIG. 7



FIG. 12



FIG. 8

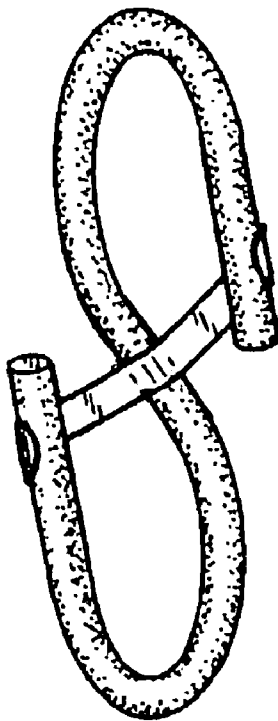

FIG. 13

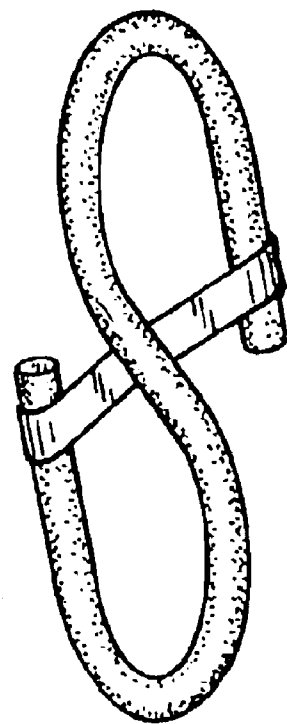

FIG. 14

EXHIBIT G
Mesi Declaration
U.S. Design Patent No. D644,438



US00D644438S

(12) **United States Design Patent**
Brucker

(10) **Patent No.:** **US D644,438 S**

(45) **Date of Patent:** **** Sep. 6, 2011**

(54) **HANGER FOR A PURSE OR THE LIKE**

(76) Inventor: **Lester A. Brucker**, Chokoloskee, FL (US)

(**) Term: **14 Years**

(21) Appl. No.: **29/364,377**

(22) Filed: **Jun. 23, 2010**

(51) **LOC (9) Cl.** **03-01**

(52) **U.S. Cl.** **D3/328**

(58) **Field of Classification Search** D3/328;

D8/367, 370; D6/323; 248/215, 302-303

See application file for complete search history.

(56) **References Cited**

U.S. PATENT DOCUMENTS

D229,870 S *	1/1974	Czarny	D3/328
D384,505 S *	10/1997	Stewart	D3/328
D400,425 S *	11/1998	Goodman et al.	D8/367
D408,723 S *	4/1999	Goodman et al.	D8/367
D429,899 S *	8/2000	Schwartz	D6/327
D435,733 S *	1/2001	Osterholt	D3/328

D465,653 S *	11/2002	Fuschillo	D3/328
D514,319 S *	2/2006	King et al.	D3/328
7,322,554 B2 *	1/2008	Caroselli et al.	248/304
D596,859 S *	7/2009	Castaline et al.	D3/328
D599,188 S *	9/2009	Ingalsbe et al.	D8/328
D611,330 S *	3/2010	Barrese	D8/367

* cited by examiner

Primary Examiner — Holly Baynham

(57) **CLAIM**

For the ornamental design of a hanger for a purse or the like, as shown and described.

DESCRIPTION

FIG. 1 is a perspective view of the hanger
FIG. 2 is a front elevation view
FIG. 3 is a left side elevation view, the right side being a mirror image; and,
FIG. 4 is a rear elevation view.

1 Claim, 4 Drawing Sheets

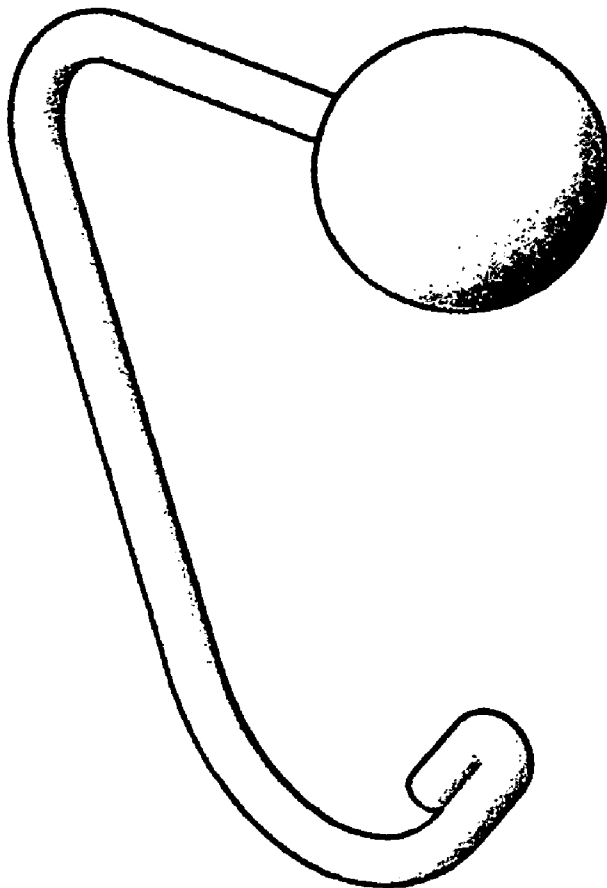

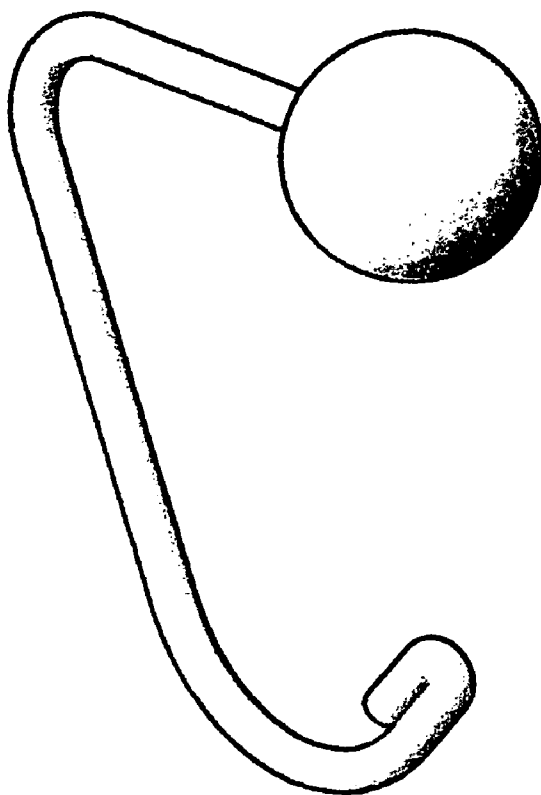

Fig 1

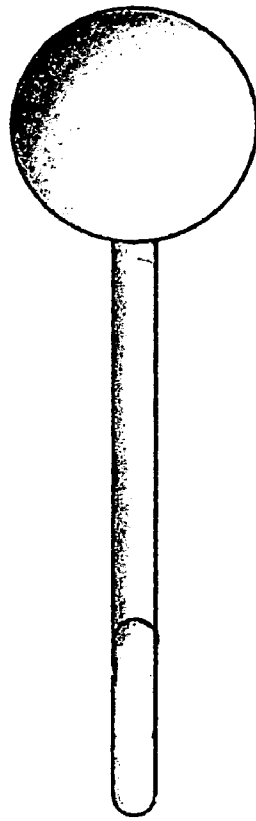

Fig 2

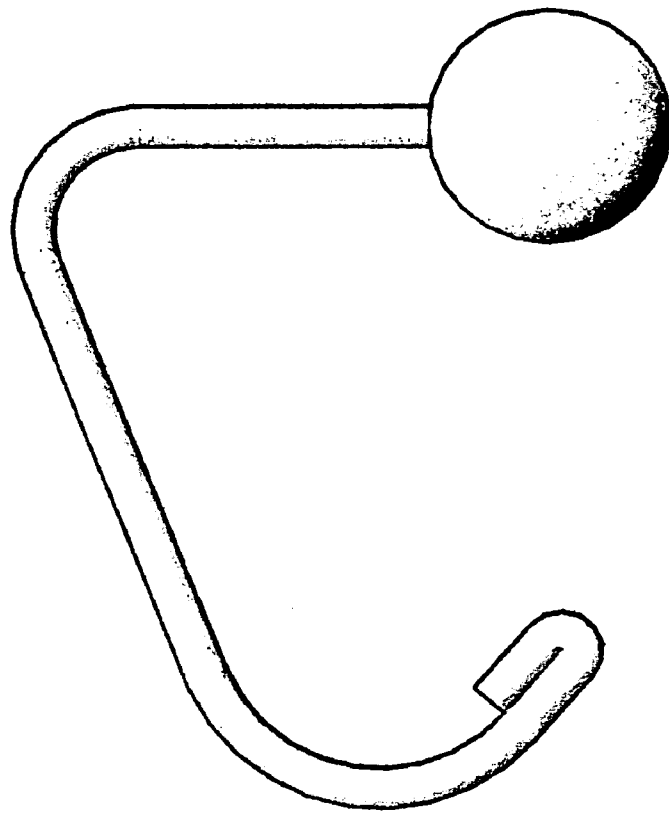

Fig 3

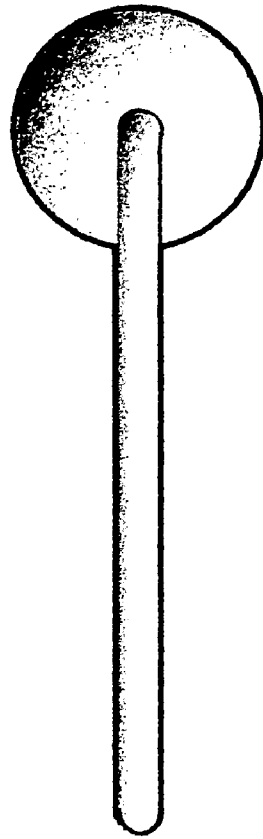

Fig 4

EXHIBIT H
Mesiti Declaration
Infringing Product Images Type 1



Front View



Back View



First Side



Second Side



Top



Bottom

EXHIBIT I
Mesiti Declaration
Infringing Product Images Type 2



Front View



Back View



First Side



Second Side



Top



Bottom

EXHIBIT J
Mesiti Declaration
Infringing Product Images Type 3



Front View



Back View



First Side



Second Side



Top



Bottom

EXHIBIT K
Mesiti Declaration
Infringing Product Images Type 4



Front View



Back View



First Side



Second Side



Top



Bottom

EXHIBIT L
Mesiti Declaration
Jacki Easlick Webpage

👉 Free shipping on orders over 100.00



JACKI EASLICK

🛒 0 items (\$0.00)

about ▾ best sellers sue sue sweet ▾ handbags accessories ▾ shoes ▾ apparel ▾ tote hanger subscription box ▾ press policies

Search...



Tote Hanger®

\$12.99

add to cart

FEATURED ON THE **HOME EDIT SHOW** ON NETFLIX!
Episode 1.

New York Handbag Designer Jacki Easlick invented the new Tote Hanger®. These premium hooks are especially engineered to hang your handbags with elegance and balance. It's a small metal hook that is designed to hang on any traditional clothing rod just like coat hangers.

Simply remove the contents of your handbag and hang your handbag on the hook. Made out of nickel and the size is 3-3/4"h x 2"w. 6 hooks per pack.

We own the patent and trademark. Please do not purchase from Amazon, they are knock off products not approved by our company.

The Tote Hangers are sold at The Container Stores, Lowes, ETSY and Wayfair.

type: tote hanger by: jacki easlick llc

Copyright © 2023 JackiEaslick | All prices in USD

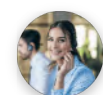

EXHIBIT M
Mesiti Declaration
Infringing Product Type 1 Webpages

First Webpage Showing Sale of Infringing
Product Type 1

Organize your space with GLUIT GLUIT Adhesive Hooks Heavy Duty 22 lbs Robe Towel Hooks Waterproof Adhesive Wall Hooks for Home Bathroom Kitchen Office and Outdoor 12 Pack \$12.99 prime

Home & Kitchen > Storage & Organization > Home Storage Hooks > Utility Hooks



CertBuy 20 Pack Purse Hanger for Closet, 4.5" Unique Twist Design Bag Hanger Purse Hooks, Closet Hooks for Hanging Handbags, Purses, Belts, Scarves, Hats, Clothes (Black)

Brand: CertBuy 4.0 rating

\$15.99

Get Fast, Free Shipping with Amazon Prime

FREE Returns

5 Best price

Get a \$60 gift card instantly: Pay \$0.00 \$45.99 upon approval for the Amazon Store Card. Find out how

Color	Black
Material	Metal
Brand	CertBuy
Item Dimensions LxWxH	4.5 x 1.7 x 1 inches
Mounting Type	Wall Mount

About this item

- 👉 **[Upgraded S hook]** : The new handbag hanger, twistable 90° for stability and sturdiness, making better use of vertical space to store your precious handbag and helping it retain its shape.
- 👉 **[Premium Quality]** : Our hanging purse hooks are made of iron and are resistant to deformation; the surface is wrapped in a soft coating that prevents the metal from scratching your belongings.
- 👉 **[Indoor Use]** : Use s hooks heavy duty to hang cookware in the kitchen, toiletries in the bathroom or easily hang handbags, rucksacks, belts, jeans, tops, scarves and more.
- 👉 **[Outdoors Use]** : Use s hooks to hang plants in the garden, organize gadgets in the garage, no assembly or perforation required, can be used with wall rails, shelves.
- 👉 **[You Will Receive]** : 20 pieces of purse hooks for closet, size 4.5 x 1.6 inch / 115 x 42 mm, very practical and able to hang anything in a limited space.

prime Enjoy fast, FREE delivery, exclusive deals and award-winning movies & TV shows with Prime Try Prime and start saving today with Fast, FREE Delivery

\$15.99 Get Fast, Free Shipping with Amazon Prime FREE Returns

FREE delivery Wednesday, November 22 on orders shipped by Amazon over \$35 Or fastest delivery Thursday, November 16. Order within 1 hr 19 mins

Delivering to Albany 12201 - Update location

In Stock Qty: 1 Add to Cart Buy Now Ships from Amazon Sold by CBtone Returns Returnable until Jan 31, 2024 Payment Secure transaction Add a gift receipt for easy returns Add to List



Infringing Product Type 1

RELBRO 30 Pack 3.7 Inch Black S Shaped Heavy Duty Metal Close...
 4.29 rating
 15% off Deal
 \$6.79 \$7.99 prime

30 Black S Shaped Hooks, by ESFUN...
 4.360 rating
 \$8.99 prime

Buy it with

This item: CertBuy 20 Pack Purse Hanger for Closet, 4.5" Unique Twist Design Bag Hanger Purse... \$15.99

+ EZifego Double Sided Tape Heavy Duty, Extra Large Nano Double Sided Adhesive Tape, Clear... \$9.99 (\$0.08/Item)

+ DOKU Over The Door Hook, Stainless Steel Heavy Duty Over Door Hanger Holder for Coat Ro... \$12.99

Total price: \$38.96 Add all 3 to Cart

These items are shipped from and sold by different sellers. Show details

4 stars and above

Purse Hanger Purse Organizer for Closet, S Hooks Twist Design Bag Hanger, Closet Rod... \$8.98 (\$1.12/Count) prime

Amber Home 20 Pack 6" Metal Boots Hangers with 2 Adjustable Clips, Portable Multifu... \$19.99 (\$1.00/Count) prime

Mzekgam 10 Pack Purse Hanger for Closet, Unique Twist Design Closet Organizer... \$11.99 (\$1.20/Count) prime

ZEDODIER 14 Pack Purse Hooks for Closet, Backpack Hanger Bag Holder, Closet Access... \$7.99 (\$0.57/Count) prime

12 Pack Purse Hanger for Closet, Unique Twist Design Bag Hanger Purse Hooks, Large S... \$9.69 (\$0.81/Count) prime

BESARME 15 Pack Purse Hanger for Closet, Unique Twist Design Bag Hanger Hooks, Purses... \$9.99 (\$0.67/Count) prime

Fitnice 10 Pack Purse Hanger for Closet, S Hooks for Hanging Twisted Purse Hooks... \$9.99 (\$1.00/Count) prime

Products related to this item

Multiple product thumbnails showing various styles of bag hangers and hooks.

- 12 Pack Purse Hanger for Closet, Unique Twist Design, Large Size Closet Rod Hooks fo...
\$9.39 (\$0.78/Count)
[prime](#)
- 12 Pack Purse Hanger for Closet, Unique Twist Design Bag Hanger Purse Hooks, Large S...
\$9.69 (\$0.81/Count)
[prime](#)
- Purse Hangers 16 Pack Bag Hooks, Twist Shape Purse Hooks for Closet, Large Size Clo...
\$11.99 [prime](#)
- BESARME 15 Pack Purse Hanger for Closet, Unique Twist Design Bag Hanger Hooks, Purses...
\$9.99 (\$0.67/Count)
[prime](#)
- Purse Hanger for Closet, Unique Twist Design Bag Hanger Purse Hooks, Large Size Clo...
\$9.99 (\$0.83/Count)
[prime](#)
- CTOHN 20 Pack Purse Hanger for Closet, Unique Twist Design Bag Hanger Purse Hooks, ...
\$9.98 (\$0.50/Count)
[prime](#)
- BCISIWOS Purse Hanger for Closet, 10 Pack Handbag Hanger Organizer Unique...
\$6.99 [prime](#)

Videos

Videos for related products

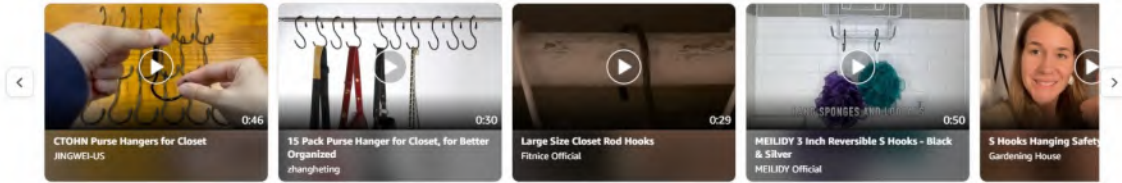

Upload your video

Looking for specific info?

Product Description

CertBuy 20 Pack 115 x 42 mm Purse Hanger for Closet, Purse Hooks, Purse Hangers, Hanging Hooks, Closet Hooks for Hanging Clothes

- Features:**
- Tough, durable construction and fine workmanship.
 - Widely used in kitchens, bathrooms, storage rooms, gardens, garages.
 - These 5-hooks can help you save a lot of space in wardrobes, cabinets, table.

Specifications:
 Color: black
 Material: iron
 Size: 4.5 x 1.6 inch / 115 x 42 mm

Package included:
 20 x 5 Hooks Heavy Duty

Product information

Product Dimensions	4.5 x 1.7 x 1 inches
Item Weight	12.6 ounces
Manufacturer	CertBuy
ASIN	B0C2VJ4DPS
Country of Origin	China
Item model number	20 Pack Purse Hanger for Closet
Customer Reviews	4.0 1 rating 4.0 out of 5 stars
Best Sellers Rank	#193,896 in Industrial & Scientific (See Top 100 in Industrial & Scientific) #2,350 in Utility Hooks #3,388 in Industrial Hooks #95,670 in Hardware
Maximum recommended load	100 Pounds
Number of pieces	20
Batteries required	No
Included Components	No

Warranty & Support

Product Warranty: For warranty information about this product, please [click here](#)

Feedback

Would you like to [tell us about a lower price?](#)

Important information

To report an issue with this product, [click here](#).

Compare with similar items

This Item CertBuy 20 Pack Purse Hanger for Closet, 4.5' Unique Twist Design Bag Hanger Purse Hooks, Closet Hooks for Hanging Handbags, Purses, Belts, Scarves, Hats, Clothes (Black)	12 Pack Purse Hanger for Closet, Unique Twist Design Bag Hanger Purse Hooks, Large Size Closet Rod Hooks for Hanging Necklace Bags, Purses, Handbags, Belts, Scarves, Hats, Clothes, Pans and Pots, Black	BESARME 15 Pack Purse Hanger for Closet, Unique Twist Design Bag Hanger Hooks, Purse Organizer Hooks for Closet Large Closet 5 Hooks for Hanging Handbags Purses Clothes (Black)	BCISIWOS Purse Hanger for Closet, 10 Pack Handbag Hanger Organizer Unique Twist Design Bag Hanger Purse Hooks, Large Size Closet Rod Hooks for Hanging Purses, Handbags, Clothes, Plant, Pots (Black)	Fitnice 10 Pack Purse Hanger for Closet, 5 Hooks for Hanging Twisted Purse Hooks Heavy Duty 5 Hooks Handbag Hanger Organizer Space Saving Closet Rod Hooks for Clothes, Bags, Plants, Pots (Black)
Add to Cart	Add to Cart	Add to Cart	Add to Cart	Add to Cart
Customer Rating ★★★★★ (1)	★★★★★ (1307)	★★★★★ (314)	★★★★★ (50)	★★★★★ (184)
Price \$15.99	\$9.99	\$9.99	\$6.99	\$9.99
Shipping FREE Shipping on orders over \$35.00 shipped by Amazon or get Fast, Free Shipping with Amazon Prime	FREE Shipping on orders over \$35.00 shipped by Amazon or get Fast, Free Shipping with Amazon Prime	FREE Shipping on orders over \$35.00 shipped by Amazon or get Fast, Free Shipping with Amazon Prime	FREE Shipping on orders over \$35.00 shipped by Amazon or get Fast, Free Shipping with Amazon Prime	FREE Shipping on orders over \$35.00 shipped by Amazon or get Fast, Free Shipping with Amazon Prime
Sold By CBtone	LiteViso	zhangheting	CJ Emerald	Fitnice Official
Color Black	Black	Black	Black	Black
Material Metal	Rubber, Alloy Steel	Vinyl	Stainless Steel	Stainless Steel, Plastic

Products related to this item

Sponsored

EZLAD 6-Inch Large S Hooks (Pack of 6), Non-Slip Vinyl Coated Black Hooks for Hangi...
★★★★★ 112
\$6.99 [prime](#)

Maltys 18 Pieces Purse Hanger Hook Acrylic Bag Hanger Handbag Tote Bag Rack Holder ...
★★★★★ 13
\$29.99 (\$1.67/Count)
[prime](#)

24 Pcs Metal Clothes Hanger Connector Hooks Stainless Steel Cascading Extender Conn...
★★★★★ 4
\$10.99 (\$0.46/Count)
[prime](#)

AMKJFO Hangers-Space-Saving-12 Pack - Closet-Organizers-and-Storage for Dorm...
★★★★★ 78
\$11.99 (\$1.00/Count)
[prime](#)

12 Pack Purse Hanger for Closet, Unique Twist Design, Large Size Closet Rod Hooks fo...
\$9.39 (\$0.78/Count)
[prime](#)

12 Pack Purse Hanger for Closet, Unique Twist Design Bag Purse Hooks, Large S...
★★★★★ 1,307
\$9.69 (\$0.81/Count)
[prime](#)

Purse Hangers 16 Pack Bag Hooks, Twist Shape Purse Hooks for Closet, Large Size Clo...
★★★★★ 42
\$11.99 [prime](#)

Heavy Duty S Hooks, 30 Pack, Black, by ESFUN...
★★★★★ 9,360
\$8.99 [prime](#)

Sponsored

Similar brands on Amazon

Sponsored

Wiosi
Shop the Store on Amazon

Purse Hanger Organizer for Closet 3 Pack - Durable Luxury Acrylic Holder for...
★★★★★ 449
\$29.99

HOME DEPUTY
Shop the Store on Amazon

HOME DEPUTY 6 Pack Purse Organizers for Closet - 6 Bag Hooks - Silver - Purse...
★★★★★ 511
\$12.50 Typical: \$13.60

FeeraHozor
Shop the Store on Amazon

Magic Pants Hangers Space Saving - 2 Pack for Closet Multiple Layers...
★★★★★ 11,525
\$21.99 List: \$29.99

Customer reviews

★★★★★ 4 out of 5

1 global rating

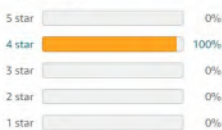

How customer reviews and ratings work

No customer reviews

There are 0 customer reviews and 1 customer rating.

Review this product

Share your thoughts with other customers

Write a customer review



Sponsored

Based on your recent shopping trends

Page 1 of 6

<p>60 Pack 5 Hooks for Hanging - 3 Size 5 Hooks Heavy Duty - Black 5 Hooks Silver Chrome Vinyl Coated - Steel... ★★★★★ 40 \$9.99 Get it as soon as Sunday, Nov 19 FREE Shipping on orders over \$35 shipped by Amazon</p>	<p>ZEDODIER 14 Pack Purse Hooks for Closet, Backpack Hanger Bag Holder, Closet Accessories Organizer... ★★★★★ 100 \$7.99 (\$0.57/Count) Get it as soon as Sunday, Nov 19 FREE Shipping on orders over \$35 shipped by Amazon</p>	<p>12 Pack 6 Inch 5 Hook, Large Vinyl Coated 5 Hooks with Rubber Stopper Non Slip Heavy... ★★★★★ 2,890 Amazon's Choice in Screw-In Hooks \$9.99 Get it as soon as Sunday, Nov 19 FREE Shipping on orders over \$35 shipped by Amazon</p>	<p>Evob 30 Pack Black 5 Hooks Steel 5 Hanging Hooks Heavy Duty 5 Hanger Hook Metal Kitchen Pot Rack Hook... ★★★★★ 11,881 \$17.47 (\$0.25/Count) Get it as soon as Sunday, Nov 19 FREE Shipping on orders over \$35 shipped by Amazon</p>	<p>Myfolreina Purse Hangers Bag Hooks Closet-12 Pack Handbag Hanger Organizer Metal S... ★★★★★ 329 Amazon's Choice in Utility Hooks \$9.99 Get it as soon as Sunday, Nov 19 FREE Shipping on orders over \$35 shipped by Amazon</p>	<p>Waltkey 8 Pack 5 Hooks for Hanging, 3.5 Inch Heavy Duty Metal S... ★★★★★ 2,261 Save 40% \$5.99 List: \$9.99 Lowest price in 30 days Get it as soon as Sunday, Nov 19 FREE Shipping on orders over \$35 shipped by Amazon</p>
---	--	--	--	---	--

Best Sellers in Industrial & Scientific

<p>MedPride Powder-Free Nitrile Exam Gloves, Medium, Box/100 ★★★★★ 86,073 Low returns #1 Best Seller in Industrial & Scientific \$9.99 (\$0.10/Count) Get it as soon as Sunday, Nov 19 FREE Shipping on orders over \$35 shipped by Amazon</p>	<p>iHealth COVID-19 Antigen Rapid Test, 1 Pack, 5 Tests Total, FDA EUA Authorized OTC a... ★★★★★ 19,056 #1 Best Seller in Clinical Diagnostic Test Kits \$44.95 (\$8.99/Count) Get it as soon as Sunday, Nov 19 FREE Shipping by Amazon</p>	<p>Cascade Platinum Plus ActionPacs Dishwasher Detergent Pods, Fresh, 62 Count ★★★★★ 87,486 #1 Best Seller in Commercial Dishwasher Detergents \$17.59 (\$0.28/Count) Get it as soon as Wednesday, Nov 22 FREE Shipping on orders over \$35 shipped by Amazon</p>	<p>Pampers Sensitive Baby Wipes - Baby Wipes Combo, 1008 Count, Water Based... ★★★★★ 198,946 #1 Best Seller in Electronic Component Sensors \$34.97 (\$3.47/100 Count) Get it as soon as Sunday, Nov 19 FREE Shipping on orders over \$35 shipped by Amazon</p>	<p>Med PRIDE NitrilPride Nitrile-Vinyl Blend Exam Gloves, Medium 100 - Powder Free, Latex Fre... ★★★★★ 40,932 Amazon's Choice in Medical Exam Gloves \$9.99 (\$0.10/Count) Get it as soon as Sunday, Nov 19 FREE Shipping on orders over \$35 shipped by Amazon</p>	<p>SYLVANIA ECO LED Light Bulb, A19 60W Equivalent, Efficient 9W, 7 Year, 750 Lumens... ★★★★★ 41,995 #1 Best Seller in LED Bulbs \$13.42 (\$1.68/Count) Get it as soon as Tuesday, Nov 21 FREE Shipping on orders over \$35 shipped by Amazon</p>
---	---	---	---	---	---

Customers who viewed items in your browsing history also viewed

Page 1 of 6

<p>12 Pack Purse Hanger for Closet, Unique Twist Design Bag Hanger Purse Hooks, Large Size Clos... ★★★★★ 1,507 Amazon's Choice in Tie Racks \$9.69 (\$0.81/Count) Get it as soon as Sunday, Nov 19 FREE Shipping on orders over \$35 shipped by Amazon</p>	<p>BESARME 15 Pack Purse Hanger for Closet, Unique Twist Design Bag Hanger Hooks, Purse... ★★★★★ 314 Amazon's Choice in Utility Hooks \$9.99 (\$0.67/Count) Get it as soon as Sunday, Nov 19 FREE Shipping on orders over \$35 shipped by Amazon</p>	<p>Purse Hanger Purse Organizer for Closet, 5 Hooks Twist Design Bag Hanger, Closet Rod Hooks for Hanging... ★★★★★ 459 \$8.98 (\$1.12/Count) Get it as soon as Sunday, Nov 19 FREE Shipping on orders over \$35 shipped by Amazon</p>	<p>ZEDODIER 14 Pack Purse Hooks for Closet, Backpack Hanger Bag Holder, Closet Accessories Organizer... ★★★★★ 100 \$7.99 (\$0.57/Count) Get it as soon as Sunday, Nov 19 FREE Shipping on orders over \$35 shipped by Amazon</p>	<p>BCISIWOS Purse Hanger for Closet, 10 Pack Handbag Hanger... ★★★★★ 30 Save 8% \$6.99 Typical: \$7.99 Lowest price in 30 days Get it as soon as Sunday, Nov 19 FREE Shipping on orders over \$35 shipped by Amazon</p>	<p>Fitnice 10 Pack Purse Hanger for Closet, 5 Hooks for Hanging Twisted Purse Hooks Heavy Duty 5 Hooks... ★★★★★ 184 \$9.99 (\$1.00/Count) Get it as soon as Monday, Nov 20 FREE Shipping on orders over \$35 shipped by Amazon</p>
--	--	---	--	--	--

See personalized recommendations

Sign in

Now customer? Start here.

Back to top

Get to Know Us

- Careers
- Amazon Newsletter
- About Amazon
- Accessibility
- Sustainability
- Press Center
- Investor Relations
- Amazon Devices
- Amazon Science

Make Money with Us

- Start Selling with Amazon
- Sell apps on Amazon
- Supply to Amazon
- Protect & Build Your Brand
- Become an Affiliate
- Become a Delivery Driver
- Start a Package Delivery Business
- Advertise Your Products
- Self-Publish with Us
- Host an Amazon Hub
- See More Ways to Make Money

Amazon Payment Products

- Amazon Visa
- Amazon Store Card
- Amazon Secured Card
- Amazon Business Card
- Shop with Points
- Credit Card Marketplace
- Reload Your Balance
- Gift Cards
- Amazon Currency Converter

Let Us Help You

- Your Account
- Your Orders
- Shipping Rates & Policies
- Amazon Prime
- Returns & Replacements
- Manage Your Content and Devices
- Your Recalls and Product Safety Alerts
- Help



English

United States

Amazon Music
Stream millions of songs

Amp
Have your own live radio show with music you love

Goodreads
Book reviews & recommendations

Amazon Warehouse
Great Deals on Quality Used Products

Amazon Ads
Reach customers wherever they spend their time

Amazon Fresh
Groceries & More Right To Your Door

IMDb
Movies, TV & Celebrities

Whole Foods Market
America's Healthiest Grocery Store

Neighbors App
Real-Time Crime & Safety Alerts

Epic
Score deals on fashion brands

AmazonGlobal
Ship Orders Internationally

IMDbPro
Get Info Entertainment Professionals Need

Woot!
Deals and Shenanigans

Amazon Subscription Boxes
Top subscription boxes -- right to your door

AbeBooks
Books, art & collectibles

Home Services
Experienced Pros. Happiness Guarantee

Kindle Direct Publishing
Indie Digital & Print Publishing Made Easy

Zappos
Shoes & Clothing

PillPack
Pharmacy Simplified

ACX
Audiobook Publishing Made Easy

Amazon Web Services
Scalable Cloud Computing Services

Amazon Photos
Unlimited Photo Storage Free With Prime

Ring
Smart Home Security Systems

Amazon Renewed
Like-new products you can trust

Sell on Amazon
Start a Selling Account

Audible
Listen to Books & Original Audio Performances

Prime Video Direct
Video Distribution Made Easy

eero WiFi
Stream 4K Video in Every Room

Blink
Smart Security for Every Home

Amazon Business
Everything For Your Business

Box Office Mojo
Find Movie Box Office Data

Shopbop
Designer Fashion Brands

Second Webpage Showing Sale of
Infringing Product Type 1

Home & Kitchen > Storage & Organization > Home Storage Hooks > Utility Hooks

12PCS 90° Hooks



- Features & Benefits:
- Holds Up to 60 Pounds
 - Strong & Stretch
 - Wide Application
 - Non rusting
 - Reusable



SHANDERBAR Purse Hanger for Closets, 12 PCS Large Hooks with 90 Degree Design and Unique Twisted Appearance, Ideal for Bags, Belts, Scarves, Hats, and Clothes, (Black)

Visit the SHANDERBAR Store 4.7 stars 26 ratings

Amazon's Choice in Utility Hooks by SHANDERBAR

\$8.99 (\$0.75 / Count)

Get Fast, Free Shipping with Amazon Prime

FREE Returns

Best price

Get a \$60 gift card instantly. Pay \$0.00 \$6.99 upon approval for the Amazon Store Card. Find out how

Color	Black
Brand	SHANDERBAR
Material	Alloy Steel
Finish Type	Steel
Mounting Type	Hanging, Pole

About this item

- Premium quality: Made of durable steel with a soft rubber coating to prevent scratches on your items and hands, these closet rod hooks are built to last.
- Space-saving design: With a unique S-hook twist design, these bag hanger closet hooks are perfect for vertical storage and organization, and can also be used for kitchen utensils and tools.
- Versatile size: Featuring a large opening of 1.7-1.8 inches, these hooks fit all regular closet poles up to 1.6 inches thick, making them easy to use in any space.
- Multi-functional: These heavy-duty S-shaped hooks are great for hanging a variety of items from clothing and handbags to utensils and birdhouses, making them a practical gift for anyone.
- Value pack: Each pack comes with 12 black hooks, giving you enough for all your daily needs. Our top priority is customer satisfaction, so please don't hesitate to contact us with any questions or concerns you may have.

See more product details



Sponsored

prime Enjoy fast, FREE delivery, exclusive deals and award-winning movies & TV shows with Prime Try Prime and start saving today with Fast, FREE Delivery

\$8.99 (\$0.75 / Count) Get Fast, Free Shipping with Amazon Prime FREE Returns FREE delivery Monday, November 20 on orders shipped by Amazon over \$35

Or fastest delivery Thursday, November 16. Order within 11 hrs 31 mins

Delivering to Albany 12201 - Update location

In Stock

Qty: 1

Add to Cart

Buy Now

Ships from Amazon Sold by JRUJIA Returns Returnable until Jan 31, 2024 Payment Secure transaction

Add a gift receipt for easy returns

Add to List



iBetterLife Clothes Pins Heavy... 4.7 stars 1,676 \$8.99 prime Save 5% with coupon

Sponsored

Buy it with



Total price: \$27.78

Add all 3 to Cart

Some of these items ship sooner than the others. Show details

This item: SHANDERBAR Purse Hanger for Closets, 12 PCS Large Hooks with 90 Degree Design a... \$8.99 (\$0.75/Count)

NearMoon Self Adhesive Hand Towel Holder/Towel Ring, Stainless Steel Hand Towel Bar... \$12.99

Scotch Duct Tape, Pink, 1.88-Inch by 20-Yard \$5.99

Products related to this item

Page 1 of 35



4 stars and above

Page 1 of 58



Infringing Product Type 1

Hanging Safety Buckle - 3.5 inch Heavy Duty 5 Hooks, Hanging Pl...
 ★★★★★ 309
 \$11.99 (\$0.60/Fl Oz)
 ✓prime

Organizer for Closet - 6 Bag Hooks - Black - Purse Hangers for Cl...
 ★★★★★ 511
 \$12.50 (\$2.08/Count)
 ✓prime

Hanger for Closet, 5 Hooks for Hanging Twisted Purse Hooks...
 ★★★★★ 184
 \$9.99 (\$1.00/Count)
 ✓prime

Organizer for Closet, 5 Hooks Twist Design Bag Hanger, Closet Rod ...
 ★★★★★ 439
 \$8.98 (\$1.12/Count)
 ✓prime

for Closet, Unique Twist Design Bag Hanger Purse Hooks, Large S...
 ★★★★★ 1,307
 \$9.69 (\$0.81/Count)
 ✓prime

Hanger for Closet, Unique Twist Design Bag Hanger Hooks, Purses...
 ★★★★★ 314
 \$9.99 (\$0.67/Count)
 ✓prime

Hanger for Closet, Unique Twist Design Bags Hanger Hooks...
 ★★★★★ 457
 \$7.99 ✓prime

From the brand

SHANDERBAR
 —Make your life more colorful

SHANDERBAR has always been committed to providing customers with high-quality products. Although the company is a small one, it has always helped customers achieve a simple and comfortable high-quality life, making things simpler, easier, and more thoughtful, and making customers' lives more colorful!

Product Visit the store

Product Description

Perfect heavy-duty 5-shaped hooks



Say goodbye to your messy wardrobe and make your life more enjoyable



Use our unique twist design bag hook to save more space and store more bags in the closet.

Multi functional and multi scenario use



Kitchen
You can use these unique twist design bag hooks in your kitchen to prevent kitchen utensils from being everywhere and make your kitchen less messy



Bathroom
Our Purse Hanger Purse Organizer for Closet can not only be used in your wardrobe, but also hang your towels, clothes, and other items in the bathroom, providing a better experience



Outdoor
Used for hanging cups, bird houses, bird feeders, displaying plants, pots and pans. It is your perfect helper for saving space.

Videos

Videos for related products

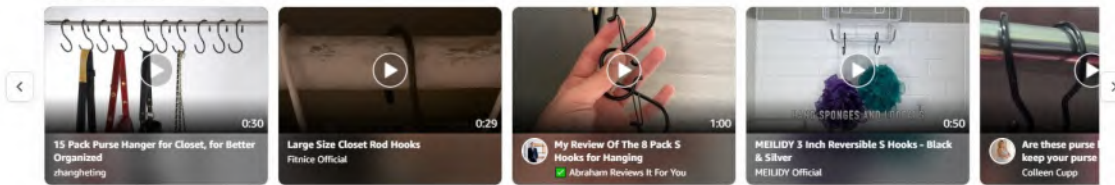

Upload your video

Looking for specific info?

Product information

Technical Details

Color	Black
Brand	SHANDERBAR
Material	Alloy Steel
Finish Type	Steel
Mounting Type	Hanging Pole
Style	Twisted
Shape	Hands
Included Components	no
Item Dimensions LxWxH	7 x 5.12 x 2.76 inches
Number of Hooks	12
Maximum Weight Recommendation	3.5 Kilograms
Manufacturer	SHANDERBAR
Part Number	A123
Item Weight	7.4 ounces
Product Dimensions	7 x 5.12 x 2.76 inches
Country of Origin	China
Item model number	A123
Finish	Steel
Batteries Required?	No

Additional Information

ASIN	B0C1SMCC6W
Customer Reviews	4.7 26 ratings 4.7 out of 5 stars
Best Sellers Rank	#339,634 in Home & Kitchen (See Top 100 in Home & Kitchen) #808 in Utility Hooks
Date First Available	April 7, 2023

Warranty & Support

Amazon.com Return Policy: **Amazon.com Voluntary 30-Day Return Guarantee:** You can return many items you have purchased within 30 days following delivery of the item to you. Our Voluntary 30-Day Return Guarantee does not affect your legal right of withdrawal in any way. You can find out more about the exceptions and conditions here.

Product Warranty: For warranty information about this product, please click here

Feedback

Would you like to [tell us about a lower price?](#)

WARNING:

CHOKING HAZARD -- Toy contains a small ball. Not for children under 3 yrs. To be used under the direct supervision of an adult

Compare with similar items

This item SHANDERBAR Purse Hanger for Closets, 12 PCS Large Hooks with 90 Degree Design and Unique Twisted Appearance. Ideal for Bags, Belts, Scarves, Hats, and Clothes, (Black)	12 Pack Purse Hanger for Closet, Unique Twist Design Bag Hanger Purse Hooks, Large Size Closet Rod Hooks for Hanging Necklace Bags, Purses, Handbags, Belts, Scarves, Hats, Clothes, Pans and Pots, Black	Purse Hanger Purse Organizer for Closet, 5 Hooks Twist Design Bag Hanger, Closet Rod Hooks for Hanging Handbags, Purses, Belts, Scarves, Hats, Clothes, Pots and Pans. (8 Pack Black)	Fitnice 10 Pack Purse Hanger for Closet, 5 Hooks for Hanging Twisted Purse Hooks Heavy Duty 5 Hooks Handbag Hanger Organizer Space Saving Closet Rod Hooks for Clothes, Bags, Plants, Pots (Black)	BESARME 15 Pack Purse Hanger for Closet, Unique Twist Design Bag Hanger Hooks, Purse Organizer Hooks for Closet Large Closet 5 Hooks for Hanging Handbags Purses Clothes (Black)
Add to Cart	Add to Cart	Add to Cart	Add to Cart	Add to Cart
Customer Rating ★★★★★ (26)	★★★★★ (1307)	★★★★★ (439)	★★★★★ (184)	★★★★★ (314)
Price \$8.99	\$9.99	\$8.98	\$9.99	\$9.99
Shipping FREE Shipping on orders over \$35.00 shipped by Amazon or get Fast, Free Shipping with Amazon Prime	FREE Shipping on orders over \$35.00 shipped by Amazon or get Fast, Free Shipping with Amazon Prime	FREE Shipping on orders over \$35.00 shipped by Amazon or get Fast, Free Shipping with Amazon Prime	FREE Shipping on orders over \$35.00 shipped by Amazon or get Fast, Free Shipping with Amazon Prime	FREE Shipping on orders over \$35.00 shipped by Amazon or get Fast, Free Shipping with Amazon Prime
Sold By JRUIA	LiteViso	NEZA-US	Fitnice Official	zhangheting
Color Black	Black	Black	Black	Black
Material Alloy Steel	Rubber, Alloy Steel	Metal, Vinyl	Stainless Steel, Plastic	Vinyl

Videos for this product

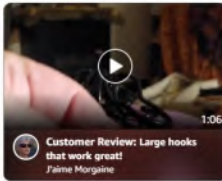

Important information

To report an issue with this product, click here.

Products related to this item

Page 1 of 20

Sponsored

★★★★★ 45 \$22.95 (\$4.59/Count) prime	★★★★★ 31 \$18.58 (\$4.65/Count) prime Save 20% with coupon	★★★★★ 511 \$12.50 (\$2.08/Count) prime	★★★★★ 1,307 \$16.89 (\$1.06/Count) prime Save 10% with coupon	★★★★★ 1,307 \$9.69 (\$0.81/Count) prime	★★★★★ 314 \$9.99 (\$0.67/Count) prime	★★★★★ 314 \$9.39 (\$0.78/Count) prime

Sponsored

	S Hooks, 30 Pack, Heavy Duty, Black... ★★★★★ 3,360 \$8.99 prime
--	---

Similar brands on Amazon

Page 1 of 2



Customer reviews

★★★★☆ 4.7 out of 5

26 global ratings

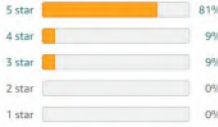

How customer reviews and ratings work

Review this product

Share your thoughts with other customers

Write a customer review

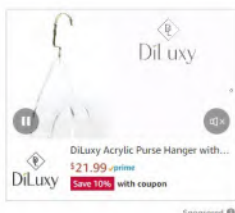

Reviews with images

See all photos >



Read reviews that mention

- large enough, hang bags, closet, hook, purses, items, space, belts, handy, metal, coated, hanger, hanging, rod, rubber, shape, degree, purpose, scarves, twisted

Top reviews

Top reviews from the United States

Texas-ness Problem Solver for us. Reviewed in the United States on May 17, 2023. Vine Customer Review of Free Product... For the closet, the tool shed, the doors, windows, the rear gate, for seasonal hangings that don't need a sticky strip, and I can hang a pound or two safely. My wife's purse collecting fetish clogging up her closet is why I bought these. She hangs them from hangers...multiple purses, bags, bras, handcuffs, latigo, bridle...everything in her closet, and these hooks became a great solution. They're coated in rubber or latex and tipped. Each hook has 2 hooks, and one is larger than the other...for more bags to hang on. 4 stars because I feel like more than 2 pounds and they will begin bending. They are metal. I will be ordering more.



Helpful Report

Marcie Dallas VINE VOICE Works good for light items. Reviewed in the United States on August 1, 2023. Vine Customer Review of Free Product... These work great for what they are marketed for like belts and scarves. They are easy to hang pretty much anywhere so you don't need a lot of space for them. They are nice to have for all the odd things that you don't have a place to hang.

Helpful Report

ring0 VINE VOICE Well coated. Bendable if you really try. Reviewed in the United States on May 20, 2023. Vine Customer Review of Free Product... These hooks are very well coated (though I wish I knew with what - it doesn't smell like PVC). If you pull/push hard you can in fact bend them, so I would want to use them for tools in the garage. For clothing they should be fine.

Helpful Report

Coco Leche VINE VOICE Don't pass on these fantastic, versatile multi-purpose hooks! Reviewed in the United States on June 3, 2023. Vine Customer Review of Free Product... I love these hooks and are a great buy for just \$1 apiece! These are large and better than regular S hooks. These twisted hooks are space savers that look and feel well-made and very sturdy. They're described as being able to hold up to 50 pounds, and I believe it. These unique hooks are a great way to help you stay organized. I imagine you can use them in every area of your home. I use one to hang my small ladder up in the basement so I can stop kicking it as I walk by the place I had it propped up in the kitchen. They make the best purse hangers, can be used to hang plants outside or belts in your bedroom closet, and are a stylish and durable way to hang your pots and pans in the kitchen. They are sleek and black, fitting any décor, and have rubber tips to protect your items and possibly keep the hooks from slipping off. They are also large enough to fit nearly any rod.

I wish I had gotten some of these a long time ago. You should grab some so you can see how great they are as well.



Helpful Report

Rick Dean

★★★★★ **Serve their intended purpose very well and are stronger than I assumed.**

Reviewed in the United States on May 30, 2023

Vine Customer Review of Free Product (What's this?)

First off, these are marketed as closet hangers for bags, belts clothes etc. So, I only tested them in that capacity and only use them for that and they come in very handy as such. I was looking for something to help organize my belts better in my closet and one of these holds quite a few of them in a fashion that I can clearly see which ones I have hung.

These hooks have a rubber coating and are quite sturdy. I pulled on them and it takes a bit of force to get them to bend, much more force than any of the above listed items would place on them. The heaviest thing I have in my closet is a tactical vest with front and back ballistic plates in it. I hung that hanger from these hooks and there was no give at all. I have used quite a few to hang my wife's bags in the back of the closet as well. Due to the shape of these hooks the bags hang with the smaller sides facing out, conserving space in the closet. I am very happy I stumbled across these and am very happy with them. I will be getting more to hang more bags of my wife's.



Helpful Report

SC

★★★★★ **Convenient, fit on a variety of closet hanging solutions**

Reviewed in the United States on June 21, 2023

Vine Customer Review of Free Product (What's this?)

These are big, they fit on every hanging rack on every closet in my house. Others only fit on the thinnest metal rods, but these fit larger rods as well. They are completely coated, not just the tips. Not sure what they're coated in, but it's kind of cushioned and grippy. Working nicely to hang bags in my closet. They seem very sturdy when used to hang bags. I have one or two bags on each hook. Would order them again.

Helpful Report

Zoe Bloom VINE VOICE

★★★★★ **Exactly what I have been searching for!**

Reviewed in the United States on May 26, 2023

Vine Customer Review of Free Product (What's this?)

You know how sometimes you know what you want but don't know the right thing to call it so it's very hard to search for it? That was exactly my situation with these hangers. I had found variations of them that sort of solved the problem, but they involved threading the top part of the hanger on a rod, which made it impossible to remove without taking the whole rod down. These hangers are perfect! You can move them around so easily. They're so nice because things with handles, like purses, can neatly hang perpendicular to the wall. These hangers are really well-made. They are not at all flimsy and could hold a fair amount of weight if you needed them to. Don't hesitate. They are really great!

Helpful Report

Whitney Sims VINE VOICE

★★★★★ **LIFE Saving**

Reviewed in the United States on May 30, 2023

Vine Customer Review of Free Product (What's this?)

So glad I found this the. hangers that came with the closet we use now easily, break upon placing a purse on it. Even though it was meant for purses. These are so thick and durable. Can hang two purses if not more on one of these opposed to what I was able to do before. I'm so happy. I found this because it has been a major struggle with my closet being so jam packed with bags. It's nice to have a simple. item that gives me the room that I need. And I don't have to worry about my son or bags being ruined by a cheap. hanger. I highly recommend these to anyone who is a bag enthusiast.

Helpful Report

See more reviews >

Customers frequently viewed

Sponsored | Popular products in the last 7 days

Page 1 of 19

★★★★★ 100 \$7.99 (\$0.57/Count) prime	★★★★★ 42 \$6.99 (\$0.70/Count) prime	★★★★★ 11 \$5.99 (\$0.60/Count) prime	★★★★★ 519 \$6.99 (\$0.41/Count) prime	★★★★★ 314 \$9.99 (\$0.67/Count) prime	★★★★★ 227 \$9.99 prime	★★★★★ 30 \$9.99 (\$0.83/Count) prime

iBetterLife Clothes Pins Heavy Duty Outdoor - 4 P...
 \$8.99 prime
 Save 5% with coupon

Sponsored



#1 Best Seller in Home & Kitchen

\$35.00

Get it as soon as **Wednesday, Nov 22**

FREE Shipping by Amazon

#1 Best Seller in Bed Pillow Pillowcases

\$16.98 (\$3.49/Count)

Get it as soon as **Sunday, Nov 19**

FREE Shipping on orders over \$35 shipped by Amazon

Climate Pledge Friendly

#1 Best Seller in Sheet & Pillowcase Sets

\$29.99

Get it as soon as **Sunday, Nov 19**

FREE Shipping on orders over \$35 shipped by Amazon

Climate Pledge Friendly

#1 Best Seller in Throw Pillow Inserts

\$16.99 (\$8.50/Count)

Get it as soon as **Sunday, Nov 19**

FREE Shipping on orders over \$35 shipped by Amazon

Climate Pledge Friendly

Upholstery Cleaning Machines

28% off Deal

\$89.00

List: \$122.99

Get it as soon as **Sunday, Nov 19**

FREE Shipping by Amazon

Blankets

48% off Deal

\$20.89

List: \$39.99

Get it as soon as **Monday, Nov 20**

FREE Shipping on orders over \$35 shipped by Amazon

Customers who viewed items in your browsing history also viewed

12 Pack Purse Hanger for Closet, Unique Twist Design Bag Hanger Purse Hooks, Large Size Clos...

★★★★☆ 1,307

Amazon's Choice in Tie Racks

\$9.69 (\$0.81/Count)

Get it as soon as **Sunday, Nov 19**

FREE Shipping on orders over \$35 shipped by Amazon

Purse Hanger Purse Organizer for Closet, 5 Hooks Twist Design Bag Hanger, Closet Rod Hooks for Hanging...

★★★★☆ 439

\$18.98 (\$1.12/Count)

Get it as soon as **Sunday, Nov 19**

FREE Shipping on orders over \$35 shipped by Amazon

BESARME 15 Pack Purse Hanger for Closet, Unique Twist Design Bag Hanger Hooks, Purse...

★★★★☆ 314

Amazon's Choice in Utility Hooks

\$19.99 (\$0.67/Count)

Get it as soon as **Sunday, Nov 19**

FREE Shipping on orders over \$35 shipped by Amazon

Fitrice 10 Pack Purse Hanger for Closet, 5 Hooks for Hanging Twisted Purse Hooks Heavy Duty 5 Hooks...

★★★★☆ 184

\$9.99 (\$1.00/Count)

Get it as soon as **Monday, Nov 20**

FREE Shipping on orders over \$35 shipped by Amazon

ZEDODIER 14 Pack Purse Hooks for Closet, Backpack Hanger Bag Holder, Closet Accessories Organizer ...

★★★★☆ 100

\$17.99 (\$0.57/Count)

Get it as soon as **Sunday, Nov 19**

FREE Shipping on orders over \$35 shipped by Amazon

Myfolrenea Purse Hangers Bag Hooks Closet-12 Pack Handbag Hanger Organizer Metal 5 Hooks, Large Size Clos...

★★★★☆ 229

\$9.99

Get it as soon as **Sunday, Nov 19**

FREE Shipping on orders over \$35 shipped by Amazon

See personalized recommendations

[Sign in](#)

New customer? Start here.

Back to top

Get to Know Us

- Careers
- Amazon Newsletter
- About Amazon
- Accessibility
- Sustainability
- Press Center
- Investor Relations
- Amazon Devices
- Amazon Science

Make Money with Us

- Start Selling with Amazon
- Sell apps on Amazon
- Supply to Amazon
- Protect & Build Your Brand
- Become an Affiliate
- Become a Delivery Driver
- Start a Package Delivery Business
- Advertise Your Products
- Self-Publish with Us
- Host an Amazon Hub
- See More Ways to Make Money

Amazon Payment Products

- Amazon Visa
- Amazon Store Card
- Amazon Secured Card
- Amazon Business Card
- Shop with Points
- Credit Card Marketplace
- Reload Your Balance
- Gift Cards
- Amazon Currency Converter

Let Us Help You

- Your Account
- Your Orders
- Shipping Rates & Policies
- Amazon Prime
- Returns & Replacements
- Manage Your Content and Devices
- Your Recalls and Product Safety Alerts
- Help

amazon English United States

Amazon Music

Stream millions of songs

Amazon Ads

Reach customers whenever they spend their time

Spn

Score deals on fashion brands

AbeBooks

Books, art, & collectibles

ACX

Audiobook Publishing Made Easy

Sell on Amazon

Start a Selling Account

Amazon Business

Everything For Your Business

Amp

Host your own live radio show with music you love

Amazon Fresh

Groceries & More Right To Your Door

Amazon Global Ship Orders Internationally

Home Services

Experienced Pros. Happiness Guarantee.

Amazon Web Services

Scalable Cloud Computing Services

Audible

Listen to Books & Original Audio Performances

Box Office Mojo

Find Movie Box Office Data

Goodreads

Book reviews & recommendations

IMDb

Movies, TV & Celebrities

IMDbPro

Get Info Entertainment Professionals Need

Kindle Direct Publishing

Indie Digital & Print Publishing Made Easy

Amazon Photos

Unlimited Photo Storage. Free With Prime

Prime Video Direct

Video Distribution Made Easy

Shopbop

Designer Fashion Brands

Amazon Warehouse

Great Deals on Quality Used Products

Whole Foods Market

America's Healthiest Grocery Store

Woot!

Deals and Shenigans

Zappos

Shoes & Clothing

Ring

Smart Home Security Systems

eero WiFi

Stream 4K Video in Every Room

Blink

Smart Security for Every Home

Neighbors App

Real-Time Crime & Safety Alerts

Amazon Subscription Boxes

Top subscription boxes — right to your door

PillPack

Pharmacy Simplified

Amazon Renewed

Like-new products you can trust

Third Webpage Showing Sale of
Infringing Product Type 1

Home & Kitchen > Storage & Organization > Home Storage Hooks > Utility Hooks

PRODUCT SIZE



BCISIWOS Purse Hanger for Closet, 10 Pack Handbag Hanger Organizer Unique Twist Design Bag Hanger Purse Hooks, Large Size Closet Rod Hooks for Hanging Purses, Handbags, Clothes, Plant, Pots(Black)

Brand: BCISIWOS 4.7 stars 30 ratings Amazon's Choice in Utility Hooks by BCISIWOS 100+ bought in past month

Lowest price in 30 days -8% \$6.99 Typical price: \$7.49

Get Fast, Free Shipping with Amazon Prime FREE Returns Best price

Get a \$60 gift card instantly Pay \$0.00 \$6.99 upon approval for the Amazon Store Card Find out how

Color: Black \$6.99 \$7.99

Table with 2 columns: Property (Color, Brand, Material, Finish Type, Mounting Type) and Value (Black, BCISIWOS, Stainless Steel, Metal, Ceiling Mount, Door Mount, Wall Mount)

About this item

- Unique Twist Design Gives You More Space in Your Closet. We've improved the regular S-hooks by rotating them 90 degrees so you can use these purse hooks to neatly hang purses, jeans, belts, hats, necklaces and more in your closet.
Rubber Coated Surface & Rubber Caps Design: The purse closet organizer is coated with a vinyl rubber coating. The rubberized coating not only prevents sliding and keeps all your items spaced out, it also prevents rust and scratches.
4.5 Inch Closet Rod Hooks: The handbag organizer measures 1.7 inches in one opening and 1.8 inches in the other and fits all regular closet rods less than 1.6 inches thick.
Handy and Sturdy: Package comes with 10 pack black hanger hooks. Not require to use tools, nails, screws, or adhesives, these handbag organizers are easy to hang on existing objects.
Various Application: These closet purse hooks are great for hanging purses, book bags, backpacks, duffle bags, tote bags, porting bags, laptop totes, travel belts, scarves, hats, towels, gym shorts, coffee mugs, robes, bras, bathing suits, bikinis, plant, wind chimes, wreaths, Christmas stockings, brooms, dusters, and mops cleaning tools etc.

Customer ratings by feature

Table with 2 columns: Feature (Easy to use, Sturdiness, Versatility) and Rating (5.0, 5.0, 4.8 stars)

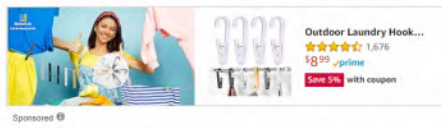

prime Enjoy fast, FREE delivery, exclusive deals and award-winning movies & TV shows with Prime Try Prime and start saving today with Fast, FREE Delivery

\$6.99 Get Fast, Free Shipping with Amazon Prime FREE Returns FREE delivery Sunday, November 19 on orders shipped by Amazon over \$35

Or fastest delivery Thursday, November 16. Order within 10 hrs 59 mins

Delivering to Albany 12201 - Update location

In Stock Qty: 1 Add to Cart Buy Now

Ships from Amazon Sold by CJ Emerald Returns Returnable until Jan 31, 2024 Payment Secure transaction Add a gift receipt for easy returns Add to List

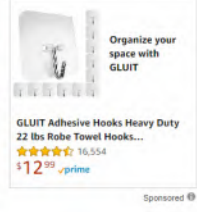

Infringing Product Type 1

Frequently bought together



This item: BCISIWOS Purse Hanger for Closet, 10 Pack Handbag Hanger Organizer... \$6.99 Waitkey 8 Pack S Hooks for Hanging, 3.5 inch Heavy Duty Metal S Shaped Hooks with Safe... \$5.99

Total price: \$12.98 Add both to Cart

These items are shipped from and sold by different sellers. Show details

4 stars and above

Page 1 of 58

Sponsored

★★★★★ 100 \$7.99 ✓prime	★★★★★ 227 \$9.99 ✓prime	★★★★★ 213 \$12.99 (\$6.50/Count) ✓prime	★★★★★ 457 \$7.99 ✓prime	★★★★★ 314 \$9.99 (\$0.67/Count) ✓prime	★★★★★ 1,307 \$9.69 (\$0.81/Count) ✓prime	★★★★★ 439 \$6.98 (\$1.12/Count) ✓prime

Products related to this item

Page 1 of 58

Sponsored

★★★★★ 314 \$9.99 (\$0.67/Count) ✓prime	★★★★★ 1,307 \$9.69 (\$0.81/Count) ✓prime	★★★★★ 100 \$7.99 (\$0.57/Count) ✓prime	★★★★★ 439 \$8.98 (\$1.12/Count) ✓prime	★★★★★ 37 \$9.99 (\$0.83/Count) ✓prime	★★★★★ 17 \$9.98 (\$0.59/Count) ✓prime	★★★★★ 1 \$15.99 ✓prime

Product Description



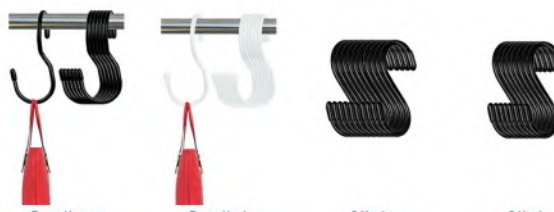

	Purse Hanger	Purse Hook	S Hooks	S Hook
Size	4.5 Inch	4.5 Inch	3.5 Inch	3.5 Inch
Color	Black	White	Black	Black
Material	Vinyl Coated	Vinyl Coated	Metal	Metal
Quantity	10	12	10	8
Rubber Coated	✓	✓	✓	✓
Anti Rust	✓	✓	✓	✓

Looking for specific info?

🔍 Search in reviews, Q&A...

Product information

Color	Black
Brand	BCISIWOS
Material	Stainless Steel
Finish Type	Metal
Mounting Type	Ceiling Mount, Door Mount, Wall Mount
Style	Contemporary
Weight Limit	22 Pounds
Special Feature	Heavy Duty, Non Slip, Rust Resistant
Recommended Uses For Product	Hangers, Purse, Utility, Kitchen, Closet, Cup And Mug, Bag, Handbag, Hat, Hall Trees, Offices
Shape	S Shape
Theme	Purse Hanger
Item Weight	3.84 Ounces
Item Dimensions LxWxH	3.5 x 1.5 x 0.65 inches
Number of Hooks	10
Minimum Weight Capacity	22 Pounds
Surface Recommendation	Metal
Maximum Weight Recommendation	22 Pounds
Product Dimensions	3.5 x 1.5 x 0.65 inches
Item Weight	3.84 ounces
Manufacturer	BCISIWOS
ASIN	B0BY6MRN1H
Country of Origin	China
Item model number	S Hooks CJ 20230312
Customer Reviews	4.7  - 30 ratings 4.7 out of 5 stars
Best Sellers Rank	#109,088 in Home & Kitchen (See Top 100 in Home & Kitchen) #332 in Utility Hooks
Specific instructions for use	Professional
Finish types	Metal
Batteries required	No

Warranty & Support

Product Warranty: For warranty information about this product, please [click here](#)

Feedback

Would you like to [tell us about a lower price?](#)

Videos

Page 1 of 2

Videos for related products

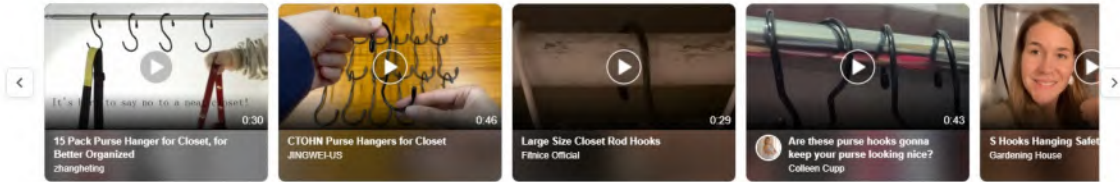

[Upload your video](#)

Important information

To report an issue with this product, [click here](#).

Compare with similar items

This item BCISIWOS Purse Hanger for Closet, 10 Pack Handbag Hanger Organizer Unique Twist Design Bag Hanger Purse Hooks, Large Size Closet Rod Hooks for Hanging Purses, Handbags, Clothes, Plant, Pots(Black)	Purse Hanger Purse Organizer for Closet, S Hooks Twist Design Bag Hanger, Closet Rod Hooks for Hanging Handbags, Purses, Belts, Scarves, Hats, Clothes, Pots and Pans. (8 Pack Black)	12 Pack Purse Hanger for Closet, Unique Twist Design Bag Hanger Purse Hooks, Large Size Closet Rod Hooks for Hanging Necklace Bags, Purses, Handbags, Belts, Scarves, Hats, Clothes, Pans and Pots, Black	BESARME 15 Pack Purse Hanger for Closet, Unique Twist Design Bag Hanger Hooks, Purse Organizer Hooks for Closet Large Closet S Hooks for Hanging Handbags Purses Clothes(Black)	ZEDODIER 14 Pack Purse Hooks for Closet, Backpack Hanger Bag Holder, Closet Accessories Organizer S Hook for Hanging Purses, Handbags, Bags, Belts, Scarves, Hats, Clothes, and Plant, Silver
Add to Cart	Add to Cart	Add to Cart	Add to Cart	Add to Cart
Customer Rating ★★★★★ (30)	★★★★★ (439)	★★★★★ (1307)	★★★★★ (314)	★★★★★ (100)
Price \$6.99	\$8.98	\$9.99	\$9.99	\$7.99
Shipping FREE Shipping on orders over \$35.00 shipped by Amazon or get Fast, Free Shipping with Amazon Prime	FREE Shipping on orders over \$35.00 shipped by Amazon or get Fast, Free Shipping with Amazon Prime	FREE Shipping on orders over \$35.00 shipped by Amazon or get Fast, Free Shipping with Amazon Prime	FREE Shipping on orders over \$35.00 shipped by Amazon or get Fast, Free Shipping with Amazon Prime	FREE Shipping on orders over \$35.00 shipped by Amazon or get Fast, Free Shipping with Amazon Prime
Sold By CJ Emerald	NEZA-US	LiteViso	zhangheting	ZEDODIER
Color Black	Black	Black	Black	Silver
Material Stainless Steel	Metal, Vinyl	Rubber, Alloy Steel	Vinyl	Metal

Products related to this item

Page 1 of 2

Sponsored

- Purse Hangers 16 Pack Bag Hooks, Twist Shape Purse Hooks for Closet, Large Size Clo...**
★★★★★ 42
\$11.99 ✓prime
- CoHoXXYY Acrylic Purse Hanger Closet Keep Your Toes and Backpacks Organized and in...**
★★★★★ 31
\$18.58 (\$4.65/Count) ✓prime
- HOME DEPUTY Purse Organizer for Closet - 6 Bag Hooks - Gold - Purse Hangers for Clo...**
★★★★★ 511
\$12.50 (\$2.08/Count) ✓prime
- Simple Houseware Standing Coat and Hat Hanger Organizer Rack, 12 Hooks Turquoise**
★★★★★ 15,368
\$22.97 ✓prime
- BESARME 15 Pack Purse Hanger for Closet, Unique Twist Design Bag Hanger Hooks, Purses...**
★★★★★ 314
\$9.99 (\$0.67/Count) ✓prime
- 12 Pack Purse Hanger for Closet, Unique Twist Design Bag Hanger Purse Hooks, Large S...**
★★★★★ 1,307
\$9.69 (\$0.81/Count) ✓prime
- ZEDODIER 14 Pack Purse Hooks for Closet, Backpack Hanger Bag Holder, Closet Accesso...**
★★★★★ 100
\$7.99 (\$0.57/Count) ✓prime

Sponsored

Amazon Brand - Wag Dry Dog Food Salmon & Sweet Potato
★★★★★ 19,672
22% off Deal
\$44.99 ~~\$57.99~~ ✓prime
[Shop now](#)

Similar brands on Amazon

Page 1 of 2

Sponsored

- GLUIT**
Shop the Store on Amazon
GLUIT Adhesive Hooks Heavy Duty 22 lbs Robe Towel Hooks Waterproof Adhesive...
★★★★★ 16,554
\$12.99 List: \$14.99
- SEEBRIDER**
Shop the Store on Amazon
SEEBRIDER Purse Hanger Closet, Purse Holder for Closet Grey Backpack Hanger...
\$16.99
- Rolly Hanger**
Shop the Store on Amazon
Multipurpose Closet Hanger Organizer ROLLY HANGER Great Space Saver Cu...
★★★★★ 760
\$17.95 List: \$20.99

Customer reviews

★★★★★ 4.7 out of 5

30 global ratings

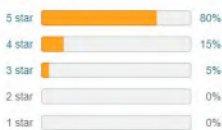

How customer reviews and ratings work

Reviews with images



Top reviews

Top reviews from the United States

See all photos

By feature

- Easy to use ★★★★★ 5.0
- Sturdiness ★★★★★ 5.0
- Versatility ★★★★★ 4.8

Review this product

Share your thoughts with other customers

Write a customer review

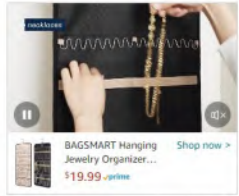

Speech Lady

★★★★★ Great "twist" to the standard hook

Reviewed in the United States on November 11, 2023

Color: Black **Verified Purchase**

This twisted hook solved my problem in my camper closet. I needed to hang a basket but couldn't do it without the twist in the hook. These are excellent and solved my problem perfectly.

Helpful Report

Quincy

★★★★☆ Hooks are a lot bigger than pictured

Reviewed in the United States on October 22, 2023

Color: Black **Verified Purchase**

I like the shape and durability but way bigger than expected!!! I could use some that are thinner and smaller!

Helpful Report

SP

★★★★★ Great buy

Reviewed in the United States on September 29, 2023

Color: Black **Verified Purchase**

Perfect for hanging my braid extensions

Helpful Report

J Rich

★★★★★ Great! Just what needed!

Reviewed in the United States on September 20, 2023

Color: Black **Verified Purchase**

Perfect hooks. Great quality! Great if you need things facing forward. Used them for hanging wind chimes!



Helpful Report

J

★★★★★ Great for hanging bags!

Reviewed in the United States on August 14, 2023

Color: Black **Verified Purchase**

Great for getting bags of the floor and making space! These work really well. Work well for cruises too.

One person found this helpful

Helpful Report

ali

★★★★★ They work!!

Reviewed in the United States on August 11, 2023

Color: Black **Verified Purchase**

These little hangers work great! They are durable and do exactly what I wanted. I hang my purses, bags and towels on them.

One person found this helpful

Helpful Report

anita

★★★★★ Great for organizing the camper!

Reviewed in the United States on August 25, 2023

Color: Black **Verified Purchase**

So many options

One person found this helpful

Helpful Report

See more reviews >

More from frequently bought brands

Page 1 of 22

Sponsored

Maltys 18 Pieces Purse Hanger Hook Acrylic Bag Hanger Handbag Tote Bag Rack Holder ...
★★★★☆ 13
\$29.99 (\$1.67/Count)
-prime

HIGIT 12 Pack Large S Hooks for Closet, 5 Inch Rubber Coated S Hooks for Hanging H...
★★★★☆ 30
\$9.99 (\$0.83/Count)
-prime

Purse Organizer for Closet, 360 Degree Swivel Purse Hanger Bag Hook Organizer- Vet...
★★★★☆ 42
\$7.99 -prime
Save 10% with coupon

Purses Hanger Organizer for Closet, Mylorena Metal Purse Holder for Closet Space S...
★★★★☆ 313
\$6.99 (\$0.58/Pt Oz)
-prime

Mylorena Purse Hangers Bag Hooks Closet- 12 Pack Handbag Hanger Organizer Metal S...
★★★★☆ 227
\$9.99 -prime

HIGIT 8 Pack Purse Hanger for Closet, Unique Twist Design Bags Hanger Hooks...
★★★★☆ 457
\$7.99 -prime

Antimbee 10-Pack All-Purpose Large Adhesive Hooks for Hanging, Heavy Duty Hold 37 L...
★★★★☆ 7,125
\$9.91 (\$0.99/Count)
-prime
Save \$1.00 with coupon

boost INFINITE







Get iPhone 15 Pro

No trade-in to get started







Order Now

Sponsored

Best Sellers in Home & Kitchen

 <p>Stanley Quencher H2.0 FlowState Stainless Steel Vacuum Insulated Tumbler with Lid and Straw ★★★★★ 30,515 #1 Best Seller in Home & Kitchen \$35.00 Get it as soon as Tuesday, Nov 21 FREE Shipping by Amazon</p>	 <p>Bedsure Satin Pillowcase for Hair and Skin Queen - Silver Grey Silky Pillowcase 20x30 Inch ★★★★★ 296,284 #1 Best Seller in Bed \$6.98 (\$3.49/Count) Get it as soon as Sunday, Nov 19 FREE Shipping on orders over \$35 shipped by Amazon Climate Pledge Friendly</p>	 <p>Queen Size 4 Piece Sheet Set - Comfy Breathable & Cooling Sheets - Hotel Luxury ★★★★★ 292,229 #1 Best Seller in Sheet & Pillowcase Sets \$29.99 Get it as soon as Sunday, Nov 19 FREE Shipping on orders over \$35 shipped by Amazon Climate Pledge Friendly</p>	 <p>Utopia Bedding Throw Pillows Insert (Pack of 2, White) - 18 x 18 Inches Bed and Couch Pillows ★★★★★ 177,011 #1 Best Seller in Throw Pillow Inserts \$16.99 (\$8.50/Count) Get it as soon as Sunday, Nov 19 FREE Shipping on orders over \$35 shipped by Amazon Climate Pledge Friendly</p>	 <p>BISSELL Little Green Multi-Purpose Portable Carpet and Upholstery Cleaner ★★★★★ 65,903 #1 Best Seller in Carpet & Upholstery Cleaning Machines 25% off Deal List: \$129.99 \$89.00 Get it as soon as Sunday, Nov 19 FREE Shipping by Amazon</p>	 <p>Bedsure Fleece Bed Blankets Queen Size Grey - Soft Lightweight ★★★★★ 155,486 #1 Best Seller in Bed Blankets 40% off Deal List: \$69.99 \$20.89 Get it as soon as Monday, Nov 20 FREE Shipping on orders over \$35 shipped by Amazon</p>
--	---	--	--	--	--

Customers who viewed items in your browsing history also viewed

 <p>Purse Hanger Organizer for Closet S Hooks Twist Design Bag Hooks for Hanging ★★★★★ 439 \$8.98 (\$1.12/Count) Get it as soon as Sunday, Nov 19 FREE Shipping on orders over \$35 shipped by Amazon</p>	 <p>12 Pack Purse Hanger for Closet Unique Twist Design Bag Hanger ★★★★★ 1,307 Amazon's Choice in Tie Rack \$9.69 (\$0.81/Count) Get it as soon as Sunday, Nov 19 FREE Shipping on orders over \$35 shipped by Amazon</p>	 <p>BESARME 15 Pack Purse Hanger for Closet, Unique Twist Design Bag Hanger ★★★★★ 314 Amazon's Choice in Utility Hooks \$9.99 (\$0.67/Count) Get it as soon as Sunday, Nov 19 FREE Shipping on orders over \$35 shipped by Amazon</p>	 <p>ZEDODIER 14 Pack Purse Hooks for Closet, Backpack Hanger Bag Hooks, Lashes ★★★★★ 100 \$7.99 (\$0.57/Count) Get it as soon as Sunday, Nov 19 FREE Shipping on orders over \$35 shipped by Amazon</p>	 <p>Myloirena Purse Hangers Bag Hooks Closet - 12 Pack Handbag Hanger ★★★★★ 229 \$9.99 Get it as soon as Sunday, Nov 19 FREE Shipping on orders over \$35 shipped by Amazon</p>	 <p>Fitrice 10 Pack Purse Hanger for Closet, S Hooks for Hanging ★★★★★ 164 \$9.99 (\$1.00/Count) Get it as soon as Monday, Nov 20 FREE Shipping on orders over \$35 shipped by Amazon</p>
--	--	--	--	--	--

See personalized recommendations

[Sign in](#)

New customer? Start here

Back to top

Get to Know Us

- Careers
- Amazon Newsletter
- About Amazon
- Accessibility
- Sustainability
- Press Center
- Investor Relations
- Amazon Devices
- Amazon Science

Make Money with Us

- Sell on Amazon
- Sell apps on Amazon
- Supply to Amazon
- Protect & Build Your Brand
- Become an Affiliate
- Become a Delivery Driver
- Start a Package Delivery Business
- Advertise Your Products
- Self-Publish with Us
- Host an Amazon Hub
- See More Ways to Make Money

Amazon Payment Products

- Amazon Visa
- Amazon Store Card
- Amazon Secured Card
- Amazon Business Card
- Shop with Points
- Credit Card Marketplace
- Reload Your Balance
- Gift Cards
- Amazon Currency Converter

Let Us Help You

- Your Account
- Your Orders
- Shipping Rates & Policies
- Amazon Prime
- Returns & Replacements
- Manage Your Content and Devices
- Your Recalls and Product Safety Alerts
- Help



English United States

Amazon Music
Stream millions of songs

Amazon Ads
Reach customers wherever they spend their time

6pm
Score deals on fashion brands

AbeBooks
Books, art & collectibles

ACX
Audiobook Publishing Made Easy

Sell on Amazon
Start a Selling Account

Amazon Business
Everything For Your Business

Amp
Host your own live radio show with music you love

Amazon Fresh
Groceries & More Right To Your Door

AmazonGlobal
Ship Orders Internationally

Home Services
Experienced Pros. Happiness Guarantee.

Amazon Web Services
Scalable Cloud Computing Services

Audible
Listen to Books & Original Audio Performances

Box Office Mojo
Find Movie Box Office Data

Goodreads
Book reviews & recommendations

IMDb
Movies, TV & Celebrities

IMDbPro
Get Info Entertainment Professionals Need

Kindle Direct Publishing
Indie Digital & Print Publishing Made Easy

Amazon Photos
Unlimited Photo Storage. Free With Prime.

Prime Video Direct
Video Distribution Made Easy

ShopTop Designer Fashion Brands

Amazon Warehouse
Great Deals on Quality Used Products

Whole Foods Market
America's Healthiest Grocery Store

Woot!
Deals and Shenanigans

Zappos
Shoes & Clothing

Ring
Smart Home Security Systems

echo WiFi
Stream 4K Video in Every Room

Black Smart Security for Every Home

Neighbors App
Real-Time Crime & Safety Alerts

Amazon Subscription Boxes
Top subscription boxes - right to your door

PIIPack
Pharmacy Simplified

Amazon Renewed
Like-new products you can trust

EXHIBIT N
Mesiti Declaration
Infringing Product Type 2 Webpages

First Webpage Showing Sale of Infringing
Product Type 2

Home & Kitchen > Storage & Organization > Home Storage Hooks > Utility Hooks

Size Details

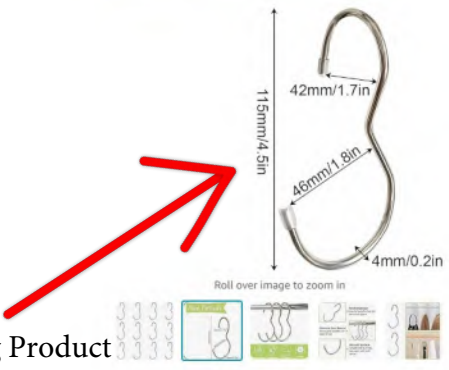

UFURMATE Purse Hanger for Closet, 12Pcs Stainless Steel Unique Twist Design Bags Hanger Heavy Duty S Hooks for Hanging Bags, Handbags, Belts, Scarves, Hats (Silver)

Brand: UFURMATE

\$13.09 (\$1.09 / Count)

Get Fast, Free Shipping with Amazon Prime

FREE Returns

Get a \$60 gift card instantly: Pay \$0.00 \$3.09 upon approval for the Amazon Store Card. Find out how

Brand	UFURMATE
Material	Stainless Steel, Rubber
Product Dimensions	4.53"W x 1.81"H
Special Feature	Heavy Duty
Number of Pieces	12

About this item

- **[Durable Material]** The hook is made of high-quality stainless steel, which is strong and durable, not easy to rust and break, and has a long service life.
- **[Twisted Design]** The twisted design can adjust the hanging angle of your handbag in the wardrobe, which can make better use of the storage space of the wardrobe.
- **[Exquisite Workmanship]** The surface of the hook is smooth and both ends of the hook are wrapped with rubber sleeves for safe use.
- **[Strong Load Bearing]** A single hook can bear a maximum weight of about 10 kg, which can easily hang your backpack or other items.
- **[Wide Application]** Great for hanging wallets, belts, handbags, scarves, towels, potted plants, pots, mugs, wind chimes, bird feeders, indoor and outdoor use.

Evob Stylish, Efficient Storage Solution  Black S Hooks, 30 Pack, Heavy Duty...  11,881 \$7.47 prime

prime Enjoy fast, FREE delivery, exclusive deals and award-winning movies & TV shows with Prime Try Prime and start saving today with Fast, FREE Delivery

\$13.09 (\$1.09 / Count) Get Fast, Free Shipping with Amazon Prime FREE Returns

FREE delivery Friday, November 24 on orders shipped by Amazon over \$35 Or fastest delivery Thursday, November 16. Order within 11 hrs 27 mins

Only 1 left in stock - order soon.

Add to Cart Buy Now

Ships from Amazon Sold by UFURMATE US Returns Returnable until Jan 31, 2024 Payment Secure transaction

Add to List

New (2) from \$13.09 FREE Shipping on orders over \$35.00 shipped by Amazon.

Other Sellers on Amazon

\$18.69 (\$1.56 / Count) Add to Cart & FREE Shipping Sold by: UFURMATE US



Multifunctional Household Hook Set, Black, by Weixinghera... 20 \$12.99 prime

Infringing Product Type 2

Buy it with



Total price: \$38.03

Add all 3 to Cart

Some of these items ship sooner than the others. Show details

This item: UFURMATE Purse Hanger for Closet, 12Pcs Stainless Steel Unique Twist Design Bags... \$13.09 (\$1.09/Count)

Purdaz Corner Shower Caddy, 3 Pack Adhesive Large Caddy with Movable 6 Hooks No Drilling... \$16.99

FYF Over the Door Hooks, 4 Pack Hangers Hooks with Rubber Prevent Scratches Heavy Duty... \$7.95 (\$1.99/Count)

Based on your recent shopping trends

Page 1 of 9



BCISWOS Purse Hanger for Closet, 10 Pack Handbag Hanger...
\$6.99
Typical: \$9.99
Lowest price in 30 days
Get it as soon as Sunday, Nov 19
FREE Shipping on orders over \$35 shipped by Amazon



Fitnice 10 Pack Purse Hooks for Closet, 5 Hooks for Hanging Twisted Purse Hooks...
\$9.99 (\$1.00/Count)
Amazon's Choice in Utility Hooks
Get it as soon as Monday, Nov 20
FREE Shipping on orders over \$35 shipped by Amazon



SAVITA 10pcs Purse Hooks for Closet, Heavy Duty Black S Hooks for Hanging Clothes in a Closet Handbags Twist...
\$11.99 (\$1.20/Count)
Get it as soon as Tuesday, Nov 21
FREE Shipping on orders over \$35 shipped by Amazon
Only 13 left in stock - order...



12 Pack Purse Hangers for Closet, Unique Twisted Purse Hooks, Black Closet Rod S Hooks for Hanging...
\$11.99 (\$1.00/Count)
Get it as soon as Wednesday, Nov 22
FREE Shipping on orders over \$35 shipped by Amazon



HiGift 8 Pack Purse Hanger for Closet, Unique Twist Design...
\$7.99
List: \$9.99
Lowest price in 30 days
Get it as soon as Sunday, Nov 19
FREE Shipping on orders over \$35 shipped by Amazon



12 Pack Purse Hanger for Closet, Twist Design Bag Hanger Purse Hoo...
\$9.99
Typical: \$10.99
Lowest price in 30 days
Get it as soon as Sunday, Nov 19
FREE Shipping on orders over \$35 shipped by Amazon

Overstock deals on Home Storage Hooks Explore more in Outlet

YourGift 30 Pack Heavy Duty S Hooks Black 5 Shaped Hooks Hangin...
★★★★☆ 8,047
50% off Overstock
\$4.24 (\$0.14/Count)
 Typical: ~~\$9.99~~
 Get it as soon as **Monday, Nov 20**
 FREE Shipping on orders over \$35 shipped by Amazon

MCZTO Wall Hooks 22lb(Max) Large Adhesive Hooks 20 Packs, Transparent...
★★★★☆ 22
50% off Overstock
\$6.49 (\$0.65/Count)
 List: ~~\$12.99~~
 Get it as soon as **Tuesday, Nov 21**
 FREE Shipping on orders over \$35 shipped by Amazon

Fashion&cool Towel Hooks, 2 Pack Matte Black SUS304 Stainless Steel Wall Mounted Co...
★★★★☆ 61
50% off Overstock
\$4.99 (\$2.50/Count)
 Typical: ~~\$9.99~~
 Get it as soon as **Tuesday, Nov 28**
 FREE Shipping on orders over \$35 shipped by Amazon
 Only 5 left in stock - order...

Ilyapa Espresso Coat Rack Wall Mount with Shelf - Wood Wall Mount Coat Rack with Shelf, 5...
★★★★☆ 1,792
20% off Overstock
\$27.19
 List: ~~\$55.99~~
 Get it as soon as **Sunday, Nov 19**
 FREE Shipping on orders over \$35 shipped by Amazon
 Only 17 left in stock - orde...

S Shaped Hooks Multi-Function Foldable Hook Set, 4.45 Inch Colored Plastic Hanging Hook...
★★★★☆ 4
30% off Overstock
\$4.89
 Typical: ~~\$6.99~~
 Get it as soon as **Wednesday, Nov 22**
 FREE Shipping on orders over \$35 shipped by Amazon
 Only 16 left in stock - orde...

YES Time Double Prong Ceiling Hooks,6 Piece Under Shelf Coat Hooks Bathroom Hook...
★★★★☆ 3
50% off Overstock
\$5.49
 Typical: ~~\$10.99~~
 Get it as soon as **Monday, Nov 20**
 FREE Shipping on orders over \$35 shipped by Amazon
 Only 19 left in stock - orde...

Videos

Help others learn more about this product by uploading a video!

Upload your video

Looking for specific info?

Search in reviews, Q&A...

Product Description

High-Quality:

The hook is made of high-quality stainless steel, which is strong and durable, not easy to rust and break, and has a long service life. The surface of the hook is smooth and has a black coating, and both ends of the hook are wrapped with rubber sleeves for safe use.

Unique Design:

The twisted design can adjust the hanging angle of your handbag in the wardrobe, which can make better use of the storage space of the wardrobe.

Convenient & Practical:

A single hook can bear a maximum weight of about 10 kg, which can easily hang your backpack or other items.

Versatile:

Great for hanging wallets, belts, handbags, scarves, towels, potted plants, pots, mugs, wind chimes, bird feeders, indoor and outdoor use.

Specification:

- *Material: Stainless Steel
- *Size: 115*46mm
- *Package Content: 12 pcs 5 hooks
- *Weight: 279.6g
- *Color: Silver

Note:

Please allow 1-2mm error due to manual measurement. If you have any questions, please feel free to contact us, thank you very much for your understanding and cooperation!

Product information

Brand	UFURMATE
Material	Stainless Steel, Rubber
Product Dimensions	4.53"W x 1.81"H
Special Feature	Heavy Duty
Number of Pieces	12
Number of Items	12
Item Weight	10.1 ounces
Manufacturer	UFURMATE
ASIN	B09YD1G97D
Item model number	UF-HA0784-G-US
Best Sellers Rank	#495,466 in Industrial & Scientific (See Top 100 in Industrial & Scientific) #5,122 in Utility Hooks #7,934 in Industrial Hooks #229,122 in Hardware
Date First Available	April 20, 2022

Warranty & Support

Product Warranty: For warranty information about this product, please click here

Feedback

Would you like to **tell us about a lower price?** ↕

Important information

To report an issue with this product, [click here](#).



Hanging Hooks Utility, Large Size, Heavy Duty, by Weixinghera...
★★★★★ 20
\$12.99
prime

Sponsored

Similar brands on Amazon

Sponsored

Page 1 of 2

HOME DEPUTY
Shop the Store on Amazon >



HOME DEPUTY 6 Pack Purse Organizers for Closet - 6 Bag Hooks - Silver - Purse...
★★★★★ 511
\$12.50 Typical: \$16.69

Rolly Hanger
Shop the Store on Amazon >



Multipurpose Closet Hanger Organizer ROLLY HANGER Great Space Saver Cut...
★★★★★ 780
\$17.95 List: 600.00

Wisei
Shop the Store on Amazon >



Purse Hanger Organizer for Closet 3 Pack - Durable Luxury Acrylic Holder for...
★★★★★ 449
\$29.99

Customer reviews

No customer reviews



How customer reviews and ratings work

Review this product

Share your thoughts with other customers

Write a customer review

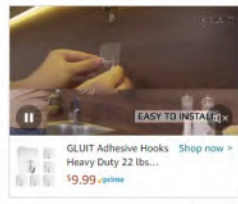

GLIIT Adhesive Hooks Heavy Duty 22 lbs... \$9.99 prime

Sponsored

Customers also viewed these products

Page 1 of 7



Fitrice 10 Pack Purse Hanger for Closet, 5 Hooks for Hanging Twisted Purse Hooks Heavy Duty 5 Hooks...
★★★★★ 184
\$9.99 (\$1.00/Count)
Get it as soon as Monday, Nov 20
FREE Shipping on orders over \$35 shipped by Amazon



ESFUN 30 Pack Heavy Duty 5 Hooks Pan Pot Holder Rack Hooks Hanging Hangers 5 Shaped Hooks for...
★★★★★ 13,549
\$9.99 (\$0.33/Count)
Get it as soon as Sunday, Nov 19
FREE Shipping on orders over \$35 shipped by Amazon



Yzerel 12Pcs 5 Hooks Hanging Safety Buckle - 3.5 inch Heavy Duty 5 Hooks, Hanging Plants for Closet Hooks...
★★★★★ 315
\$6.12 (\$0.51/Pc)
Get it as soon as Sunday, Nov 19
FREE Shipping on orders over \$35 shipped by Amazon



FSAH 17 Pcs 5 Hooks for Hanging Safety Buckle...
★★★★★ 331
Amazon's Choice in Utility Hooks
Save 42%
\$6.99 (\$0.41/Count)
Typical: \$11.99
Lowest price in 30 days
Get it as soon as Sunday, Nov 19
FREE Shipping on orders over \$35 shipped by Amazon



MEILDY 5 Hooks, Reversible Black S Shaped Hooks 3 Inch Small Heavy Duty Stainless Steel S...
★★★★★ 107
\$9.99
Get it as soon as Sunday, Nov 19
FREE Shipping on orders over \$35 shipped by Amazon



Fadilo 6 Pack 6 Inch White S Hook, Large Vinyl Coated 5 Hooks with Rubber Stopper...
★★★★★ 2,800
Amazon's Choice in Screw-In Hooks
\$7.99 (\$1.33/Count)
Get it as soon as Sunday, Nov 19
FREE Shipping on orders over \$35 shipped by Amazon



Hanging Hooks Utility, Large Size, Heavy Duty, by Weixinghera...
★★★★★ 20
\$12.99
prime

Sponsored

Best Sellers in Kitchen & Dining Page 1 of 6



Stanley Quencher H2.0 FlowState Stainless Steel Vacuum Insulated Tumbler with Lid and Straw
★★★★★ 30,514
#1 Best Seller in Home & Kitchen
\$35.00
 Get it as soon as **Wednesday, Nov 22**
 FREE Shipping by Amazon



Owala FreeSip Insulated Stainless Steel Water Bottle with Straw for Sports and Travel, BPA-Free
★★★★★ 26,933
#1 Best Seller in Travel & To-Go Drinkware
\$24.97
 Get it as soon as **Sunday, Nov 19**
 FREE Shipping on orders over \$35 shipped by Amazon



Stanley IceFlow Stainless Steel Tumbler with Straw, Vacuum Insulated Water Bottle for Home, Office or Car, Reusable
★★★★★ 18,907
\$35.00
 Get it as soon as **Sunday, Nov 19**
 FREE Shipping by Amazon



Alpha Grillers Instant Read Meat Thermometer for Grill and Cooking
★★★★★ 56,291
#1 Best Seller in Patio, Lawn & Garden
\$15.99
 Get it as soon as **Sunday, Nov 19**
 FREE Shipping on orders over \$55 shipped by Amazon



Simple Modern 40 oz Tumbler with Handle and Straw Lid | Insulated Cup Reusable Stainless Steel Water Bottle
★★★★★ 23,957
\$29.99
 Get it as soon as **Sunday, Nov 19**
 FREE Shipping on orders over \$35 shipped by Amazon



Vegetable Chopper, Pro Onion Chopper, Multifunctional 13 in 1
★★★★★ 15,586
#1 Best Seller in Seasoning & Spice Choppers
50% off Deal
\$17.08
 List: \$33.99
 Get it as soon as **Sunday, Nov 19**
 FREE Shipping on orders over \$35 shipped by Amazon

Customers who viewed items in your browsing history also viewed Page 1 of 6



12 Pack Purse Hanger for Closet, Unique Twist Design Bag Hanger Purse Hooks, Large Size Closet
★★★★★ 1,307
Amazon's Choice in Tie Racks
\$9.69 (\$0.81/Count)
 Get it as soon as **Sunday, Nov 19**
 FREE Shipping on orders over \$35 shipped by Amazon



Purse Hanger Organizer for Closet, 5 Hooks Twist Design Bag Hanger, Closet Rod Hooks for Hanging
★★★★★ 439
\$18.98 (\$1.12/Count)
 Get it as soon as **Sunday, Nov 19**
 FREE Shipping on orders over \$35 shipped by Amazon



BESARME 15 Pack Purse Hanger for Closet, Unique Twist Design Bag Hanger Hooks, Purse
★★★★★ 314
Amazon's Choice in Utility Hooks
\$9.99 (\$0.67/Count)
 Get it as soon as **Sunday, Nov 19**
 FREE Shipping on orders over \$35 shipped by Amazon



Fitrice 10 Pack Purse Hanger for Closet, 5 Hooks for Hanging Twisted Purse Hooks Heavy Duty S Hooks
★★★★★ 184
\$9.99 (\$1.00/Count)
 Get it as soon as **Monday, Nov 20**
 FREE Shipping on orders over \$35 shipped by Amazon



ZEDODIER 14 Pack Purse Hooks for Closet, Backpack Hanger Bag Holder, Closet Accessories Organizer
★★★★★ 100
\$7.99 (\$0.57/Count)
 Get it as soon as **Sunday, Nov 19**
 FREE Shipping on orders over \$35 shipped by Amazon



Myfolrenea Purse Hangers Bag Hooks Closet- 12 Pack Handbag Hanger Organizer Metal S Hooks, Large Size Closet
★★★★★ 229
\$9.99
 Get it as soon as **Sunday, Nov 19**
 FREE Shipping on orders over \$35 shipped by Amazon

See personalized recommendations

[Sign in](#)

New customer? Start here.

Back to top

Get to Know Us

- Careers
- Amazon Newsletter
- About Amazon
- Accessibility
- Sustainability
- Press Center
- Investor Relations
- Amazon Devices
- Amazon Science

Make Money with Us

- Start Selling with Amazon
- Sell apps on Amazon
- Supply to Amazon
- Protect & Build Your Brand
- Become an Affiliate
- Become a Delivery Driver
- Start a Package Delivery Business
- Advertise Your Products
- Self-Publish with Us
- Host an Amazon Hub
- See More Ways to Make Money

Amazon Payment Products

- Amazon Visa
- Amazon Store Card
- Amazon Secured Card
- Amazon Business Card
- Shop with Points
- Credit Card Marketplace
- Reload Your Balance
- Gift Cards
- Amazon Currency Converter

Let Us Help You

- Your Account
- Your Orders
- Shipping Rates & Policies
- Amazon Prime
- Returns & Replacements
- Manage Your Content and Devices
- Your Recalls and Product Safety Alerts
- Help

amazon

English United States

Amazon Music
Stream millions of songs

Amazon Ads
Reach customers wherever they spend their time

6pm
Score deals on fashion brands

AbeBooks
Books, art & collectibles

ACX
Audiobook Publishing Made Easy

Sell on Amazon
Start a Selling Account

Amazon Business
Everything For Your Business

Amp
Host your own live radio show with music you love

Amazon Fresh
Groceries & More Right To Your Door

Amazon Global
Ship Orders Internationally

Home Services
Experienced Pros. Happiness Guarantee

Amazon Web Services
Scalable Cloud Computing Services

Audible
Listen to Books & Original Audio Performances

Box Office Mojo
Find Movie Box Office Data

Goodreads
Book reviews & recommendations

IMDb
Movies, TV & Celebrities

IMDbPro
Get Info Entertainment Professionals Need

Kindle Direct Publishing
 indie Digital & Print Publishing Made Easy

Amazon Photos
Unlimited Photo Storage Free With Prime

Prime Video
Direct Video Distribution Made Easy

Shopbop
Designer Fashion Brands

Amazon Warehouse
Great Deals on Quality Used Products

Whole Foods Market
America's Healthiest Grocery Store

Woot!
Deals and Showmings

Zappos
Shoes & Clothing

Ring
Smart Home Security Systems

eero WiFi
Stream 4K Video in Every Room

Blink
Smart Security for Every Home

Neighbors
App
Real-Time
Crime
& Safety
Alerts

Amazon Subscription
Boxes
Top subscription boxes
— right to your door

PillPack
Pharmacy
Simplified

Amazon
Renewed
Like-new
products
you can trust

[Conditions of Use](#) [Privacy Notice](#) [Your Ads Privacy Choices](#) 

© 1996-2023, Amazon.com, Inc. or its affiliates

Second Webpage Showing Sale of
Infringing Product Type 2

Organize your space with GLUIT **\$12.99** prime
GLUIT Adhesive Hooks Heavy Duty 22 lbs Robe Towel Hooks Waterproof Adhesive Wall Hooks for Home Bathroom Kitchen Office and Outdoor 12 Pack

Home & Kitchen > Storage & Organization > Home Storage Hooks > Utility Hooks

Product size



Infringing Product Type 2

BESARME 30 Pack Purse Hanger for Closet, Purse Hooks Organizer Unique Twist Design Bag Hanger Hooks S Hooks for Hanging Handbags Purses Belts Scarves Hats Clothes 3.5Inch(Black)

Brand: BESARME
4.6 ★★★★★ 54 ratings

-9% **\$19.99** (\$0.67 / Count)
List Price: \$21.99

Get Fast, Free Shipping with Amazon Prime
FREE Returns

Best price

Get a \$60 gift card instantly. Pay \$0.00 \$19.99 upon approval for the Amazon Store Card. Find out how

Color: Black
Material: Stainless Steel, Metal
Brand: BESARME
Item Weight: 30 Grams
Mounting Type: Hanging

About this item

- **[Sturdy Material]** Our purse hooks are made of stainless steel and both ends of the hook are covered with soft rubber, hard and sturdy, not easy to be damaged or deformed and there is no need to worry about rust when using outdoors. All the bag hooks are coated with a rubber tip on the ends to protect your handbag straps.
- **[Unique Space-saving Design]** We improved the classical regular S hook and twisted it 90°, let your handbag be better displayed. These purse hooks are perfect to give the correct orientation to hang well, save more spaces to store more bags in your closet also you will choose and organize handbags more convenient.
- **[Large Size Purse Hanger]** Each package including 30packs black handbag hangers. H - 4.5 inches, W - 1.6 inches, it fits all closet rods less than 1.6inches. Each wallet hanger weight 30g, light and portable, but strong enough to hold items up to 5kg.
- **[Widely Applications]** These purse hooks can be used for many things, it can also be used to organize various clothing accessories or tools, display plants or organize kitchen utensils, tidy your various accessories or tools such as handbags, belts, ties, jeans, tops, boots, scarves, plants, pots and pans, wind chimes, bird feeders and more for indoor and outdoor use. It is your perfect space saving helper.
- **[Easy to Use]** Not require to use nails, screws, or adhesives, our handbag hooks are easy to hang on existing objects. Great for hanging bags to keep your handbag in perfect shape.

Customer ratings by feature

Easy to use ★★★★★ 5.0
 Sturdiness ★★★★★ 5.0
 Value for money ★★★★★ 5.0
 See all reviews

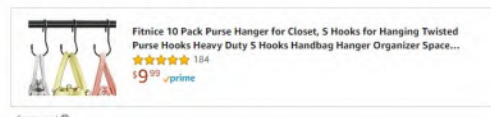

prime
Enjoy fast, FREE delivery, exclusive deals and award-winning movies & TV shows with Prime
Try Prime and start saving today with Fast, FREE Delivery

\$19.99 (\$0.67 / Count)
Get Fast, Free Shipping with Amazon Prime
FREE Returns
FREE delivery Sunday, November 19 on orders shipped by Amazon over \$35

Or fastest delivery Thursday, November 16. Order within 11 hrs 27 mins

Delivering to Albany 12201 - Update location

In Stock
Qty: 1
Add to Cart
Buy Now

Ships from Amazon
Sold by zhangheting
Returns Returnable until Jan 31, 2024
Payment Secure transaction
See more
 Add a gift receipt for easy returns
Add to List



Frequently bought together



Total price: **\$27.46**
Add both to Cart

These items are shipped from and sold by different sellers. Show details

4 stars and above

Sponsored

★★★★★ 100 \$7.99 (\$0.57/Count) prime	★★★★★ 296 \$9.99 (\$0.83/Count) prime	★★★★★ 184 \$9.99 (\$1.00/Count) prime	★★★★★ 227 \$9.99 prime	★★★★★ 519 \$6.99 (\$0.41/Count) prime	★★★★★ 457 \$7.99 prime	★★★★★ 2,106 \$8.99 (\$0.75/Count) prime

Products related to this item

Sponsored

★★★★★ 17 \$9.98 (\$0.50/Count) prime	★★★★★ 42 \$11.99 prime	★★★★★ 37 \$9.99 (\$0.83/Count) prime	★★★★★ 30 \$13.99 prime	★★★★★ 519 \$6.99 (\$0.41/Count) prime	★★★★★ 30 \$6.99 prime	★★★★★ 1 \$15.99 prime

Product Description



Are you always troubled by the bag being not being placed neatly?

Our purse hooks may be of great help to you!

It's hard to say no to a neat closet!

- Saving more space to store more bags in your closet.

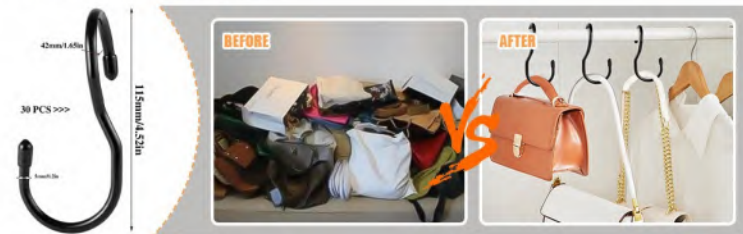

Easy to Use

- Not require to use tools, nails, screws, or adhesives, our handbag hooks are easy to hang on existing objects. Great for hanging handbags to keep them in perfect shape.

► About Our Products

Material: High quality stainless steel material with rubber coated on surface.

► Why Choose Us

- ✓ Thoughtful rubber cover design, no need to worry about rusting even in outdoor use.
- ✓ Hard and sturdy, not easily damaged or deformed.



Unique Twist Design for Better Organized

- These hangers are perfect for providing a suitable orientation for your handbag, making it easier to organize and remove your handbag, keeps your bags neatly organized!



More Than Just A Purse Hanger

- It can also be used to organize various clothing accessories or tools, as well as belts, handbags, ties, jeans, scarves, towels, and so on.



Multiple use

Wide range of uses

- For hanging pots and pans, cups, bird feeders, birdhouses, display plants, flowerpots, or organizing kitchen utensils. It is your perfect space-saving helper.



15 Packs Purse Hanger for Closet

30 Packs Purse Hanger for Closet

Unique Space-saving Design	✓	✓
Sturdy Material	✓	✓
Wide range of uses	✓	✓

Looking for specific info?

Product information

Technical Details

Manufacturer	BESARME
Item Weight	1.06 ounces
Package Dimensions	6.69 x 4.92 x 2.87 inches
Size	30 Pack
Color	Black
Style	Classic
Finish	Stainless Steel
Material	Stainless Steel, Metal
Number Of Pieces	30
Maximum Weight Capacity	5 Kilograms
Mounting Type	Hanging
Special Features	Portable
Batteries Required?	No

Additional Information

ASIN	B0BFHHBT38
Customer Reviews	4.6 ★★★★★ 54 ratings 4.6 out of 5 stars
Best Sellers Rank	#32,459 in Home & Kitchen (See Top 100 in Home & Kitchen) #177 in Utility Hooks
Date First Available	September 18, 2022

Warranty & Support

Product Warranty: For warranty information about this product, please click here

Feedback

Would you like to [tell us about a lower price?](#)

Videos

Videos for related products

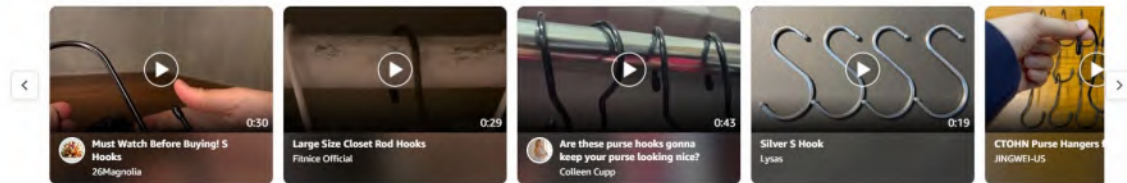

Upload your video

Compare with similar items

This Item BESARME 30 Pack Purse Hanger for Closet, Purse Hooks Organizer Unique Twist Design Bag Hanger Hooks 5 Hooks for Hanging Handbags Purse Belts Scarves Hats Clothes 3.5Inch(Black)	BESARME 15 Pack Purse Hanger for Closet, Unique Twist Design Bag Hanger Hooks, Purse Organizer Hooks for Closet Large Closet 5 Hooks for Hanging Handbags Purse Clothes(Black)	Purse Hanger Purse Organizer for Closet, 5 Hooks Twist Design Bag Hanger, Closet Rod Hooks for Hanging Handbags, Purse, Belts, Scarves, Hats, Clothes, Pots and Pans. (8 Pack Black)	Myfolrenea Purse Hangers Bag Hooks Closet- 12 Pack Handbag Hanger Organizer Metal 5 Hooks, Large Size Closet Rod Hooks for Hanging Handbags, Clothes, Curtain, Plant, Pans and Pots	ZEDODIER 14 Pack Purse Hooks for Closet, Backpack Hanger Bag Holder, Closet Accessories Organizer 5 Hook for Hanging Purse, Handbags, Bags, Belts, Scarves, Hats, Clothes, and Plant, Silver
Add to Cart	Add to Cart	Add to Cart	Add to Cart	Add to Cart
Customer Rating ★★★★★ (54)	Customer Rating ★★★★★ (314)	Customer Rating ★★★★★ (439)	Customer Rating ★★★★★ (229)	Customer Rating ★★★★★ (100)
Price \$19 ⁹⁹	Price \$9 ⁹⁹	Price \$8 ⁹⁸	Price \$9 ⁹⁹	Price \$7 ⁹⁹
Shipping FREE Shipping on orders over \$35.00 shipped by Amazon or get Fast, Free Shipping with Amazon Prime	Shipping FREE Shipping on orders over \$35.00 shipped by Amazon or get Fast, Free Shipping with Amazon Prime	Shipping FREE Shipping on orders over \$35.00 shipped by Amazon or get Fast, Free Shipping with Amazon Prime	Shipping FREE Shipping on orders over \$35.00 shipped by Amazon or get Fast, Free Shipping with Amazon Prime	Shipping FREE Shipping on orders over \$35.00 shipped by Amazon or get Fast, Free Shipping with Amazon Prime
Sold By zhangheting	Sold By zhangheting	Sold By NEZA-US	Sold By Myfolrenea Official	Sold By ZEDODIER
Color Black	Color Black	Color Black	Color Silver	Color Silver
Material Stainless Steel, Metal	Material Vinyl	Material Metal, Vinyl	Material Stainless Steel, Metal	Material Metal

Videos for this product



Important information

To report an issue with this product, click here.

Products related to this item

Page 1 of 20

Sponsored

Zanon 50 Pack S Shaped Hooks for Hanging Heavy Duty Metal Ornament S Clip 3.8...
★★★★★ 2
\$27.99 [prime](#)

HomeyHandcraft 8 Pack 6 Inch Rattan S Hooks for Hanging, Hangers 5 Shaped Hooks for...
★★★★★ 33
\$24.99 (E5.12/Count) [prime](#)

ZEDODIER 14 Pack Purse Hooks for Closet, Backpack Hanger Bag Holder, Closet Accesso...
★★★★★ 100
\$7.99 [prime](#)

30 Pack S Hooks, 3.54 In Matte Black Heavy Duty Metal S Hooks Can with Stand up to 3...
★★★★★ 2,499
\$8.99 (\$0.30/Count) [prime](#)
[Save 5%](#) with coupon

CTOHN 20 Pack Purse Hanger for Closet, Unique Twist Design Bag Hanger Purse Hooks, ...
★★★★★ 17
\$9.98 (\$0.50/Count) [prime](#)

Purse Hangers 16 Pack Bag Hooks, Twist Shape Purse Hooks for Closet, Large Size Clo...
★★★★★ 42
\$11.99 [prime](#)

FSAH 17 Pcs S Hooks for Hanging Safety Buckle, 3.5 Inch Stainless Steel S Shaped Lo...
★★★★★ 519
\$6.99 (\$0.41/Count) [prime](#)

Sponsored

Lilo Visa Vinyl Coated Hook For Hanging

12 Pack Purse Hanger for Closet, Unique Twist Design Bag Hanger Purse Hooks, Large Size Closet Rod...
★★★★★ 1,307
\$9⁹⁹ [prime](#)

Similar brands on Amazon

Sponsored

Page 1 of 2

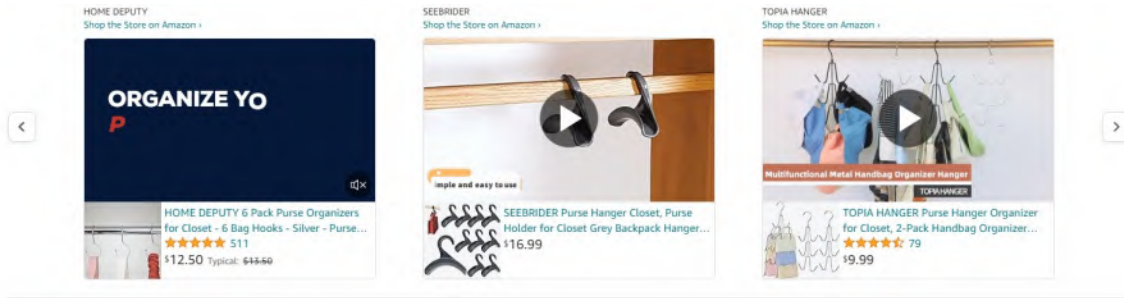

Customer reviews

4.6 out of 5

54 global ratings

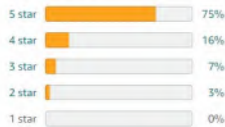

How customer reviews and ratings work

By feature

- Easy to use 5.0
Sturdiness 5.0
Value for money 5.0

Review this product

Share your thoughts with other customers

Write a customer review

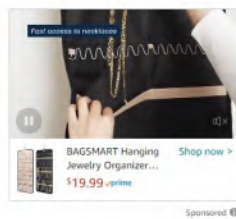

Top reviews

Top reviews from the United States

Translate all reviews to English

PDT1575 Found what I was looking for. Reviewed in the United States on October 2, 2023. Color: Black Size: 30 Pack Verified Purchase. Quite versatile and durable. Very convenient for multiple items, including purses, hats, bags, etc.

Ronnette Purse hooks. Reviewed in the United States on August 13, 2023. Color: Black Size: 30 Pack Verified Purchase. This is a nice sturdy product and works amazing in your closets for multiple item to include purses, hats, belt etc. I would recommend this product. You get the value for your money.

LK Best organizer ever. Reviewed in the United States on August 31, 2023. Color: Black Size: 30 Pack Verified Purchase. 100% worth it to organize a closet. Heavy duty and worth the \$

Mary gilbert Works great. Reviewed in the United States on September 9, 2023. Color: Black Size: 30 Pack Verified Purchase. Works great







D. Owen Just what I needed. Reviewed in the United States on February 15, 2023. Color: Black Size: 30 Pack Verified Purchase. These 5 hooks worked great for hanging up my purses to sell. No more taking all of them off the rod to get to one. They also worked great for multiple things to display. I'm going to order more sets so my husband can hang his lights around our trailer when we go camping. Wish they came in Pink is all.

Annelis Wow demasiado práctico y genial. Reviewed in the United States on January 18, 2023. Color: Black Size: 30 Pack Verified Purchase. Realmente me agradaron estos ganchos, quedaron en la posición perfecta que yo necesitaba para acomodar bolsos y quedarán de lado y bien organizadas. Muchas gracias

TQ Hanging bags. Reviewed in the United States on June 1, 2023. Color: Black Size: 30 Pack Verified Purchase. We used these to hang purses and bags on a hang bar, so they are easy to see. They work great.









See more reviews

Based on your recent shopping trends









 <p>BCISIWOS Purse Hanger for Closet, 10 Pack Handbag Hanger... ★★★★★ 30 Save 8% \$6.99 Typical: \$9.99 Lowest price in 30 days Get it as soon as Sunday, Nov 19 FREE Shipping on orders over \$35 shipped by Amazon</p>	 <p>Fitnice 10 Pack Purse Hanger for Closet, 5 Hooks for Hanging Twisted Purse Hooks... ★★★★★ 184 Amazon's Choice in Utility Hooks \$9.99 (\$1.00/Count) Get it as soon as Monday, Nov 20 FREE Shipping on orders over \$35 shipped by Amazon</p>	 <p>GEZIDEA Purse Hanger 5 Hooks Twisted 5 Hooks Closet Rod Hooks for Handbags,Bags,Clothes,P... ★★★★★ 355 ★★★★★ 107</p>	 <p>MELIDY 5 Hooks, Reversible Black S Shaped Hooks 3 Inch Small Heavy Duty Stainless Steel S... ★★★★★ 107 \$9.99 Get it as soon as Sunday, Nov 19 FREE Shipping on orders over \$35 shipped by Amazon</p>	 <p>10PCS 5 Hooks for Hanging - Twist Design Anti-Drop Stainless Steel Metal Hangers Hanging Hooks, for Kitchen, Wo... ★★★★★ 409 \$12.99 (\$3.71/43/Count) Get it as soon as Monday, Nov 20 FREE Shipping on orders over \$35 shipped by Amazon</p>	 <p>Riveky 10 Pack Black S Hooks for Hanging Plants, S Hooks for Hanging Clothes, Stainless Steel S Hook... ★★★★★ 4,675 \$4.99 (\$0.50/Count) Get it as soon as Tuesday, Nov 21 FREE Shipping on orders over \$35 shipped by Amazon</p>	 <p>30 Pack S Hooks for Hanging, 3.15 inch Stainless Steel S Shaped Hooks Curtain Hooks Heavy Duty S Hooks fo... ★★★★★ 36 \$12.99 Get it as soon as Sunday, Nov 19 FREE Shipping on orders over \$35 shipped by Amazon</p>
--	--	--	--	--	---	--

Fitnice 10 Pack Purse Hanger for Closet, 5 Hooks for Hanging Twisted Purse Hoo...
★★★★★ 184
\$9.99 prime
Sponsored

Best Sellers in Home & Kitchen

 <p>Stanley Quencher H2.O FlowState Stainless Steel Vacuum Insulated Tumbler with Lid and... ★★★★★ 30,514 #1 Best Seller in Home & Kitchen \$35.00 Get it as soon as Wednesday, Nov 22 FREE Shipping by Amazon</p>	 <p>Bedure Satin Pillowcase for Hair and Skin Queen - Silver Grey Silky Pillowcase 20x30 Inch... ★★★★★ 296,284 #1 Best Seller in Bed Pillow Pillowcases \$6.98 (\$1.49/Count) Get it as soon as Sunday, Nov 19 FREE Shipping on orders over \$35 shipped by Amazon Climate Pledge Friendly</p>	 <p>Queen Size 4 Piece Sheet Set - Comfy Breathable & Cooling Sheets - Hotel Luxury Bed Sheets for... ★★★★★ 292,228 #1 Best Seller in Sheet & Pillowcase Sets \$29.99 Get it as soon as Sunday, Nov 19 FREE Shipping on orders over \$35 shipped by Amazon Climate Pledge Friendly</p>	 <p>Utopia Bedding Throw Pillows Insert (Pack of 2, White) - 18 x 18 Inches Bed and Couch Pillows... ★★★★★ 177,010 #1 Best Seller in Throw Pillow Inserts \$16.99 (\$8.50/Count) Get it as soon as Sunday, Nov 19 FREE Shipping on orders over \$35 shipped by Amazon Climate Pledge Friendly</p>	 <p>BISSELL Little Green Multi-Purpose Portable Carpet and Upholstery... ★★★★★ 65,003 #1 Best Seller in Carpet & Upholstery Cleaning Machines 78% off Deal \$89.00 List: \$429.99 Get it as soon as Sunday, Nov 19 FREE Shipping by Amazon</p>	 <p>Bedure Fleece Bed Blankets Queen Size Grey - Soft Lightweight... ★★★★★ 155,486 #1 Best Seller in Bed Blankets 48% off Deal \$20.89 List: \$99.99 Get it as soon as Monday, Nov 20 FREE Shipping on orders over \$35 shipped by Amazon</p>	 <p>Utopia Bedding Queen Bed Sheets Set - 4 Piece Bedding - Brushed Microfiber - Shrinkage and Fade Resistant... ★★★★★ 161,476 \$21.95 Get it as soon as Sunday, Nov 19 FREE Shipping on orders over \$35 shipped by Amazon Climate Pledge Friendly</p>	 <p>Amazon Basics Lightweight Super Soft Easy Care Microfiber 3-Piece Bed Sheet Set with 14-Inch Deep Pockets... ★★★★★ 474,678 \$15.91 (\$5.30/Count) Get it as soon as Sunday, Nov 19 FREE Shipping on orders over \$35 shipped by Amazon Climate Pledge Friendly</p>	 <p>Barossa Design Plastic Shower Liner Clear - Premium PEVA Shower... ★★★★★ 48,883 #1 Best Seller in Shower Curtain Liners \$8.95 Get it as soon as Sunday, Nov 19 FREE Shipping on orders over \$35 shipped by Amazon</p>
---	---	---	--	--	--	---	--	--

Customers who viewed items in your browsing history also viewed

 <p>12 Pack Purse Hanger for Closet, Unique Twist Design Bag Hanger Purse Hooks, Large Size Clos... ★★★★★ 1,307 Amazon's Choice in Tie Racks \$9.69 (\$0.81/Count) Get it as soon as Sunday, Nov 19 FREE Shipping on orders over \$35 shipped by Amazon</p>	 <p>Purse Hanger Purse Organizer for Closet, 5 Hooks Twist Design Bag Hanger, Closet Rod Hooks for Hanging... ★★★★★ 439 \$8.98 (\$1.12/Count) Get it as soon as Sunday, Nov 19 FREE Shipping on orders over \$35 shipped by Amazon</p>	 <p>Fitnice 10 Pack Purse Hanger for Closet, 5 Hooks for Hanging Twisted Purse Hooks Heavy Duty 5 Hooks... ★★★★★ 184 \$9.99 (\$1.00/Count) Get it as soon as Monday, Nov 20 FREE Shipping on orders over \$35 shipped by Amazon</p>	 <p>ZEDODIER 14 Pack Purse Hooks for Closet, Backpack Hanger Bag Holder, Closet Accessories Organizer... ★★★★★ 100 \$7.99 (\$0.57/Count) Get it as soon as Sunday, Nov 19 FREE Shipping on orders over \$35 shipped by Amazon</p>	 <p>BESARME 15 Pack Purse Hanger for Closet, Unique Twist Design Bag Hanger Hooks, Purse... ★★★★★ 314 Amazon's Choice in Utility Hooks \$9.99 (\$0.67/Count) Get it as soon as Sunday, Nov 19 FREE Shipping on orders over \$35 shipped by Amazon</p>	 <p>Myfolrenea Purse Hangers Bag Hooks Closet- 12 Pack Handbag Hanger Organizer Metal S Hooks, Large Size Clos... ★★★★★ 229 \$9.99 Get it as soon as Sunday, Nov 19 FREE Shipping on orders over \$35 shipped by Amazon</p>	 <p>GEZIDEA Purse Hanger 5 Hooks Twisted 5 Hooks Closet Rod Hooks for Handbags,Bags,Clothes,P... ★★★★★ 353</p>	 <p>CTOHN 20 Pack Purse Hanger for Closet, Unique Twist Design Bag Hanger Purse Hooks, Purse Organizer Hooks... ★★★★★ 17 \$9.98 (\$0.50/Count) Get it as soon as Sunday, Nov 19 FREE Shipping on orders over \$35 shipped by Amazon</p>	 <p>MELIDY 5 Hooks, Reversible Black S Shaped Hooks 3 Inch Small Heavy Duty Stainless Steel S... ★★★★★ 107 \$9.99 Get it as soon as Sunday, Nov 19 FREE Shipping on orders over \$35 shipped by Amazon</p>
--	--	---	---	--	--	--	---	--

See personalized recommendations

Sign in

New Customer? Start here.

Back to top

Get to Know Us

- Careers
- Amazon Newsletter
- About Amazon
- Accessibility
- Sustainability
- Press Center
- Investor Relations
- Amazon Devices
- Amazon Science

Make Money with Us

- Start Selling with Amazon
- Sell apps on Amazon
- Supply to Amazon
- Protect & Build Your Brand
- Become an Affiliate
- Become a Delivery Driver
- Start a Package Delivery Business
- Advertise Your Products
- Self-Publish with Us
- Host an Amazon Hub

Amazon Payment Products

- Amazon Visa
- Amazon Store Card
- Amazon Secured Card
- Amazon Business Card
- Shop with Points
- Credit Card Marketplace
- Reload Your Balance
- Gift Cards
- Amazon Currency Converter

Let Us Help You

- Your Account
- Your Orders
- Shipping Rates & Policies
- Amazon Prime
- Returns & Replacements
- Manage Your Content and Devices
- Your Recalls and Product Safety Alerts
- Help

See More Ways to Make Money

amazon

English

United States

Amazon Music
Stream millions of songs.

Amazon Ads
Reach customers wherever they spend their time.

Epm
Score deals on fashion brands.

AbeBooks
Books, art & collectibles.

ACX
Audiobook Publishing Made Easy

Sell on Amazon
Start a Selling Account

Amazon Business
Everything For Your Business

Amp
Host your own live radio show with music you love.

Amazon Fresh
Groceries & More Right To Your Door

AmazonGlobal
Ship Orders Internationally

Home Services
Experienced Pros. Happiness Guarantee.

Amazon Web Services
Scalable Cloud Computing Services

Audible
Listen to Books & Original Audio Performances

Box Office Mojo
Fast Movie Box Office Data

Goodreads
Book reviews & recommendations

IMDb
Movies, TV & Celebrities

IMDbPro
Get Info Entertainment Professionals Need

Kindle Direct Publishing
Publish in Kindle Digital & Print Publishing Made Easy

Amazon Photos
Unlimited Photo Storage Free With Prime

Prime Video Direct
Video Distribution Made Easy

Shopbop
Designer Fashion Brands

Amazon Warehouse
Great Deals on Quality Used Products

Whole Foods Market
America's Healthiest Grocery Store

Woot!
Deals and Shenanigans

Zappos
Shoes & Clothing

Ring
Smart Home Security Systems

eero WiFi
Stream 4K Video in Every Room

Blink
Smart Security for Every Home

Neighbors App
Real-Time Crime & Safety Alerts

Amazon Subscription Boxes
Top subscription boxes - right to your door

PillPack
Pharmacy Simplified

Amazon Renewed
Like-new products you can trust

EXHIBIT O
Mesiti Declaration
Infringing Product Type 3 Webpages

First Webpage Showing Sale of Infringing
Product Type 3

Organize your space with GLUIT GLUIT Adhesive Hooks Heavy Duty 22 lbs Robe Towel Hooks Waterproof Adhesive Wall Hooks for Home Bathroom Kitchen Office and Outdoor 12 Pack \$12.99



AccEncyc 12 Pcs Purse Hanger Closet Bag Hooks Handbag Organizer Heavy Duty S Hooks for Hanging Purse for Closet and Shower Stainless Steel (Silver)

Brand: AccEncyc 4.6 ★★★★★ 6 ratings

\$4.59 (\$0.38 / Count)

Get Fast, Free Shipping with Amazon Prime 5 Best price

Get a \$60 gift card instantly. Pay \$0.00 \$4.59 upon approval for the Amazon Store Card. Find out how

Color: Silver \$4.59 (\$0.38 / Count)

Color: Silver
Material: Stainless Steel
Brand: AccEncyc
Mounting Type: Desk Mount
Maximum Weight Recommendation: 40 Pounds

About this item

- Include: 12 pack 5 hooks for hanging purses, bags, ties and so on. Measurement: approx. 4 inches, 3.5mm in thickness.
- Stainless Steel: Made of stainless steel, so these hooks will not get rusty. Great to be used in closet and bathroom.
- Heavy Duty: The thickness of the hooks are 3.5mm. They can load up to 40 lb weights, very durable for daily uses.
- 90 Degree S hooks: Special designed for hanging purses and handbags, the 90 degree hooks will hold your purses and bags in a very neatly way in the closet.
- Widely Used Utility Hooks: Except for holding purses, these hooks are also very useful for hanging kitchenware, coat and hat, ties, belts, wreathes and so on.

prime Enjoy fast, FREE delivery, exclusive deals and award-winning movies & TV shows with Prime. Try Prime and start saving today with Fast, FREE Delivery

\$4.59 (\$0.38 / Count)

Get Fast, Free Shipping with Amazon Prime

FREE delivery Sunday, November 19 on orders shipped by Amazon over \$35

Or fastest delivery Friday, November 17. Order within 10 hrs 50 mins

Delivering to Albany 12201 - Update location

Only 16 left in stock - order soon.

Qty: 1

Add to Cart Buy Now

Ships from Amazon Sold by AccEncyc US Returns Returnable until Jan 31, 2024

Payment Secure transaction Add a gift receipt for easy returns

Add to List

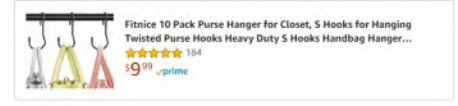

Sponsored



Sponsored

Buy it with



Total price: \$34.57 Add all 3 to Cart

Some of these items ship sooner than the others. Show details

This item: AccEncyc 12 Pcs Purse Hanger Closet Bag Hooks Handbag Organizer Heavy Duty ... \$4.59 (\$0.38/Count)
EZlifeego Double Sided Tape Heavy Duty, Extra Large Nano Double Sided Adhesive Tape, Clear... \$19.99 (\$0.08/Item)
EUDELE Shower Caddy 5 Pack Adhesive Shower Organizer for Bathroom Storage&Kitchen... \$19.99

Products related to this item

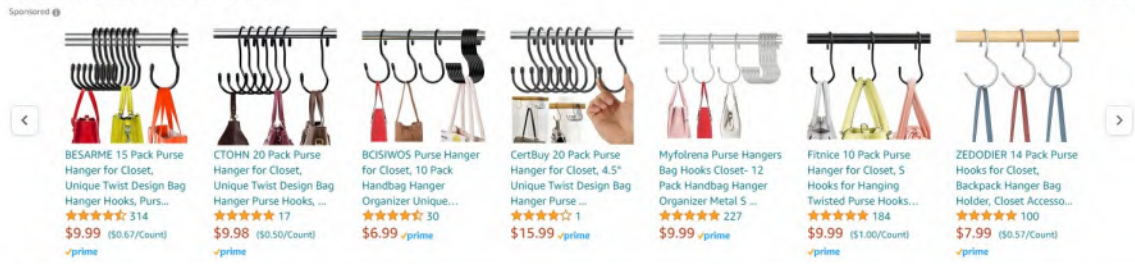

Based on your recent shopping trends

- BCISIWOS Purse Hanger for Closet, 10 Pack Handbag Hanger...**
 - Save 8%
 - ★ ★ ★ ★ ★ 30
 - \$6.99
 - Typical: ~~\$7.99~~
 - Lowest price in 30 days
 - Get it as soon as **Sunday, Nov 19**
 - FREE Shipping on orders over \$35 shipped by Amazon
- Fitnice 10 Pack Purse Hanger for Closet, 5 Hooks for Hanging Twisted Purse Hooks...**
 - Amazon's Choice in Utility Hooks
 - ★ ★ ★ ★ ★ 184
 - \$9.99 (\$1.00/Count)
 - Get it as soon as **Monday, Nov 20**
 - FREE Shipping on orders over \$35 shipped by Amazon
- MEILIDY 5 Hooks, Reversible Black S Shaped Hooks 3 Inch Small Heavy Duty Stainless Steel S...**
 - ★ ★ ★ ★ ★ 107
 - \$9.99
 - Get it as soon as **Sunday, Nov 19**
 - FREE Shipping on orders over \$35 shipped by Amazon
- Riveay 10 Pack Black S Hooks for Hanging Plants, 5 Hooks for Hanging Clothes, Stainless Steel S Hook...**
 - ★ ★ ★ ★ ★ 4,675
 - \$4.99 (\$0.50/Count)
 - Get it as soon as **Tuesday, Nov 21**
 - FREE Shipping on orders over \$35 shipped by Amazon
- 30 Pack 5 Hooks for Hanging, 3.15 Inch Stainless Steel S Snapped Hooks Curtain Hooks Heavy Duty 5 Hooks fo...**
 - ★ ★ ★ ★ ★ 36
 - \$12.99
 - Get it as soon as **Sunday, Nov 19**
 - FREE Shipping on orders over \$35 shipped by Amazon
- GEZIDEA Purse Hanger 5 Hooks Twisted 5 Hooks Closet Rod Hooks for Handbags,Bags,Clothes,Purses,Hats,10Pack (Large&90Deg)**
 - ★ ★ ★ ★ ★ 353
- Evob 20 Pack 3.4" S Shaped Hooks Stainless Steel Metal Hangers Hanging Hooks for Kitchen, Work Shop...**
 - ★ ★ ★ ★ ★ 18,433
 - \$6.47 (\$0.32/Count)
 - Get it as soon as **Sunday, Nov 19**
 - FREE Shipping on orders over \$35 shipped by Amazon

From the brand

Brand Description
AccEncyc is committed to provide customers preferably with satisfactory products and more intimate service.

Hello, we are AccEncyc, the combination of Accessory and Encyclopedia, which represents the core concept of our brand, presenting abundant, professional and practical products to you in an encyclopedia-like manner. Here, you can find everything devoted to make your life much more better, including hardware, tools and pet supplies. We start with providing accessories, but not just accessories.

Recommended Goods

Looking for specific info?

Videos

Videos for related products

- CTOHN Purse Hangers for Closet** - JINGWEI-US (0:46)
- 5 Closet Organizational Must Haves** - Jaime Cittadino (0:29)
- S-Hook's Closet Reign: No Mess Allowed** - Mike Lazarus (1:55)
- Large Size Closet Rod Hooks** - Fitnice Official (0:29)
- My Review Of The Hooks For Hangi** - Abraham (0:29)

Upload your video

Product information

Package Dimensions	4.5 x 3 x 3 inches
Item Weight	7 ounces
Department	womens
Manufacturer	AccEncyc
ASIN	B0BH8GVL6
Customer Reviews	4.6 ★★★★★ <small>6 ratings</small> 4.6 out of 5 stars
Best Sellers Rank	#974,323 in Home & Kitchen (See Top 100 in Home & Kitchen) #1,863 in Utility Hooks
Date First Available	October 12, 2022

Warranty & Support

Product Warranty: For warranty information about this product, please click here

Feedback

Would you like to [tell us about a lower price?](#)

Product Description

12 pack heavy duty s hooks for holding purses, handbags, kitchenware, coat and hat, ties, belts, wreathes and so on

Compare with similar items

This Item AccEncyc 12 Pcs Purse Hanger Closet Bag Hooks Handbag Organizer Heavy Duty 5 Hooks for Hanging Purse for Closet and Shower Stainless Steel (Silver)	ZEDODIER 14 Pack Purse Hooks for Closet, Backpack Hanger Bag Holder, Closet Accessories Organizer 5 Hook for Hanging Purses, Handbags, Bags, Belts, Scarves, Hats, Clothes, and Plant, Silver	Fitnice 10 Pack Purse Hanger for Closet, 5 Hooks for Hanging Twisted Purse Hooks Heavy Duty 5 Hooks Handbag Hanger Organizer Space Saving Closet Rod Hooks for Clothes, Bags, Plants, Pots (Black)	12 Pack Purse Hanger for Closet, Unique Twist Design Bag Hanger Purse Hooks, Large Size Closet Rod Hooks for Hanging Necklace Bags, Purses, Handbags, Belts, Scarves, Hats, Clothes, Pans and Pots, Black	Evob 20 Pack 5.4\"/>
Add to Cart	Add to Cart	Add to Cart	Add to Cart	Add to Cart
Customer Rating ★★★★★ (6)	★★★★★ (100)	★★★★★ (184)	★★★★★ (1307)	★★★★★ (18433)
Price \$4.59	\$7.99	\$9.99	\$9.69	\$6.47
Shipping FREE Shipping on orders over \$35.00 shipped by Amazon or get Fast, Free Shipping with Amazon Prime	FREE Shipping on orders over \$35.00 shipped by Amazon or get Fast, Free Shipping with Amazon Prime	FREE Shipping on orders over \$35.00 shipped by Amazon or get Fast, Free Shipping with Amazon Prime	FREE Shipping on orders over \$35.00 shipped by Amazon or get Fast, Free Shipping with Amazon Prime	FREE Shipping on orders over \$35.00 shipped by Amazon or get Fast, Free Shipping with Amazon Prime
Sold By AccEncyc US	ZEDODIER	Fitnice Official	LiteViso	Evob
Color Silver	Silver	Black	Black	Silver
Material Stainless Steel	Metal	Stainless Steel, Plastic	Rubber, Alloy Steel	Stainless Steel

Important information

To report an issue with this product, [click here](#).

Products related to this item

Sponsored

Page 1 of 20

Purse Hangers 16 Pack Bag Hooks, Twist Shape Purse Hooks for Closet, Large Size Clo...
★★★★★ 42
\$11.99 [prime](#)

HomeyHandcraft 8 Pack 6 Inch Rattan 5 Hooks for Hanging, Hangers 5 Shaped Hooks for...
★★★★★ 33
\$24.99 (\$3.12/Count)
[prime](#)

AMKJFO Hangers-Space-Saving-12 Pack-Closet-Organizers-and-Storage for Dorm...
★★★★★ 78
\$11.99 (\$1.00/Count)
[prime](#)

KELITOPS 12 Pack 5 Hooks for Hanging, 3.5 inch Heavy Duty 5 Hooks with Safety Buckl...
★★★★★ 49
\$5.99 (\$0.50/Count)
[prime](#)

BESARME 15 Pack Purse Hanger for Closet, Unique Twist Design Bag Hanger Hooks, Purses...
★★★★★ 314
\$9.99 (\$0.67/Count)
[prime](#)

CTOHN 20 Pack Purse Hanger for Closet, Unique Twist Design Bag Hanger Purse Hooks, ...
★★★★★ 17
\$9.98 (\$0.50/Count)
[prime](#)

BCISIWOS Purse Hanger for Closet, 10 Pack Handbag Hanger Organizer Unique...
★★★★★ 30
\$6.99 [prime](#)



Amazon Brand - Wag Grain Free Dry Dog Food for...

★★★★★ 2,702

16% off Deal

\$27.92 ~~\$33.14~~ [prime](#)

[Add to cart](#)

Sponsored

Similar brands on Amazon

Sponsored

Page 1 of 2

TECI Shop the Store on Amazon

TECI Solid Brass Coat Hooks Heavy Duty Wall Mounted.Perfect for Purse,Coats,...
★★★★★ 112
\$25.99

TICONN Shop the Store on Amazon

TICONN Wall Mounted Coat Rack, Five Heavy Duty Tri Hooks All Metal...
★★★★★ 1,444
\$18.46

HOME DEPUTY Shop the Store on Amazon

HOME DEPUTY 6 Pack Purse Organizers for Closet - 6 Bag Hooks - Silver - Purse...
★★★★★ 511
\$12.50 typical: \$44.60

Customer reviews

★★★★★ 4.6 out of 5

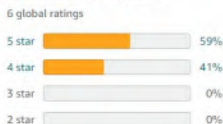

Reviews with images



[See all photos](#)

1 star 0%

How customer reviews and ratings work

Review this product

Share your thoughts with other customers

Write a customer review

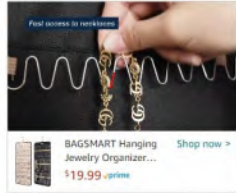

BAGSMART Hanging Jewelry Organizer... \$19.99

Top reviews from the United States

Knighman
 ★★★★★ **Closet Hooks**
 Reviewed in the United States on August 16, 2023
 Color: Black **Vine Customer Review of Free Product** (What's this?)
 I got these to hang bags, scarves, and accessories and they work well for this. It's easy to hang it over the bar just like a hanger, then hang the item on the end. There's really not much to it, lol.

Helpful Report

Bree VINE VOICE
 ★★★★★ **Super handy!**
 Reviewed in the United States on July 11, 2023
 Color: Black **Vine Customer Review of Free Product** (What's this?)
 These are so useful. I like that they have rubber-coated tips so your stuff doesn't snag. They have an impressive weight capacity. I hung both my delicate scarves and hefty totes on them and it holds them up like a champ so I can sort my things in my closet and find them quickly.

I love that they stack to take up very little space when not in use (see first photo).

Great closet organizational tool!



Helpful Report

See more reviews

4 stars and above

Page 1 of 27

- Seamaka 12 pcs 3.5 inch Silver 5 Hooks, Heavy Duty S Shaped Hook with Hanging Rust-P...**
 ★★★★★ 477
 \$8.99
- Vantasi 10 Pack 5 Hooks for Hanging, Rustproof S-Shaped Hook with Safety Buckle He...**
 ★★★★★ 121
 \$7.50
- Purse Hanger Organizer for Closet 2-Pack, Fitnice Metal Handbag Hangers Space Savin...**
 ★★★★★ 57
 \$9.99
- LOYMR 16 Pack 4.7 Inches Extra Large S Shape Hooks Heavy-Duty Metal Hanging...**
 ★★★★★ 453
 \$15.99
- BESARME 15 Pack Purse Hanger for Closet, Unique Twist Design Bag Hanger Hooks, Purses...**
 ★★★★★ 314
 \$9.99
- Fitnice 10 Pack Purse Hanger for Closet, 5 Hooks for Hanging Twisted Purse Hooks...**
 ★★★★★ 184
 \$9.99
- ZEDODIER 14 Pack Purse Hooks for Closet, Backpack Hanger Bag Holder, Closet Accesso...**
 ★★★★★ 100
 \$7.99

Amazon Brand - Wag Dry Dog Food Chicken & Sweet Potato, ...
 ★★★★★ 19,672
 75% off Deal
 Shop now

Best Sellers in this category

Page 1 of 6

- ACTIVE WASHING MACHINE CLEANER**
 Deep Cleaning Tablets For HE Front Loader & Top Load Washer, Sept...
 ★★★★★ 98,474
 \$16.95
- BISSELL Little Green Multi-Purpose Portable Carpet and Upholstery...**
 #1 Best Seller in Carpet & Upholstery Cleaning Machines
 78% off Deal
 \$189.00
- O-Cedar EasyWring MicroFiber Spin Mop, Bucket Floor Cleaning System, Red, Gray**
 #1 Best Seller in Household Mops & Bucket Sets
 \$134.97
- Beckham Hotel Collection Bed Pillows Standard / Queen Size Set of 2 - Down...**
 #1 Best Seller in Bed Pillows
 \$60.99
- Utopia Bedding Throw Pillows (Set of 4, White), 18 x 18 Inches Pillows for Sofa, Bed and Couch...**
 #1 Best Seller in Throw Pillows
 \$22.99
- GiveBest Portable Electric Space Heater with Thermostat, 1500W/750W Safe and Quiet Ceramic Heater...**
 #1 Best Seller in Electric Space Heaters
 \$29.99
- Pure Enrichment MistAire Ultrasonic Cool Mist Humidifier - Premium Humidifying...**
 #1 Best Seller in Ultrasonic Humidifiers
 \$39.99
- BigFoot Shower Curtain Liner - 72 x 72 PEVA Heavy Duty Shower Curtain with Rustproof Metal Grommet and S...**
 #1 Best Seller in Shower Curtains
 \$18.79
- Space Heater, 1500W Electric Heaters Indoor Portable with Thermostat, PTC Fast Heating Ceramic Room...**
 #1 Best Seller in Electric Heaters
 \$29.99

Customers who viewed items in your browsing history also viewed

Page 1 of 6

- 12 Pack Purse Hanger for Closet, Unique Twist Design Bag Hanger Purse Hooks, Large Size Clos...**
 ★★★★★ 1,307
 Amazon's Choice in Tie Racks
- Fitnice 10 Pack Purse Hanger for Closet, 5 Hooks for Hanging Twisted Purse Hooks Heavy Duty S Hooks...**
 ★★★★★ 184
 \$9.99
- Purse Hanger Organizer for Closet, 5 Hooks Twist Design Bag Hanger, Closet Rod Hooks for Hanging...**
 ★★★★★ 439
 \$8.98
- ZEDODIER 14 Pack Purse Hooks for Closet, Backpack Hanger Bag Holder, Closet Accessories Organizer ...**
 ★★★★★ 100
 \$7.99
- BESARME 15 Pack Purse Hanger for Closet, Unique Twist Design Bag Hanger Hooks, Purse...**
 Amazon's Choice in Utility Hooks
 \$9.99
- Myfolrexa Purse Hangers Bag Hooks Closet- 12 Pack Handbag Hanger Organizer Metal S Hooks, Large Size Clos...**
 ★★★★★ 229
 \$9.99
- CTOHN 20 Pack Purse Hanger for Closet, Unique Twist Design Bag Hanger Purse Hooks, Purse Organizer Hooks...**
 ★★★★★ 17
 \$9.98
- GEZIDEA Purse Hanger S Hooks Twisted 5 Hooks Closet Rod Hooks for Handbags, Bags, Clothes, Purses, Hats, 10Pack (Large&90Deg)**
 ★★★★★ 353
- MEILIDY 5 Hooks, Reversible Black S Shaped Hooks 3 Inch Small Heavy Duty Stainless Steel S...**
 ★★★★★ 107
 \$9.99

19.69 (\$0.81/Count)
Get it as soon as **Sunday, Nov 19**
FREE Shipping on orders over \$35 shipped by Amazon

Get it as soon as **Monday, Nov 20**
FREE Shipping on orders over \$35 shipped by Amazon

Get it as soon as **Sunday, Nov 19**
FREE Shipping on orders over \$35 shipped by Amazon

Get it as soon as **Sunday, Nov 19**
FREE Shipping on orders over \$35 shipped by Amazon

19.99 (\$0.67/Count)
Get it as soon as **Sunday, Nov 19**
FREE Shipping on orders over \$35 shipped by Amazon

Get it as soon as **Sunday, Nov 19**
FREE Shipping on orders over \$35 shipped by Amazon

Get it as soon as **Sunday, Nov 19**
FREE Shipping on orders over \$35 shipped by Amazon

Get it as soon as **Sunday, Nov 19**
FREE Shipping on orders over \$35 shipped by Amazon

See personalized recommendations

Sign in

New customer? Start here.

Back to top

Get to Know Us

- Careers
- Amazon Newsletter
- About Amazon
- Accessibility
- Sustainability
- Press Center
- Investor Relations
- Amazon Devices
- Amazon Science

Make Money with Us

- Sell on Amazon
- Sell apps on Amazon
- Supply to Amazon
- Protect & Build Your Brand
- Become an Affiliate
- Become a Delivery Driver
- Start a Package Delivery Business
- Advertise Your Products
- Self-Publish with Us
- Host an Amazon Hub
- See More Ways to Make Money

Amazon Payment Products

- Amazon Visa
- Amazon Store Card
- Amazon Secured Card
- Amazon Business Card
- Shop with Points
- Credit Card Marketplace
- Reload Your Balance
- Gift Cards
- Amazon Currency Converter

Let Us Help You

- Your Account
- Your Orders
- Shipping Rates & Policies
- Amazon Prime
- Returns & Replacements
- Manage Your Content and Devices
- Your Recalls and Product Safety Alerts
- Help



English

United States

Amazon Music
Stream millions of songs

Amp
Host your own live radio show with music you love

Goodreads
Book reviews & recommendations

Amazon Warehouse
Great Deals on Quality Used Products

Amazon Ads
Reach customers wherever they spend their time

Amazon Fresh
Groceries & More Right To Your Door

IMDb
Movies, TV & Celebrities

Whole Foods Market
America's Healthiest Grocery Store

Neighbors App
Real-Time Crime & Safety Alerts

Epm
Score deals on fashion brands

AmazonGlobal
Ship Orders Internationally

IMDbPro
Get Info Entertainment Professionals Need

Woot!
Deals and Shenanigans

Amazon Subscription Boxes
Top subscription boxes - right to your door

AbelBooks
Books, art & collectibles

Home Services
Experienced Pros. Happiness Guarantee.

Kindle Direct Publishing
Indie Digital & Print Publishing Made Easy

Zappos
Shoes & Clothing

PillPack
Pharmacy Simplified

ACX
Audiobook Publishing Made Easy

Amazon Web Services
Scalable Cloud Computing Services

Amazon Photos
Unlimited Photo Storage Free With Prime

Ring
Smart Home Security Systems

Amazon Renewed
Like-new products you can trust

Sell on Amazon
Start a Selling Account

Audible
Listen to Books & Original Audio Performances

Prime Video Direct
Video Distribution Made Easy

eero WiFi
Stream 4K Video in Every Room

Amazon Business
Everything For Your Business

Box Office Mojo
Find Movie Box Office Data

Shopbop
Designer Fashion Brands

Blink
Smart Security For Every Home

Second Webpage Showing Sale of Infringing
Product Type 3

Home & Kitchen > Storage & Organization > Home Storage Hooks > Utility Hooks

10 Pack Large Size Purse Hanger

Fits Max 1.6 inch Diameter Round or Flat Closet Rod



PUPINGPIG Purse Hangers for Closet Organizer, Set of 10 Purse Hook for Closet Unique Twist Design Bag Hanger Large Size Closet Hooks for Bag, Purses, Handbags, Belts, Pots and Pans (Black)

Visit the PUPINGPIG Store 4.8 ★★★★★ 164 ratings

-9% \$9.99 Typical price: \$10.99

Get Fast, Free Shipping with Amazon Prime

FREE Returns

Get a \$60 gift card instantly: Pay \$0.00 \$9.99 upon approval for the Amazon Store Card. Find out how

Color: Black

Color: Black \$9.99

Material: Stainless Steel

Brand: PUPINGPIG

Mounting Type: Desk Mount

Maximum Weight Recommendation: 10 Kilograms

About this item

- Sturdy Purse Hanger: Vinyl coated purse hooks made of high quality stainless steel, hard and sturdy. Outer layer coated with soft rubber to keep your handbag straps protected. Perfect for hanging bags front to back, a great way to keep your purses in great shape
- Improved Design Purse Hanger Hooks: We improved the classical regular S hook and twisted it 90° so that you can display your handbags and purses side by side at eye level. Save more spaces to store more purses/Backpacks in your closet, also you will choose bags more convenient
- Large Size Purse Hooks for Closet: Each package including 10pcs large size BLACK purse hanger hooks. H: 4.3 inches, W: 2.2 inches, big enough to fit most closet rods less than 1.8inches. Each wallet hanger can hold items up to 10kg
- Widely Applications: This large size hook can be widely used, available to organizer for closet to store purse, wallet, small to medium handbags. Also can be used for displaying plants/wind chimes, bird feeders, bird house or tidy other tools indoor/outdoor. Providing you perfect space-saving storage solution
- Easy to Use: Not require to use tools,nails, screws, or adhesives, these handbag hooks are easy to hang on existing objects. Please notice this is kind of large Utility Hooks, if it easy to off, please use a rope to fasten the hook on closet rod

Customer ratings by feature

Sturdiness	★★★★★ 5.0
Easy to use	★★★★★ 4.8
Value for money	★★★★★ 4.7

See all reviews



prime Enjoy fast, FREE delivery, exclusive deals and award-winning movies & TV shows with Prime Try Prime and start saving today with Fast, FREE Delivery

\$9.99 Get Fast, Free Shipping with Amazon Prime FREE Returns FREE delivery Monday, November 27 on orders shipped by Amazon over \$35

In Stock Qty: 1 Add to Cart Buy Now

Ships from Amazon Sold by Autrow Returns Returnable until Jan 31, 2024 Payment Secure transaction Add a gift receipt for easy returns Add to List



Infringing Product Type 3

Frequently bought together

Total price: \$31.96 Add all 3 to Cart

These items are shipped from and sold by different sellers. Show details

Products related to this item

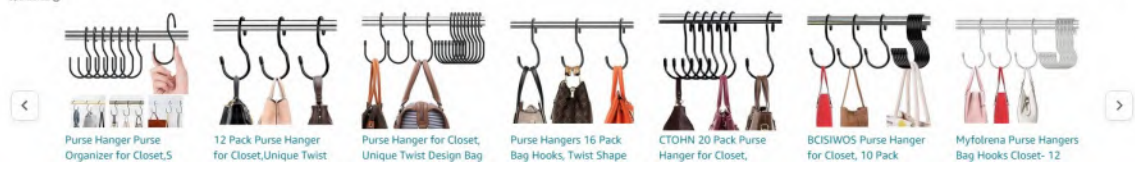

- Hooks Twist Design Bag Hanger,Closet Rod ...
★★★★★ 439
\$8.98 (\$1.12/Count)
✓prime
- Design, Large Size Closet Rod Hooks fo...
\$9.39 (\$0.78/Count)
✓prime
- Hanger Purse Hooks, Large Size Clo...
★★★★★ 37
\$9.99 (\$0.83/Count)
✓prime
- Purse Hooks for Closet, Large Size Clo...
★★★★★ 42
\$11.99 ✓prime
- Unique Twist Design Bag Hanger Purse Hooks, ...
★★★★★ 17
\$9.98 (\$0.50/Count)
✓prime
- Handbag Hanger Organizer Unique...
★★★★★ 30
\$6.99 ✓prime
- Pack Handbag Hanger Organizer Metal S ...
★★★★★ 227
\$9.99 ✓prime

4 stars and above

Sponsored @

- BESARME 15 Pack Purse Hanger for Closet, Unique Twist Design Bag Hanger Hooks, Purses...
★★★★★ 314
\$9.99 (\$0.67/Count)
✓prime
- ZEDODIER 14 Pack Purse Hooks for Closet, Backpack Hanger Bag Holder, Closet Access...
★★★★★ 100
\$7.99 (\$0.57/Count)
✓prime
- Purse Hanger Organizer for Closet 2-Pack, Fitnice Metal Handbag Hangers Space Savin...
★★★★★ 57
\$9.99 (\$5.00/Count)
✓prime Save 10% with coupon
- Mzekgm 10 Pack Purse Hanger for Closet, Unique Twist Design Closet Organizer...
★★★★★ 153
\$11.99 (\$1.20/Count)
✓prime
- Purse Hanger Purse Organizer for Closet,5 Hooks Twist Design Bag Hanger,Closet Rod ...
★★★★★ 439
\$8.98 (\$1.12/Count)
✓prime
- Myfolrena Purse Hangers Bag Hooks Closet- 12 Pack Handbag Hanger Organizer Metal S ...
★★★★★ 227
\$9.99 ✓prime
- 12 Pack Purse Hanger for Closet,Unique Twist Design Bag Hanger Purse Hooks, Large S...
★★★★★ 1,280
\$9.99 (\$0.83/Count)
✓prime

From the brand

PUPINGPIG

As a store without very long history, our primary goal is showing good products on Amazon and gain more and more fans

Meet Your Demand: Professional for HOUSE & HOME TOOL products, we will keep tracking trending and provide you more quality items

Just Enjoy buy and Have fun!

What Stuff We Have?
 Here we have various of home&house tool stuff for your reference, such as plant hook for outdoor, purse hanger hook, etc

How is the quality?
 We quality check each piece of items and pack them with suitable way, to ensure the thing work to you work well

What You Will Get?
 We have high quality items, also we provide good service. If you have any question or confusion, let us know, will solve your issue within 24hours

ITEMS FOR HOUSE
 Visit the Store

Product Description



10 Pack Purse Hanger for Closet, Unique Twist Design Bags Hanger Hooks Large Size Twisted Purse Hooks

- Vinyl Coated Protect: Each purse hanger hook has two rubber stopper on the end, which can Anti-rust, resist falling and slipping
- Improved design S hook: Our S hooks handbag hanger with an upgraded version of the S hook, twisting it 90° makes this wallet hanger more stable vertically on your closet rod, so you can display your handbags and purses side by side at eye level
- Multiple Uses: purse hanger hooks can be used to hang wallets, as well as belts, handbags, ties, jeans, scarves, towels, plants, pots and pans, cups, wind chimes, bird feeders, bird houses, indoor and outdoor use



Large Size Closet Rod Hooks
Each s-shaped hook opening size is 1.7 inch, another opening size is 1.8inch, it fit for all regular closet rods less than 1.8inch thickness
Easy to Use
No tools, nails, screws or adhesives are required, this large size utility hooks are easy to hang on existing objects, can hold lots of item to help you save more space in your home

Large Quantity for home USE
• Color: Silver, Black
• Package: 10pcs for each set
Heavy Duty Purse Hanger Hooks
These purse organizer bag hangers are made of high-quality stainless steel, hard and sturdy enough. Keep your beloved bags away from floor and dust!
These large size handbag hooks for closet have large and small heads, not heavy but very sturdy to hold items up to 10kgs



Perfect for Closet storage and organization, Make your life more organized!



Unique Twist Design S Hooks
It is twisted from regular s hooks, allows you hang your bags vertically in the closet, save more spaces and choose bags more convenient
You can hang your handbags side by side alongside your clothes providing the perfect space-saving storage solution

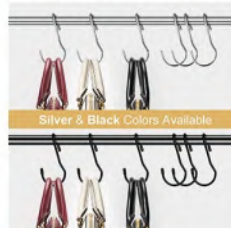

Silver&Black Color Available
These durable metal handbag hook can be perfect solution for hanging your handbag purse in your closet
Just the simple way these hooks are oriented makes organizing handbags in the closet so much easier and nicer



Warm Tip Before Order
If the purse hanger hook is easy to off, please use a rope to fasten the hook on closet rod
This closet organizer hooks fits all closet rods less than 1.8inches. PLEASE MEASURE YOUR CLOSET ROD, and check if item size suitable before purchase



This hook is hard enough for hanging pots, pans, cups and other kitchen utensil; also suit for wind chimes, bird feeders, plants indoor and outdoor



Looking for specific info?

Product information

Package Dimensions	9.06 x 8.39 x 3.11 inches
Item Weight	10.1 ounces
Manufacturer	PUPINGPIG
ASIN	B09TZRQNH8
Country of Origin	China
Customer Reviews	4.8 164 ratings 4.8 out of 5 stars
Best Sellers Rank	#75,930 in Industrial & Scientific (See Top 100 in Industrial & Scientific) #1,170 in Utility Hooks #1,647 in Industrial Hooks #39,527 in Hardware
Maximum recommended load	10 Kilograms
Finish types	Matte
Number of pieces	10
Batteries required	No

Warranty & Support

Product Warranty: For warranty information about this product, please click here

Feedback

Would you like to [tell us about a lower price?](#)

Videos

Page 1 of 3

Videos for related products

<

15 Pack Purse Hanger for Closet, for Better Organized
zhangheting 0:30

Are these purse hooks gonna keep your purse looking nice?
Colleen Cupp 0:45

Large Size Closet Rod Hooks
Fitnice Official 0:28

CTOHN Purse Hangers for Closet
JINGWEI-US 0:46

S-Hook's Closet Allowed
Miko Lazarus

>

[Upload your video](#)

Important information

To report an issue with this product, [click here](#).

Compare with similar items

	This item PUPINGPIG Purse Hangers for Closet Organizer, Set of 10 Purse Hook for Closet Unique Twist Design Bag Hanger Large Size Closet Hooks for Bag, Purses, Handbags, Belts, Pots and Pans (Black)	BESARME 15 Pack Purse Hanger for Closet, Unique Twist Design Bag Hanger Hooks, Purse Organizer Hooks for Closet Large Closet S Hooks for Hanging Handbags Purses Clothes(Black)	Myfolrenea Purse Hangers Bag Hooks Closet- 12 Pack Handbag Hanger Organizer Metal 5 Hooks, Large Size Closet Rod Hooks for Hanging Handbags,Clothes, Curtain, Plant, Pans and Pots	Purse Hanger Purse Organizer for Closet,5 Hooks Twist Design Bag Hanger,Closet Rod Hooks for Hanging Handbags,Purses,Belts,Scarves,Hats,Clothes,Pots and Pans. (8 Pack Black)	Fitnice 10 Pack Purse Hanger for Closet, 5 Hooks for Hanging Twisted Purse Hooks Heavy Duty S Hooks Handbag Hanger Organizer Space Saving Closet Rod Hooks for Clothes, Bags, Plants, Pots (Black)
	Add to Cart	Add to Cart	Add to Cart	Add to Cart	Add to Cart
Customer Rating	(164)	(314)	(229)	(439)	(184)
Price	\$9 ⁹⁹	\$9 ⁹⁹	\$9 ⁹⁹	\$8 ⁹⁸	\$9 ⁹⁹
Shipping	FREE Shipping on orders over \$35.00 shipped by Amazon or get Fast, Free Shipping with Amazon Prime	FREE Shipping on orders over \$35.00 shipped by Amazon or get Fast, Free Shipping with Amazon Prime	FREE Shipping on orders over \$35.00 shipped by Amazon or get Fast, Free Shipping with Amazon Prime	FREE Shipping on orders over \$35.00 shipped by Amazon or get Fast, Free Shipping with Amazon Prime	FREE Shipping on orders over \$35.00 shipped by Amazon or get Fast, Free Shipping with Amazon Prime
Sold By	Autrow	zhangheting	Myfolrenea Official	NEZA-US	Fitnice Official
Color	Black	Black	Silver	Black	Black
Material	Stainless Steel	Vinyl	Stainless Steel, Metal	Metal, Vinyl	Stainless Steel, Plastic

Products related to this item

Page 1 of 20

Sponsored

Similar brands on Amazon

Page 1 of 2

Sponsored

Customer reviews

4.8 out of 5

164 global ratings

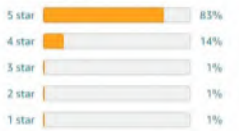

How customer reviews and ratings work

By feature

Sturdiness	★★★★★ 5.0
Easy to use	★★★★★ 4.8
Value for money	★★★★★ 4.7

Review this product

Share your thoughts with other customers

Write a customer review

Reviews with images

See all photos

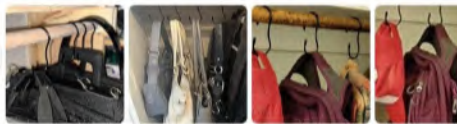

Top reviews

Top reviews from the United States

Translate all reviews to English

Patricia Fernández
★★★★★ **Bien**
Reviewed in the United States on May 6, 2023
Color: Silver **Verified Purchase**
Después que las tengo, no me resultan tan útil

Helpful Report

Translate review to English

PS
★★★★★ **Convenient and compact**
Reviewed in the United States on March 2, 2023
Color: Black **Verified Purchase**
The hooks are strong and an efficient use of space.

Helpful Report

ZimFromirk
★★★★★ **These do the job they're supposed to do**
Reviewed in the United States on September 23, 2022
Color: Black **Verified Purchase**
Good solid hangers. I use them for the plethora -- PLETHORA! -- of laptop and camera bags I've accumulated over the years and won't part with. These hangers allow me to... hang them in my office closet instead of taking up excessive shelf space or keeping them in a pile on the floor.

If they can handle laptop bags, camera bags, and backpacks, they'll probably hang purses and other things with handles just fine.



2 people found this helpful

Helpful Report



Organization Use

Reviewed in the United States on February 1, 2023

Color: Black **Verified Purchase**

Great for organizing closet space

Helpful Report



Perfect

Reviewed in the United States on December 1, 2022

Color: Black **Verified Purchase**

These were exactly what I needed. They are very sturdy and the color blended perfectly with my closet design. I will be purchasing more.

Helpful Report



So organized now

Reviewed in the United States on November 25, 2022

Color: Black **Verified Purchase**

These really came in handy. Should have bought them along time ago. I can actually see what I have now.

Helpful Report

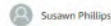

Organization

Reviewed in the United States on October 10, 2022

Color: Silver **Verified Purchase**

I use the hooks to keep my favorite bags, and purses organized. The hooks make my bags easy to see, while keeping them within reach.

Helpful Report



LOVE

Reviewed in the United States on September 24, 2022

Color: Black **Verified Purchase**

Exactly what I was looking for and work great for my closet setup!

Helpful Report

[See more reviews](#)

Similar items that may ship from close to you

					
<p>BESARME 15 Pack Purse Hanger for Closet, Unique Twist Design Bag Hanger Purse Organizer Hooks for... ★★★★★ 314 \$9.99 (\$0.67/Count) Get it as soon as Sunday, Nov 19 FREE Shipping on orders over \$35 shipped by Amazon</p>	<p>12 Pack Purse Hanger for Closet, Unique Twist Design Bag Hanger Purse Hooks, Large Size Clos... ★★★★★ 1,307 Amazon's Choice In Tie Racks \$9.69 (\$0.81/Count) Get it as soon as Sunday, Nov 19 FREE Shipping on orders over \$35 shipped by Amazon</p>	<p>Myfolreia Purse Hangers Bag Hooks Closet- 12 Pack Handbag Hanger Organizer Metal S Hooks, Large Size Clos... ★★★★★ 229 \$9.99 Get it as soon as Sunday, Nov 19 FREE Shipping on orders over \$35 shipped by Amazon</p>	<p>Purse Hanger Purse Organizer for Closet, S Hooks Twist Design Bag Hanger, Closet Rod Hanger, Closet Rod Hooks for Hanging... ★★★★★ 459 \$8.98 (\$1.12/Count) Get it as soon as Sunday, Nov 19 FREE Shipping on orders over \$35 shipped by Amazon</p>	<p>BCISIWOS Purse Hanger for Closet, 10 Pack Handbag Hanger... ★★★★★ 30 Save 6% \$6.99 Typical: \$7.59 Lowest price in 30 days Get it as soon as Sunday, Nov 19 FREE Shipping on orders over \$35 shipped by Amazon</p>	<p>Evob 20 Pack 3.4\" ★★★★★ 16,433 Amazon's Choice In Utility Hooks \$6.47 (\$0.32/Count) Get it as soon as Sunday, Nov 19 FREE Shipping on orders over \$35 shipped by Amazon</p>

Amazon Brand - Wag Dry Dog Food Salmon & Sweet Potato, ...
 ★★★★★ 19,672
 32% off Deal [Shop now](#)
 Sponsored

Best Sellers in Industrial & Scientific

- MedPride Powder-Free Nitrile Exam Gloves, Medium, Box/100**
 ★★★★★ 86,073
#1 Best Seller in Industrial & Scientific
 \$9.99 (\$0.10/Count)
 Get it as soon as **Sunday, Nov 19**
 FREE Shipping on orders over \$35 shipped by Amazon
- iHealth COVID-19 Antigen Rapid Test, 1 Pack, 5 Tests Total, FDA EUA Authorized OTC...**
 ★★★★★ 19,056
#1 Best Seller in Clinical Diagnostic Test Kits
 \$44.95 (\$8.99/Count)
 Get it as soon as **Sunday, Nov 19**
 FREE Shipping by Amazon
- Cascade Platinum Plus ActionPacs Dishwasher Detergent Pods, Fresh, 62 Count**
 ★★★★★ 87,487
#1 Best Seller in Commercial Dishwasher Detergents
 \$17.59 (\$0.28/Count)
 Get it as soon as **Wednesday, Nov 22**
 FREE Shipping on orders over \$35 shipped by Amazon
- Pampers Sensitive Baby Wipes - Baby Wipes Combo, 1008 Count, Water Based,...**
 ★★★★★ 198,946
#1 Best Seller in Electronic Component Sensors
 \$34.97 (\$3.47/100 Count)
 Get it as soon as **Monday, Nov 20**
 FREE Shipping on orders over \$35 shipped by Amazon
- Med PRIDE NitrilPride Nitrile-Vinyl Blend Exam Gloves, Medium 100 - Powder Free, Latex Fre...**
 ★★★★★ 40,932
Amazon's Choice in Medical Exam Gloves
 \$9.99 (\$0.10/Count)
 Get it as soon as **Sunday, Nov 19**
 FREE Shipping on orders over \$35 shipped by Amazon
- SYLVANIA ECO LED Light Bulb, A19 60W Equivalent, Efficient 9W, 7 Year, 750 Lumens,...**
 ★★★★★ 41,995
#1 Best Seller in LED Bulbs
 \$13.42 (\$1.68/Count)
 Get it as soon as **Tuesday, Nov 21**
 FREE Shipping on orders over \$35 shipped by Amazon

Customers who viewed items in your browsing history also viewed

- 
- 12 Pack Purse Hanger for Closet, Unique Twist Design Bag Hanger Purse Hooks, Large Size Clos...**
 ★★★★★ 1,307
Amazon's Choice in Tie Racks
 \$9.69 (\$0.81/Count)
 Get it as soon as **Sunday, Nov 19**
 FREE Shipping on orders over \$35 shipped by Amazon
 - Purse Hanger Purse Organizer for Closet, 5 Hooks Twist Design Bag Hanger, Closet Rod Hooks for Hanging...**
 ★★★★★ 439
 \$8.98 (\$1.12/Count)
 Get it as soon as **Sunday, Nov 19**
 FREE Shipping on orders over \$35 shipped by Amazon
 - Fitnice 10 Pack Purse Hanger for Closet, 5 Hooks for Hanging Twisted Purse Hooks Heavy Duty 5 Hooks...**
 ★★★★★ 184
 \$9.99 (\$1.00/Count)
 Get it as soon as **Monday, Nov 20**
 FREE Shipping on orders over \$35 shipped by Amazon
 - ZEDODIER 14 Pack Purse Hooks for Closet, Backpack Hanger Bag Holder, Closet Accessories Organizer ...**
 ★★★★★ 100
 \$7.99 (\$0.57/Count)
 Get it as soon as **Sunday, Nov 19**
 FREE Shipping on orders over \$35 shipped by Amazon
 - BESARME 15 Pack Purse Hanger for Closet, Unique Twist Design Bag Hanger Hooks, Purse...**
 ★★★★★ 314
Amazon's Choice in Utility Hooks
 \$9.99 (\$0.67/Count)
 Get it as soon as **Sunday, Nov 19**
 FREE Shipping on orders over \$35 shipped by Amazon
 - Myfolrenea Purse Hangers Bag Hooks Closet- 12 Pack Handbag Hanger Organizer Metal 5 Hooks, Large Size Clos...**
 ★★★★★ 229
 \$9.99
 Get it as soon as **Sunday, Nov 19**
 FREE Shipping on orders over \$35 shipped by Amazon

See personalized recommendations
[Sign in](#)
 New customer? Start here.

Back to top

Get to Know Us

- Careers
- Amazon Newsletter
- About Amazon
- Accessibility
- Sustainability
- Press Center
- Investor Relations
- Amazon Devices
- Amazon Science

Make Money with Us

- Sell on Amazon
- Sell apps on Amazon
- Supply to Amazon
- Protect & Build Your Brand
- Become an Affiliate
- Become a Delivery Driver
- Start a Package Delivery Business
- Advertise Your Products
- Self-Publish with Us
- Host an Amazon Hub
- > See More Ways to Make Money

Amazon Payment Products

- Amazon Visa
- Amazon Store Card
- Amazon Secured Card
- Amazon Business Card
- Shop with Points
- Credit Card Marketplace
- Reload Your Balance
- Gift Cards
- Amazon Currency Converter

Let Us Help You

- Your Account
- Your Orders
- Shipping Rates & Policies
- Amazon Prime
- Returns & Replacements
- Manage Your Content and Devices
- Your Recalls and Product Safety Alerts
- Help



English United States

- Amazon Music**
Stream millions of songs
- Amazon Ads**
Reach customers wherever they spend their time
- Spn**
Score deals on fashion brands
- AbeBooks**
Books, art & collectibles
- ACX**
Audiobook Publishing Made Easy
- Sell on Amazon**
Start a Selling Account
- Amazon Business**
Everything For Your Business
- Amp**
Host your own live radio show with music you love
- Amazon Fresh**
Groceries & More Right To Your Door
- Amazon Global**
Ship Orders Internationally
- Home Services**
Experienced Pros Happiness Guarantee
- Amazon Web Services**
Scalable Cloud Computing Services
- Audible**
Listen to Books & Original Audio Performances
- Box Office Mojo**
Find Movie Box Office Data
- Goodreads**
Book reviews & recommendations
- IMDb**
Movies, TV & Celebrities
- IMDbPro**
Get Info Entertainment Professionals Need
- Kindle Direct Publishing**
Indie Digital & Print Publishing Made Easy
- Amazon Photos**
Unlimited Photo Storage Free With Prime
- Prime Video Direct**
Video Distribution Made Easy
- Shopbop**
Designer Fashion Brands
- Amazon Warehouse**
Great Deals on Quality Used Products
- Whole Foods Market**
America's Healthiest Grocery Store
- Woot!**
Deals and Shenanigans
- Zappos**
Shoes & Clothing
- Ring**
Smart Home Security Systems
- eero WiFi**
Stream 4K Video in Every Room
- Blink**
Smart Security for Every Home

Neighbors
App
Real-Time
Crime
& Safety
Alerts

Amazon Subscription
Boxes
Top subscription boxes
— right to your door

PHIPack
Pharmacy
Simplified

Amazon
Renewed
Like new
products
you can trust

[Conditions of Use](#) [Privacy Notice](#) [Your Ads Privacy Choices](#)  

© 1996-2023, Amazon.com, Inc. or its affiliates

Third Webpage Showing Sale of Infringing
Product Type 3

Evob

Stylish, Efficient Storage Solution

\$7.47



Consider these available items

BCISIWOS Purse Hanger for Closet, 10 Pack Handbag Hanger Organizer Unique Twist Design Bag Hanger Purse Hooks, Large Size Closet Rod Hooks for Hanging Purses, Handbags, Clothes, Pl...

★★★★★ 30

\$6.99

BCISIWOS Purse Hanger for Closet, 12 Pack Purse Hooks Organizer Unique Twist Design Bag Hanger Purse Hooks, 4.5 Inch Large Size Bag Hanger Hooks for Hanging Bags, Purses, Clothes, Pans &...

★★★★★ 30

\$7.99

10 Pack Purse Hanger for Closet, 5 Hooks Twist Design Bag Hanger, Large Size Closet Rod Hooks for Hanging Purses, Belts, Handbags, Scarves, Hats, Clothes, Pans and Pots (Silver)

★★★★★ 64

\$9.99 (\$2.00/ounce)

Home & Kitchen > Storage & Organization > Home Storage Hooks > Utility Hooks

12 PACK LARGE SIZE PURSE HANGER

Fits Max 1.6 inch Diameter Round or Flat Closet Rod



12 Pack Purse Hanger for Closet, DSVENROLY Unique Twist Design Closet Organizer Hanger Hooks, Closet Hooks for Hanging Purses Handbags Clothes Pans and Pots (Silver)

Visit the DSVENROLY Store

4.7 ★★★★★ 4 ratings

Best price

Currently unavailable.

We don't know when or if this item will be back in stock.

Color	Silver
Brand	DSVENROLY
Material	Alloy Steel, Plastic, Rubber
Special Feature	Anti Rust
Number of Pieces	12

About this item

- **[Excellent Quality]** : DSVENROLY closet bar hooks made of premium steel material.No snapping or bending but also have a plastic coating on the outside, so they don't rust or scratch your walls or your belongings
- **[Unique Twist Design]** Upgraded the regular 5 hook and twisted it 90°, which allows you to hang your bags vertically in the closet.All handbag hanger coated with a rubber tip on the ends to protect your handbag straps
- **[Sturdy and Useful]** Purse organizer for closet, one large opening end is 1.8 inch, the other is 1.7inch.It fits all rods less than 1.7 inch thickness. Each wallet hanger weight 0.06lbs, light and portable, but strong enough to Hold up to 22lbs.
- **[Great Space Saver]** Works perfectly for hanging bags,backpacks,jeans, belts or whatever else you may desire.With these hooks, everything hangs while turned to take up less space, which means you can easily fit in way more things in the same space
- **[Widely Applications]** The item comes with 12PC Purse Hanger Hooks. They also can be used for tidy your various accessories or tools for indoor and outdoor use, display plants/wind chimes or tidy other tools.If you wanted to, you could even hang the hooks under each other and save on vertical space as well as horizontal space

Currently unavailable.
We don't know when or if this item will be back in stock.
Delivering to Albany 12201 - Update location

Add to List

★★★★★ 379

\$8.69

Sponsored

★★★★★ 20

\$12.99

Sponsored

Products related to this item

Sponsored

Page 1 of 17

★★★★★ 17

\$9.98 (\$0.50/Count)

\$9.59 (\$0.78/Count)

★★★★★ 37

\$9.99 (\$0.83/Count)

★★★★★ 30

\$6.99

★★★★★ 29

\$12.99 (\$2.60/Count)

★★★★★ 57

\$9.99 (\$5.00/Count)

Save 10% with coupon

★★★★★ 78

\$11.99 (\$1.00/Count)

More from frequently bought brands

Sponsored

★★★★★ 227

\$9.99

★★★★★ 315

\$6.99 (\$0.58/Ft Oz)

★★★★★ 162

\$17.99 (\$2.25/Count)

★★★★★ 13

\$29.99 (\$1.67/Count)

★★★★★ 597

\$11.99 (\$3.00/Count)

★★★★★ 99

\$11.99 (\$4.00/Count)

Product Description



The twisted design of the hook helps to save space in your closet and maximizes your storage capacity



With these hooks, everything hangs while turned to take up less space, which means you can easily fit in way more things in the same space



Clever way to store your purses. Makes more room in your closet and makes it easier to see your purses and ease in selecting which bag to use



These are so versatile they could work anywhere. Excellent way to remove clutter and keep purses looking great.



Sturdy and Durable Purse Hooks
one large opening end is 1.8 inch,
the other is 1.7inch.
It fits all rods less than 1.7 inch thickness.
Each wallet hanger weight 0.06lbs,
Strong enough to Hold up to 22lbs

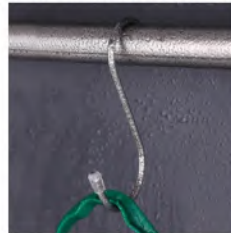

Excellent Quality Purse Hanger
They are well built.
Made of sturdy metal (no snapping or bending)
but also have a plastic coating on the outside. So they don't rust or scratch your walls or your belongings.

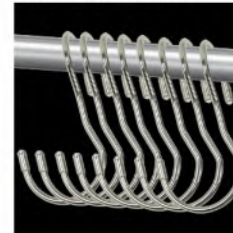

Heavy Duty S Hooks, Great Space Saver
Include 12PC Purse Hanger Hooks
These S hooks are highly versatile and can work in a large number of environments
Can be used to hang clothes, pants, bags, belts, ties, hats, scarves, towels, pots, pans, cups, kitchen utensils and so on.

Videos

Videos for related products



Upload your video

Looking for specific info?

Search in reviews, Q&A...

Product information

Color	Silver
Brand	DSVENROLY
Material	Alloy Steel, Plastic, Rubber
Special Feature	Anti Rust
Number of Pieces	12
Number of Items	12
Package Dimensions	5.2 x 2.8 x 2.52 inches
Item Weight	1.06 ounces
Manufacturer	DSVENROLY
ASIN	B0B53CKGZ7
Customer Reviews	4.7 4 ratings 4.7 out of 5 stars
Best Sellers Rank	#1,435,290 in Industrial & Scientific (See Top 100 in Industrial & Scientific) #10,590 in Utility Hooks #17,057 in Industrial Hooks #575,561 in Hardware
Date First Available	June 25, 2022

Feedback
Would you like to [tell us about a lower price?](#)

Important information

To report an issue with this product, [click here](#).

Products related to this item

Page 1 of 9

Sponsored

- Purse Hanger for Closet, Unique Twist Design Bag Hanger Purse Hooks, Large Size Clo...**
★★★★☆ 37
\$9.99 (\$0.83/Count)
- Hanger Connector Hooks, Space Saving Hanger Hooks for Organizer Closet, 18...**
★★★★☆ 112
\$8.97 (\$0.50/Count)
- GEFTOL Space Saving Hangers Metal Hanger Magic Cascading Hanger Closet Clothes Orga...**
★★★★☆ 8,319
\$7.99 (\$2.00/Count)
- Belt Hanger, HOMEBROS Silver 360° Rotatable Metal Belt Rack Organizer for Closet Sp...**
★★★★☆ 33
\$7.99
- CTOHN 20 Pack Purse Hanger for Closet, Unique Twist Design Bag Hanger Purse Hooks, ...**
★★★★☆ 17
\$9.98 (\$0.50/Count)
- 12 Pack Purse Hanger for Closet, Unique Twist Design, Large Size Closet Rod Hooks fo...**
\$9.39 (\$0.78/Count)
- BCISWOS Purse Hanger for Closet, 10 Pack Handbag Hanger Organizer Unique...**
★★★★☆ 30
\$6.99

Colgate Total Plaque Pro Release Whitening Toothpaste, 3.0 Oz Tube (1 Pack)
★★★★☆ 2,811
\$7.96
[Details & delivery](#)
[Add to Cart](#)

†As a regular fluoride toothpaste with twice daily brushing for 6 months.

Sponsored

Customer reviews

★★★★☆ 4.7 out of 5

4 global ratings

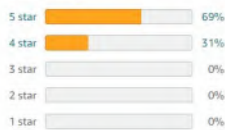

How customer reviews and ratings work

No customer reviews

There are 0 customer reviews and 4 customer ratings.







Review this product

Share your thoughts with other customers

GLUIT Large Adhesive Hooks Heavy Duty 2...
Shop now >
\$14.99

Sponsored

Based on your recent shopping trends

 <p>Fitnice 10 Pack Purse Hanger for Closet, 5 Hooks for Hanging Twisted Purse Hooks... ★★★★★ 184 Amazon's Choice in Utility Hooks \$9.99 (\$1.00/Count) Get it as soon as Monday, Nov 20 FREE Shipping on orders over \$35 shipped by Amazon</p>	 <p>HiGift 8 Pack Purse Hanger for Closet, Unique Twist Design... ★★★★★ 457 Save 11% \$7.99 List: \$8.99 Lowest price in 30 days Get it as soon as Sunday, Nov 19 FREE Shipping on orders over \$35 shipped by Amazon</p>	 <p>SAVITA 10pcs Purse Hooks for Closet, Heavy Duty Black S Hooks for Hanging Clothes in a Closet Handbags Twist... ★★★★★ 70 \$11.99 (\$1.20/Count) Get it as soon as Tuesday, Nov 21 FREE Shipping on orders over \$35 shipped by Amazon Only 13 left in stock - order...</p>	 <p>BICISIWOS Purse Hanger for Closet, 10 Pack Handbag Hanger... ★★★★★ 30 Save 8% \$6.99 Typical: \$7.59 Lowest price in 30 days Get it as soon as Sunday, Nov 19 FREE Shipping on orders over \$35 shipped by Amazon</p>	 <p>12 Pack Purse Hangers for Closet, Unique Twisted Purse Hooks, Black Closet Rod S Hooks for Hanging... ★★★★★ 129 \$11.99 (\$1.00/Count) Get it as soon as Wednesday, Nov 22 FREE Shipping on orders over \$35 shipped by Amazon</p>	 <p>12 Pack Purse Hanger for Closet, Twist Design Bag Hanger Purse Hoo... ★★★★★ 17 Save 9% \$9.99 Typical: \$10.99 Lowest price in 30 days Get it as soon as Monday, Nov 20 FREE Shipping on orders over \$35 shipped by Amazon</p>	 <p>Hooks Twisted S Hooks for Closet Rod Hooks for Handbags, Bags, Clothes, P... ★★★★★ 353</p>
---	--	---	--	---	--	---

DISSOLVES & LIFTS AWAY GUM HARMING PLAQUE WITH DAILY BRUSHING









Colgate Total Plaque Pro Release Whitening Toothpaste
 \$7.56 ~~\$8.99~~ **prime**
Save 5% more with Subscribe & Save



Back to top

<p>Get it as soon as Wednesday, Nov 22 FREE Shipping by Amazon</p>	<p>Get it as soon as Sunday, Nov 19 FREE Shipping on orders over \$35 shipped by Amazon</p>	<p>Nov 19 FREE Shipping by Amazon</p>	<p>Get it as soon as Sunday, Nov 19 FREE Shipping on orders over \$35 shipped by Amazon</p>	<p>Nov 19 FREE Shipping on orders over \$35 shipped by Amazon</p>	<p>\$17.00 List: \$39.99 Get it as soon as Sunday, Nov 19 FREE Shipping on orders over \$35 shipped by Amazon</p>
--	---	---	---	---	---

Customers who viewed items in your browsing history also viewed

 <p>12 Pack Purse Hanger for Closet, Unique Twist Design Bag Hanger Purse Hooks, Large Size Clos... ★★★★★ 1,307 Amazon's Choice in Tie Racks \$9.69 (\$0.81/Count) Get it as soon as Sunday, Nov 19 FREE Shipping on orders over \$35 shipped by Amazon</p>	 <p>Purse Hanger Organizer for Closet, S Hooks Twist Design Bag Hanger, Closet Rod Hooks for Hanging... ★★★★★ 439 \$8.98 (\$1.12/Count) Get it as soon as Sunday, Nov 19 FREE Shipping on orders over \$35 shipped by Amazon</p>	 <p>Fitnice 10 Pack Purse Hanger for Closet, S Hooks for Hanging Twisted Purse Hooks Heavy Duty S Hooks... ★★★★★ 184 \$9.99 (\$1.00/Count) Get it as soon as Monday, Nov 20 FREE Shipping on orders over \$35 shipped by Amazon</p>	 <p>ZEDODIER 14 Pack Purse Hooks for Closet, Backpack Hanger Bag Holder, Closet Accessories Organizer... ★★★★★ 100 \$7.99 (\$0.57/Count) Get it as soon as Sunday, Nov 19 FREE Shipping on orders over \$35 shipped by Amazon</p>	 <p>BESARME 15 Pack Purse Hanger for Closet, Unique Twist Design Bag Hanger Hooks, Purse... ★★★★★ 314 Amazon's Choice in Utility Hooks \$9.99 (\$0.67/Count) Get it as soon as Sunday, Nov 19 FREE Shipping on orders over \$35 shipped by Amazon</p>	 <p>Myfolrenea Purse Hangers Bag Hooks Closet- 12 Pack Handbag Hanger Organizer Metal S Hooks, Large Size Clos... ★★★★★ 229 \$9.99 Get it as soon as Sunday, Nov 19 FREE Shipping on orders over \$35 shipped by Amazon</p>
---	--	---	---	---	--

See personalized recommendations

[Sign in](#)

New Customer? Start here.

Back to top

<p>Get to Know Us</p> <ul style="list-style-type: none"> Careers Amazon Newsletter About Amazon Accessibility Sustainability Press Center Investor Relations Amazon Devices Amazon Science 	<p>Make Money with Us</p> <ul style="list-style-type: none"> Sell on Amazon Sell apps on Amazon Supply to Amazon Protect & Build Your Brand Become an Affiliate Become a Delivery Driver Start a Package Delivery Business Advertise Your Products Self-Publish with Us Host an Amazon Hub 	<p>Amazon Payment Products</p> <ul style="list-style-type: none"> Amazon Visa Amazon Store Card Amazon Secured Card Amazon Business Card Shop with Points Credit Card Marketplace Reload Your Balance Gift Cards Amazon Currency Converter 	<p>Let Us Help You</p> <ul style="list-style-type: none"> Your Account Your Orders Shipping Rates & Policies Amazon Prime Returns & Replacements Manage Your Content and Devices Your Recalls and Product Safety Alerts Help
--	---	--	---

See More Ways to Make Money



English

United States

Amazon Music
Stream millions of songs

Amazon Ads
Reach customers wherever they spend their time

Epm
Score deals on fashion brands

AbeBooks
Books, art & collectibles

ACX
Audiobook Publishing Made Easy

Sell on Amazon
Start a Selling Account

Amazon Business
Everything For Your Business

Amp
Host your own live radio show with music you love

Amazon Fresh
Groceries & More Right To Your Door

AmazonGlobal
Ship Orders Internationally

Home Services
Experienced Pros Happiness Guarantee

Amazon Web Services
Scalable Cloud Computing Services

Audible
Listen to Books & Original Audio Performances

Box Office Mojo
Find Movie Box Office Data

Goodreads
Book reviews & recommendations

IMDb
Movies, TV Shows & Celebrities

IMDbPro
Get Info Entertainment Professionals Need

Kindle Direct Publishing
Publish Indie Digital & Print Publishing Made Easy

Amazon Photos
Unlimited Photo Storage Free With Prime

Prime Video Direct
Video Distribution Made Easy

Shopbop
Designer Fashion Brands

Amazon Warehouse
Great Deals on Quality Used Products

Whole Foods Market
America's Healthiest Grocery Store

Woot!
Deals and Shenanigans

Zappos
Shoes & Clothing

Ring
Smart Home Security Systems

eero WiFi
Stream 4K Video in Every Room

Blink
Smart Security for Every Home

Neighbors App
Real-Time Crime & Safety Alerts

Amazon Subscription Boxes
Top subscription boxes - right to your door

PillPack
Pharmacy Simplified

Amazon Renewed
Like-new products you can trust

Fourth Webpage Showing Sale of Infringing
Product Type 3



BeneLabel String Light Hooks \$12.99 prime

Home & Kitchen > Storage & Organization > Home Storage Hooks > Utility Hooks

PRODUCT SIZE Size:11.30X5.70X5.70cm/4.44X2.24X2.24inch

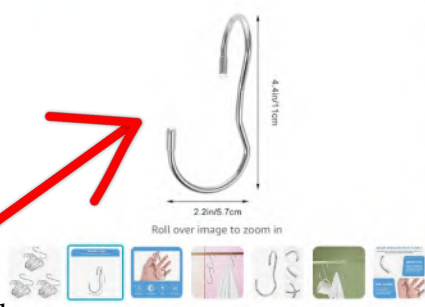

Infringing Product Type 3

Housoutil 24 Pcs Torsion s Hook Closet Purse Hanger Plain Tote Bag Purse Holder S Shape Closet Hook Closet Bag Hanger Heavy Duty Hangers for Clothes Black Wallet Bags Stainless Steel Handbag

\$38.89

Best price

Get \$60 off instantly: Pay \$0.00 \$38.89 upon approval for the Amazon Store Card. No annual fee.

Color: Silverx3pcs



See available options

See all 16 options >

Size: 11.3X5.7cmx3pcs



Color: Silverx3pcs
Material: Metal
Brand: Housoutil
Item Weight: 738 Grams
Item Dimensions LxWxH: 4.45 x 6.73 x 2.24 inches

About this item

- Handbag Hangers: Can be used for hanging clothes, purse, keys, coats, hats, bags, small items, etc.
- Hooks For Hanging Coats: Light weight, proper size, reasonable arc design, the hook makes your life convenient.
- Stainless Hanging Hook: Stainless steel materials structure, not easy to rust, being very stable and not easy to deform or.
- Hook For Storage: The supple ends can bags from scratches, bring you satisfying using feeling.
- Stainless Hanging Hooks: Can be widely applied for hanging handbags, backpacks, belts, ties, jeans, tops, boots, scarves, plants, pots and pans.

See more product details

Sponsored Evob Stylish, Efficient Storage Solution 30 Black S Hooks, Heavy Duty, Metal... \$7.47 prime

\$38.89 FREE delivery November 27 - December 7. Details Delivering to Albany 12201 - Update location In Stock Qty: 1 Add to Cart Buy Now Ships from Entertainment First Sold by Entertainment First Returns Returnable until Jan 31, 2024 Payment Secure transaction Add to List

Sponsored Weixinger's Screw Hooks, Black, Heavy Duty, Multifunctional... \$12.99 prime

Buy it with

Three items with checkboxes: Housoutil 24 Pcs Torsion s Hook Closet Purse Hanger Plain Tote Bag Purse... \$38.89; EZifego Double Sided Tape Heavy Duty, Extra Large Nano Double Sided Adhesive Tape, Clear... \$9.99 (\$0.08/Item); FYY Over the Door Hooks, 4 Pack Hangers Hooks with Rubber Prevent Scratches Heavy Duty... \$7.95 (\$1.99/Count)

Total price: \$56.83 Add all 3 to Cart

These items are shipped from and sold by different sellers. Show details

Based on your recent shopping trends

SAVITA 10pcs Purse Hooks for Closet, Heavy Duty Black 5 Hooks for Hanging Clothes in a Closet Handbags Twist...
 ★★★★★ 70
 \$11.99 (\$1.20/Count)
 Get it as soon as **Tuesday, Nov 21**
 FREE Shipping on orders over \$35 shipped by Amazon
 Only 13 left in stock - order...

HIGift 8 Pack Purse Hanger for Closet, Unique Twist Design...
 ★★★★★ 457
Save 11%
 List: \$6.99
 \$7.99
 Lowest price in 30 days
 Get it as soon as **Sunday, Nov 19**
 FREE Shipping on orders over \$35 shipped by Amazon

Fitnice 10 Pack Purse Hanger for Closet, 5 Hooks for Hanging Twisted Purse Hooks Heavy Duty 5 Hooks...
 ★★★★★ 184
 \$9.99 (\$1.00/Count)
 Get it as soon as **Monday, Nov 20**
 FREE Shipping on orders over \$35 shipped by Amazon

ZEDODIER 14 Pack Purse Hooks for Closet, Backpack Hanger Bag Holder, Closet...
 ★★★★★ 100
Amazon's Choice in Utility Hooks
 \$7.99 (\$0.57/Count)
 Get it as soon as **Sunday, Nov 19**
 FREE Shipping on orders over \$35 shipped by Amazon

BCISHWOS Purse Hanger for Closet, 10 Pack Handbag Hanger...
 ★★★★★ 50
Save 8%
 \$6.99
 Typical: \$7.99
 Lowest price in 30 days
 Get it as soon as **Sunday, Nov 19**
 FREE Shipping on orders over \$35 shipped by Amazon

12 Pack Purse Hangers for Closet, Unique Twisted Purse Hooks, Black Closet Rod 5 Hooks for Hanging...
 ★★★★★ 129
 \$11.99 (\$1.00/Count)
 Get it as soon as **Wednesday, Nov 22**
 FREE Shipping on orders over \$35 shipped by Amazon

12 Pack Handbag Hanger Organizer Metal 5 Hooks, Large Size Clos...
 ★★★★★ 229
 \$9.99
 Get it as soon as **Sunday, Nov 19**
 FREE Shipping on orders over \$35 shipped by Amazon

Overstock deals on Home Storage Hooks Explore more in Outlet

6 Pack Rustic Cast Iron Coat Hooks Heart Shape Outdoor Wall Hooks Wall Mount with Scre...
 ★★★★★ 12
30% off Overstock
 \$11.19 (\$1.87/Count)
 Typical: \$15.99
 Get it as soon as **Sunday, Nov 19**
 FREE Shipping on orders over \$35 shipped by Amazon
 Only 4 left in stock - order...

Franklin Brass Double Scroll Hook Assembly Wall Hooks 5-Pack,...
 ★★★★★ 1,428
Amazon's Choice in Coat Hooks
12% off Overstock
 \$25.30 (\$5.06/Count)
 Typical: \$28.99
 Get it as soon as **Sunday, Nov 19**
 FREE Shipping on orders over \$35 shipped by Amazon

AOAOYING 10 Pcs Wall Mounted Coat Hooks, Hanger Hook with 20 Pieces Screws for Towe...
 ★★★★★ 2
50% off Overstock
 \$6.49 (\$1.84/Count)
 List: \$12.99
 Get it as soon as **Monday, Nov 20**
 FREE Shipping on orders over \$35 shipped by Amazon
 Only 12 left in stock - order...

IYSOJSLUNN 4PCS Kitchen Utensil Holder Hooks Heavy Duty, Plastic Self-Adhesive...
 ★★★★★ 54
50% off Overstock
 \$7.49 (\$1.87/Count)
 List: \$14.99
 Get it as soon as **Sunday, Nov 19**
 FREE Shipping on orders over \$35 shipped by Amazon

HAMOPY Mail Organizer Wall Mount with 5 Key Hooks, 20 Inch Shelf with Hooks, Chalkboar...
 ★★★★★ 17
20% off Overstock
 \$21.59
 Typical: \$26.99
 Get it as soon as **Wednesday, Nov 22**
 FREE Shipping on orders over \$35 shipped by Amazon

LEMONIDEA Wall Mounted Hook Rack Elegant Metal Folding Floating 5 Hanger Rail ...
 ★★★★★ 34
50% off Overstock
 \$9.99
 Typical: \$19.99
 Get it as soon as **Monday, Nov 20**
 FREE Shipping on orders over \$35 shipped by Amazon

Looking for specific info?

Search in reviews, Q&A...

Videos

Help others learn more about this product by uploading a video!

Upload your video

Product information

Technical Details

Manufacturer	Housoutil
Part Number	F4203LKWQ6E5R5EQUN37QIUZ
Item Weight	1.63 pounds
Product Dimensions	4.45 x 6.73 x 2.24 inches
Country of Origin	China
Item model number	F4203LKWQ6E5R5EQUN37QIUZ
Size	11.3X5.7cmx3pcs
Color	Silverx3pcs
Style	fashion
Finish	Chrome
Material	Metal
Voltage	319 Volts
Item Package Quantity	1
Number Of Pieces	24
Coverage	18/09/2027
Mounting Type	Desk Mount
Included Components	hook
Batteries Included?	No
Batteries Required?	No

Additional Information

ASIN	B0BFRN643S
Best Sellers Rank	#3,289,198 in Home & Kitchen (See Top 100 in Home & Kitchen) #267,879 in Home Storage & Organization (Home & Kitchen)
Date First Available	September 19, 2022

Warranty & Support

Product Warranty: For warranty information about this product, please click here

Feedback

Would you like to tell us about a lower price? -

Product Description

Package List
8 x Purse Hangers

Characteristics

- Material: Stainless steel.
- The supple ends can bags from scratches, bring you satisfying using feeling.
- Light weight, easy to use and carry, can be widely applied for rods in bathroom, living room and more places.
- Made of stainless steel materials, this hanger is and durable, can be used for long time.
- Color: silver.
- Can be used for hanging clothes, purse, keys, coats, hats, bags, small items, etc.
- Reasonable design, allows you suspend your bags vertically in the closet, save spaces and choose bags more conveniently.
- Size: 11.30X5.70X5.70cm/ 4.44X2.24X2.24inch.

Goods Description

stainless hanging hook This is an excellent rod hanger for closet, bathroom, kitchen, living room, laundry room and places you want.hooks for hanging coats With its reasonable and scientific arc, practical use, it can be used for hanging bags, purse, handbag, scarf and so on.hook for storage These purse hangers are made from stainless steel material, safe, durable and you can use it for time

Important information

Bulb Voltage

319 volts

To report an issue with this product, click here.

Weixinghera Screw Hooks, Heavy Duty, Multifunctional, Black...
★★★★★ 20
\$12.99 prime

Sponsored

Similar brands on Amazon

Page 1 of 2

Sponsored

HOME DEPUTY Shop the Store on Amazon >
HOME DEPUTY 6 Pack Purse Organizers for Closet - 6 Bag Hooks - Silver - Purse...
★★★★★ 511
\$12.50 Typical: \$18.40

Wiscal Shop the Store on Amazon >
Purse Hanger Organizer for Closet 3 Pack - Durable Luxury Acrylic Holder for...
★★★★★ 449
\$29.99

SEEBRIDER Shop the Store on Amazon >
SEEBRIDER Purse Hanger Closet, Purse Holder for Closet Grey Backpack Hanger...
\$16.99

Customer reviews

No customer reviews



How customer reviews and ratings work

Review this product

Share your thoughts with other customers

Write a customer review

GLUTT Adhesive Hooks Shop now >
Heavy Duty 22 lbs...
\$9.99 prime

Sponsored

Brand in this category on Amazon

GINPIUK

Handbag dust bags

Shop GINPIUK

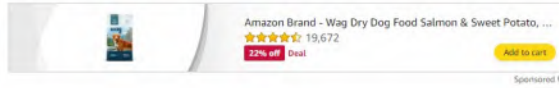
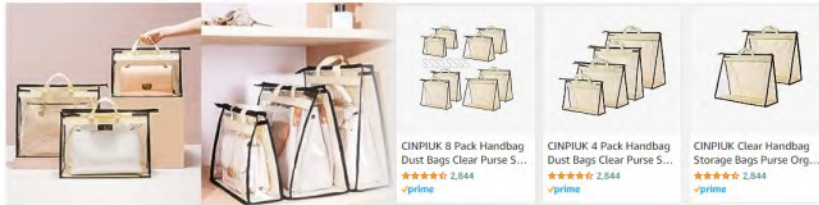

Sponsored

Back to top



Back to top

Get to Know Us

- Careers
- Amazon Newsletter
- About Amazon
- Accessibility
- Sustainability
- Press Center
- Investor Relations
- Amazon Devices
- Amazon Science

Make Money with Us

- Sell on Amazon
- Sell apps on Amazon
- Supply to Amazon
- Protect & Build Your Brand
- Become an Affiliate
- Become a Delivery Driver
- Start a Package Delivery Business
- Advertise Your Products
- Self-Publish with Us
- Host an Amazon Hub
- See More Ways to Make Money

Amazon Payment Products

- Amazon Visa
- Amazon Store Card
- Amazon Secured Card
- Amazon Business Card
- Shop with Points
- Credit Card Marketplace
- Reload Your Balance
- Gift Cards
- Amazon Currency Converter

Let Us Help You

- Your Account
- Your Orders
- Shipping Rates & Policies
- Amazon Prime
- Returns & Replacements
- Manage Your Content and Devices
- Your Recalls and Product Safety Alerts
- Help

amazon

English

United States

Amazon Music
Stream millions of songs

Amp
Host your own live radio show with music you love

Goodreads
Book reviews & recommendations

Amazon Warehouse
Great Deals on Quality Used Products

Amazon Ads
Reach customers wherever they spend their time

Amazon Fresh
Groceries & More Right To Your Door

IMDbPro
Movies, TV & Celebrities

Whole Foods Market
America's Healthiest Grocery Store

Neighbors App
Real-Time Crime & Safety Alerts

Spin
Score deals on fashion brands

AmazonGlobal
Shop Online Internationally

IMDbPro
Get Info Entertainment Professionals Need

Woot!
Deals and Shengangs

Amazon Subscription Boxes
Top subscription boxes right to your door

AbelBooks
Books, art & collectibles

Home Services
Experienced Pros. Happiness Guarantee

Kindle Direct Publishing
Indie Digital & Print Publishing Made Easy

Zappos
Shoes & Clothing

PillPack
Pharmacy Simplified

ACX
Audiobook Publishing Made Easy

Amazon Web Services
Scalable Cloud Computing Services

Amazon Photos
Unlimited Photo Storage Free With Prime

Ring
Smart Home Security Systems

Amazon Renewed
Like-new products you can trust

Sell on Amazon
Start a Selling Account

Audible
Listen to Books & Original Audio Performances

Prime Video Direct
Video Distribution Made Easy

eero WiFi
Stream 4K Video in Every Room

Blink
Smart Security for Every Home

Amazon Business
Everything For Your Business

Box Office Mojo
Find Movie Box Office Data

Shopbop
Designer Fashion Brands

EXHIBIT P
Mesiti Declaration
Infringing Product Type 4 Webpages

First Webpage Showing Sale of Infringing
Product Type 4

Home & Kitchen > Storage & Organization > Clothing & Closet Storage > Clothes Hangers > Standard Hangers

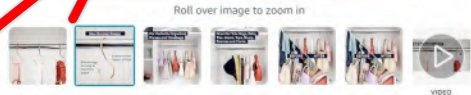

HOME DEPUTY Purse Organizer for Closet - 6 Bag Hooks - Rose Gold - Purse Hangers for Closet with Unique Twisted Hook Design which Saves Space - Your Handbags Will Look Great in Your Closet

Visit the HOME DEPUTY Store 4.8 511 ratings

Lowest price in 30 days -7% \$12.50 (\$2.08 / Count)

Typical price: \$14.50 @

Get Fast, Free Shipping with Amazon Prime

FREE Returns

Best price

Get a \$60 gift card instantly. Pay \$0.00 \$42.50 upon approval for the Amazon Store Card. Find out how



Table with columns: Color, Material, Brand, Item Dimensions, Mounting Type. Values: Rose Gold, Metal, HOME DEPUTY, 1.77 x 1.77 x 3.94 inches, Desk Mount.

- About this item: Purse Hooks for Closet: No more dusty floors or hard to reach places for your precious handbags and purses; Not only is this a space-efficient storage solution... Unique Design: We have taken the classic S hook and twisted it so that you can display your handbags and purses side by side... Stylish and on-trend: Not only do these shiny classic rose gold closet hooks look gorgeous, they are also strong, will hold up to 10kg and fits all closet rods... It isn't just a purse organizer: These hooks are also the perfect organizer all your accessories such as Tote Bags, Backpacks, Belts, Ties, Jeans, Tops, Boots and Scarves... Buy With Confidence: Our Purse Hanger will keep you organized for years to come...

Customer ratings by feature: Durability (4.7), Sturdiness (4.7), Value for money (4.6)

Consider a similar item: Amazon's Choice: HOUSE DAY Black Magic Space Saving Hangers, Premium Smart Hanger Hooks, Sturdy Cascading Hangers with 5 Holes for Heavy Clothes, Closet Organizers and Storage, College Dorm Room Essentials 10 Pack. \$9.99 (\$1.00/Count)

Non-Slip Space Saving Heavy Duty Velvet Hangers. HOUSE DAY Beige Saving Heavy Velvet Hangers 60... \$31.99 prime

prime Enjoy fast, FREE delivery, exclusive deals and award-winning movies & TV shows with Prime. Try Prime and start saving today with Fast, FREE Delivery

\$12.50 (\$2.08 / Count) Get Fast, Free Shipping with Amazon Prime FREE Returns

FREE delivery Monday, November 20 on orders shipped by Amazon over \$35

Or fastest delivery Thursday, November 16. Order within 11 hrs 23 mins

In Stock

Qty: 1 Add to Cart Buy Now

Ships from Amazon Sold by HOME DEPUTY Returns Returnable until Jan 31, 2024

Add to List

Non-Slip Space Saving Heavy Duty Velvet Hangers. 60 Pink Velvet Hangers, Premium Non-Slip Felt Clothes, Sturdy Heavy... \$31.99 prime

Infringing Product Type 4

Frequently bought together

Product recommendations: This item: HOME DEPUTY Purse Organizer for Closet - 6 Bag Hooks - Rose Gold - Purse... ZEDODIER Purse Hanger Organizer for Closet, 2 Pack Hanging Bag Holder... SONGMICS Velvet Hangers, Set of 50 Clothes Hanger with Rose Gold Swivel Hook, Non-Slip, and Spac...

Total price: \$54.46 Add all 3 to Cart

These items are shipped from and sold by different sellers. Show details

\$12.50 (\$2.08/Count)







\$11.99 (\$6.00/Count)

\$29.97 (\$0.60/Count)

4 stars and above

Page 1 of 50







Sponsored

 <p>ZEDODIER Purse Hanger Organizer for Closet, 2 Pack Hanging Bag Holder, Keeping Purse... ★★★★☆ 3,207 \$11.99 (\$6.00/Count) prime</p>	 <p>PODATOL Bra Organizer, 2 Pack Tank Top Hanger for Closet Swivel Hook Foldable Desig... ★★★★★ 564 Limited time deal \$7.49 (\$1.75/Count) prime List: \$14.99 (50% off)</p>	 <p>CINPLUK Purse Hanger for Closet - Rotating Handbag Hanging Hook Bag Storage Space S... ★★★★☆ 195 \$14.99 prime</p>	 <p>Myfolrena Purse Hangers Bag Hooks Closet- 12 Pack Handbag Hanger Organizer Metal S ... ★★★★☆ 227 \$9.99 prime</p>	 <p>Purse Hanger Purse Organizer for Closet, 5 Hooks Twist Design Bag Hanger, Closet Rod ... ★★★★☆ 439 \$8.98 (\$1.12/Count) prime</p>	 <p>Heavy Duty Plastic Hangers 50 Pack with Non-Slip Design, 0.2 Inches... ★★★★☆ 980 \$29.99 (\$59.98/Count) prime</p>	 <p>Purse Hanger Organizer for Closet 2-Pack, Fitnice Metal Handbag Hangers Space Savin... ★★★★☆ 57 \$9.99 (\$5.00/Count) prime Save 10% with coupon</p>
--	---	--	---	---	--	--

More from frequently bought brands

Page 1 of 22

Sponsored

 <p>AMKUF0 Hangers- Space-Saving-12 Pack - Closet-Organizers-and-Storage for Dorm... ★★★★☆ 78 \$11.99 (\$1.00/Count) prime</p>	 <p>ZEDODIER Purse Hanger Organizer for Closet, 2 Pack Hanging Bag Holder, Keeping Purse... ★★★★☆ 3,207 \$11.99 (\$6.00/Count) prime</p>	 <p>ZEDODIER Purse Hanger Organizer for Closet, 2 Pack Rotatable Hanging Bag Holder, Ke... ★★★★☆ 213 \$12.99 (\$6.50/Count) prime</p>	 <p>Ulimart 12 Pack Space-Saving-Hangers,Sturdy-Hanger-Organizer-Metal-Closet-Organizer... ★★★★☆ 417 \$16.99 (\$1.42/Count) prime</p>	 <p>Heavy Duty Plastic Hangers 50 Pack with Non-Slip Design, 0.2 Inches... ★★★★☆ 980 \$29.99 (\$59.98/Count) prime</p>	 <p>ZEDODIER 2 Pack Tank Top Hanger, Space Saving Bra Hangers, Non-Slip Hanging... ★★★★☆ 5,552 \$14.99 (\$7.50/Count) prime</p>	 <p>HOUSE DAY Space Saving Hangers Black, Smart Closet Organizer Space Saver, Sturdy PL... ★★★★☆ 32,106 \$19.99 (\$1.25/Count) prime Climate Pledge Friendly</p>
--	--	---	---	---	---	--

Product Description



PURSE HANGING HOOKS

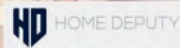

Working out the perfect storage solution for your purses has always been a conundrum...if you put them in a storage bin, they will lose shape; if you put them under the bed, they'll be out of sight (and out of mind) and if you store them at the bottom of your closet, they will get dusty.

We have the perfect solution - the Home Deputy Purse Hanging Hooks for your closet.

The unique design of the twist on the classic S hook means you can hang your handbags side by side alongside your clothes providing the perfect space-saving storage solution.



BEFORE

AFTER



UNIQUE DESIGN
We have taken the classic S hook and twisted it so that you can display your handbags and purses side by side at eye level

STYLISH & ON TREND
Will make your closet look great by organizing your purses side by side.

MULTIPURPOSE
The perfect organizer all your accessories such as Tote Bags, Backpacks, Belts, Ties, Jeans, Tops, Boots, Scarves and Camis

AVAILABLE IN 4 ON-TREND COLOURS

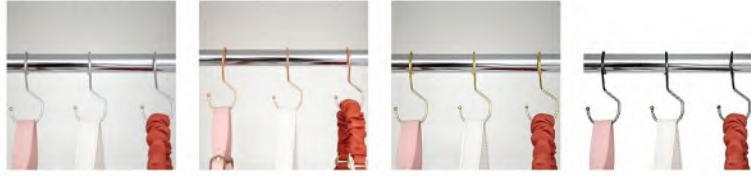

SILVER ROSE GOLD GOLD BLACK



PURSE HANGING HOOKS

- 6 Pack
- Comes in Silver, Rose Gold, Gold and Black
- Use for purses and handbags
- Fits all closet rods

ABOUT HOME DEPUTY

We're a small, family business that believes that everyone should live in a home they love and that home improvement need not be a costly nor daunting exercise. Quality products should be cost effective and accessible to everyone! We design and develop unique products that give you the confidence to personalize your home on a budget.

Looking for specific info?

Videos

Videos for related products

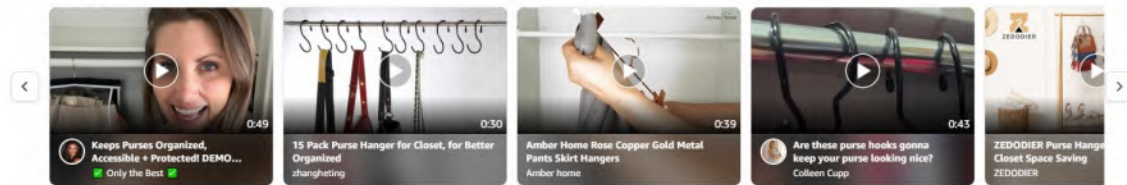

Upload your video

Product information

Product Dimensions	1.77 x 1.77 x 3.94 inches
Item Weight	3.2 ounces
Department	womens
Manufacturer	Home Deputy
ASIN	B08Q33TD6N
Item model number	HBH-RG
Customer Reviews	4.8 511 ratings 4.8 out of 5 stars
Best Sellers Rank	#95,596 in Home & Kitchen (See Top 100 in Home & Kitchen) #199 in Standard Hangers
Date First Available	July 10, 2021

Warranty & Support

Product Warranty: For warranty information about this product, please click here

Feedback

Would you like to [tell us about a lower price?](#)

Compare with similar items

This item HOME DEPUTY Purse Organizer for Closet - 6 Bag Hooks - Rose Gold - Purse Hangers for Closet with Unique Twisted Hook Design which Saves Space - Your Handbags Will Look Great in Your Closet	12 Pack Purse Hanger for Closet, Unique Twist Design Bag Hanger Purse Hooks, Large Size Closet Rod Hooks for Hanging Necklace Bags, Purse, Handbags, Belts, Scarves, Hats, Clothes, Pans and Pots, Black	ZEDODIER 14 Pack Purse Hooks for Closet, Backpack Hanger Bag Holder, Closet Accessories Organizer 5 Hook for Hanging Purse, Handbags, Bags, Belts, Scarves, Hats, Clothes, and Plant, Rose Gold	Purse Hanger Organizer for Closet 3 Pack - Durable Luxury Acrylic Holder for Handbag Tote Bag Satchel Backpack Crossover - Holds Up to 66Lbs - Easy to Clean, No Tools Required	ZEDODIER Purse Hanger Organizer for Closet, 2 Pack Hanging Bag Holder, Keeping Purse Visible and in Good Condition, Metal Handbag Storage Hook Backpack Rack Space Saving Hanger, Rose Gold
Add to Cart	Add to Cart	Add to Cart	Add to Cart	Add to Cart
Customer Rating ★★★★★ (511)	★★★★☆ (1307)	★★★★★ (100)	★★★★★ (449)	★★★★★ (3207)
Price \$12.50	\$9.99	\$7.99	\$29.99	\$11.99
Shipping FREE Shipping on orders over \$35.00 shipped by Amazon or get Fast, Free Shipping with Amazon Prime	FREE Shipping on orders over \$35.00 shipped by Amazon or get Fast, Free Shipping with Amazon Prime	FREE Shipping on orders over \$35.00 shipped by Amazon or get Fast, Free Shipping with Amazon Prime	FREE Shipping on orders over \$35.00 shipped by Amazon or get Fast, Free Shipping with Amazon Prime	FREE Shipping on orders over \$35.00 shipped by Amazon or get Fast, Free Shipping with Amazon Prime
Sold By HOME DEPUTY	LiteViso	ZEDODIER	kankoki	ZEDODIER
Color Rose Gold	Black	Rose Gold	Clear	Rose Gold
Material Metal	Rubber, Alloy Steel	Metal	Acrylic	Metal

Inspiration from this brand

HOME DEPUTY
Visit the Store on Amazon

[+ Follow](#)

Some handbags are too pretty to be hidden away.

Fly your flag proudly day AND night 🌟

Maybe stuffing all my handbags into my closet and hoping for the best...

Our customers are loving the Home Deputy Solar Star lighting up their...

Handbags - out of sight, out of mind? They deserve to be on display!

Make yo complia

Videos for this product

PURSE HANGING HOOKS

0:45

Purse Hanger Hooks - Organize Purse and Handbags in style!
HOME DEPUTY

Important information

To report an issue with this product, click here.

Related products with free delivery on eligible orders

Page 1 of 58

Sponsored | Try Prime for unlimited fast, free shipping

Purse Hanger for Closet, Unique Twist Design Bag Hanger Purse Hooks, Large Size Clo...
★★★★★ 37
\$9.99 (\$0.83/Count)
[prime](#)

KWOKWEI Metal Clothes Hanger Connector Hooks, 50PCS Hanger Extender Hooks, ...
★★★★★ 5
\$16.99 [prime](#)

Zebriolo, purse organizer for closet, 2 Pack, purse organizer, Larger Pockets, pur...
★★★★★ 1,097
\$16.99 (\$8.50/Count)
[prime](#)

BCISWOS Purse Hanger for Closet, 10 Pack Handbag Hanger Organizer Unique...
★★★★★ 30
\$6.99 [prime](#)

CoHoXYY Acrylic Purse Hanger Closet Keep Your Totes and Backpacks Organized and in...
★★★★★ 31
\$18.58 (\$4.65/Count)
[prime](#)
Save 20% with coupon

Purse Hanger Purse Organizer for Closet, 5 Hooks Twist Design Bag Hanger Closet Rod ...
★★★★★ 439
\$8.98 (\$1.12/Count)
[prime](#)

Heavy Duty Plastic Hangers 50 Pack with Non-Slip Design, 0.2 Inches...
★★★★★ 980
\$29.99 (\$59.98/Count)
[prime](#)



Non-Slip Space Saving Heavy Duty Velvet Hangers
60 Pink Velvet Hangers, Premium Non-Slip Felt...
★★★★★ 16,445
\$31.98 prime

Sponsored

Similar brands on Amazon

Sponsored

MIZGI
Shop the Store on Amazon >



MIZGI Velvet Hangers (50 Pack) Heavy Duty - Non Slip Felt Hangers - Blush Plin...
★★★★★ 24,745
\$26.95 List: \$42.99
18% off Deal

HOME DEPUTY
Shop the Store on Amazon >

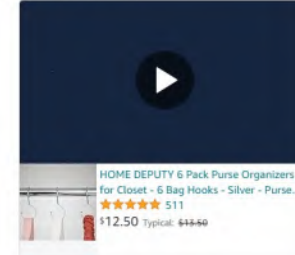

HOME DEPUTY 6 Pack Purse Organizers for Closet - 6 Bag Hooks - Silver - Purse...
★★★★★ 511
\$12.50 Typical: \$14.99

TIMMY
Shop the Store on Amazon >

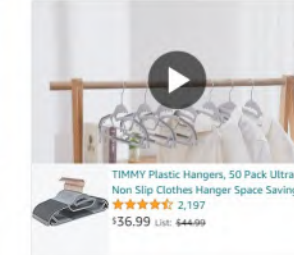

TIMMY Plastic Hangers, 50 Pack Ultra Thin Non Slip Clothes Hanger Space Saving...
★★★★★ 2,197
\$36.99 List: \$44.99

Customer reviews

★★★★★ 4.8 out of 5

511 global ratings

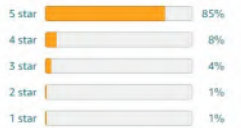

How customer reviews and ratings work

By feature

Durability ★★★★★ 4.7
 Sturdiness ★★★★★ 4.7
 Value for money ★★★★★ 4.6

Review this product

Share your thoughts with other customers

Write a customer review



Sponsored

Reviews with images

See all photos >



Read reviews that mention

- purse hooks
- works great
- looks great
- hang bags
- closet
- purse
- hangers
- hanging
- space
- rod
- taking

Top reviews

Top reviews from the United States

- Yanisell villa
 ★★★★★ **Good for small space**
 Reviewed in the United States on October 24, 2023
 Color: Rose Gold Verified Purchase
 For when you don't have space, it is a functional and wonderful idea.
 Helpful Report
- Frances
 ★★★★★ **Excellent Purse Hooks!**
 Reviewed in the United States on September 9, 2023
 Color: Silver Verified Purchase
 These purse hooks are very nice because they take up very little space in the closet. So you can hang a few purses without taking up alot of your closet space.
 Helpful Report
- HomeMaker
 ★★★★★ **Well designed and good quality**
 Reviewed in the United States on September 21, 2023
 Color: Silver Verified Purchase
 Love it
 Helpful Report
- K. Lee
 ★★★★★ **Space saving sturdy purse hooks!**
 Reviewed in the United States on July 2, 2023
 Color: Silver Verified Purchase
 These purse hooks are great, they hold your purses without taking up much space. The stainless steel hooks look sleek and well made. I highly recommend!
 Helpful Report
- Amazon Customer
 ★★☆☆☆ **Ok**
 Reviewed in the United States on June 26, 2023
 Color: Silver Verified Purchase
 Not what I expected
 Helpful Report

HLKNYC

★★★★★ **Perfect for vacation**

Reviewed in the United States on January 2, 2023

Color: Silver **Verified Purchase**

We go to Aruba on vacation where it can start pouring out of nowhere while you are away from your bags so we use these to hang the bags directly under the umbrella to keep them dry and off the floor. Worked perfectly. Also works to hang from back of beach chair.

Helpful Report

AmazonQueen

★★★★☆ **Very Sturdy Hooks**

Reviewed in the United States on September 21, 2022

Color: Black **Verified Purchase**

These hooks are solid and can hold heavy items. Good design and can stack next to each other hanging, if empty. Only downside is, is the price for 6 it's pretty expensive at \$15.99

Helpful Report

AZ Guy

★★★★★ **Great for organizing purses and belts.**

Reviewed in the United States on September 2, 2022

Color: Black **Verified Purchase**

I like the fact that I can get my backpacks and convertible backpack/purses up off the floor and organized. Since I only needed 4 of these hangers, my husband found a good use for the other two. His belts are now hanging rather than taking up shelf space. I thought the price was a bit high for these small hangers but they are a sturdy metal and do work well for us.



One person found this helpful

Helpful Report

See more reviews >

Top reviews from other countries

CC

★★★★★ **Really useful purse hooks**

Reviewed in Singapore on September 3, 2021

Color: Rose Gold **Verified Purchase**







Been looking for good hooks to hang up my bags for quite some time. This is the best solution yet.

Report

See more reviews >

Products related to this item







Sponsored

 <p>CoHoXXYY Acrylic Purse Hanger Closet Keep Your Totes and Backpacks Organized and in... ★★★★★ 31 \$18.58 (\$4.65/Count) prime Save 20% with coupon</p>	 <p>Purse Hanger for Closet, Unique Twist Design Bag Hanger Purse Hooks, Large Size Clo... ★★★★★ 37 \$9.99 (\$0.85/Count) prime</p>	 <p>Purse Hanger Purse Organizer for Closet, 5 Hooks Twist Design Bag Hanger, Closet Rod ... ★★★★★ 439 \$8.98 (\$1.12/Count) prime</p>	 <p>Heavy Duty Plastic Hangers 50 Pack with Non-Slip Design, 0.2 Inches... ★★★★★ 980 \$29.99 (\$0.98/Count) prime</p>	 <p>Purse Hanger Organizer for Closet 2-Pack, Fitnice Metal Handbag Hangers Space Savin... ★★★★★ 57 \$9.99 (\$5.00/Count) prime Save 50% with coupon</p>	 <p>SEEBRIDER Purse Hanger Closet, Purse Holder for Closet Grey Backpack Hanger Hook fo... \$16.99 prime Save 5% with coupon</p>	 <p>CTOHN 20 Pack Purse Hanger for Closet, Unique Twist Design Bag Hanger Purse Hooks, ... ★★★★★ 17 \$9.98 (\$0.50/Count) prime</p>
--	--	---	--	--	---	--







 <p>Non-Slip Space Saving Heavy Duty Velvet Hangers</p>	<p>HOUSE DAY Beige Velvet Hangers 60 Pack, Premium... ★★★★★ 16,445 \$31.99 prime</p>
--	--

Sponsored

Best Sellers in Industrial & Scientific Page 1 of 5

 <p>MedPride Powder-Free Nitrile Exam Gloves, Medium, Box/100 ★★★★★ 86,073 Low returns #1 Best Seller in Industrial & Scientific \$9.99 (\$0.10/Count) Get it as soon as Sunday, Nov 19 FREE Shipping on orders over \$35 shipped by Amazon</p>	 <p>iHealth COVID-19 Antigen Rapid Test, 1 Pack, 5 Tests Total, FDA EUA Authorized OTC a... ★★★★★ 19,056 #1 Best Seller in Clinical Diagnostic Test Kits \$44.95 (\$8.99/Count) Get it as soon as Sunday, Nov 19 FREE Shipping by Amazon</p>	 <p>Cascade Platinum Plus ActionPacs Dishwasher Detergent Pods, Fresh, 62 Count ★★★★★ 87,486 #1 Best Seller in Commercial Dishwasher Detergents \$17.59 (\$0.28/Count) Get it as soon as Wednesday, Nov 22 FREE Shipping on orders over \$35 shipped by Amazon</p>	 <p>Pampers Sensitive Baby Wipes - Baby Wipes Combo, 1008 Count, Water Based,... ★★★★★ 198,946 #1 Best Seller in Electronic Component Sensors \$34.97 (\$3.47/100 Count) Get it as soon as Sunday, Nov 19 FREE Shipping on orders over \$35 shipped by Amazon</p>	 <p>Med PRIDE NitrilPride Nitrile-Vinyl Blend Exam Gloves, Medium 100 - Powder Free, Latex Fre... ★★★★★ 40,932 Amazon's Choice in Medical Exam Gloves \$9.99 (\$0.10/Count) Get it as soon as Sunday, Nov 19 FREE Shipping on orders over \$35 shipped by Amazon</p>	 <p>SYLVANIA ECO LED Light Bulb, A19 60W Equivalent, Efficient 9W, 7 Year, 750 Lumens,... ★★★★★ 41,995 #1 Best Seller in LED Bulbs \$13.42 (\$1.68/Count) Get it as soon as Tuesday, Nov 21 FREE Shipping on orders over \$35 shipped by Amazon</p>
---	---	---	--	---	---

Customers who viewed items in your browsing history also viewed Page 1 of 6

 <p>12 Pack Purse Hanger for Closet, Unique Twist Design Bag Hanger Purse Hooks, Large Size Clos... ★★★★★ 1,307 Amazon's Choice in Tie Racks \$9.69 (\$0.81/Count) Get it as soon as Sunday, Nov 19 FREE Shipping on orders over \$35 shipped by Amazon</p>	 <p>Purse Hanger Purse Organizer for Closet, 5 Hooks Twist Design Bag Hanger, Closet Rod Hooks for Hanging... ★★★★★ 439 \$8.98 (\$1.12/Count) Get it as soon as Sunday, Nov 19 FREE Shipping on orders over \$35 shipped by Amazon</p>	 <p>Fitnice 10 Pack Purse Hanger for Closet, 5 Hooks for Hanging Twisted Purse Hooks Heavy Duty 5 Hooks... ★★★★★ 184 \$9.99 (\$1.00/Count) Get it as soon as Monday, Nov 20 FREE Shipping on orders over \$35 shipped by Amazon</p>	 <p>BESAREM 15 Pack Purse Hanger for Closet, Unique Twist Design Bag Hanger Hooks, Purse... ★★★★★ 314 Amazon's Choice in Utility Hooks \$9.99 (\$0.67/Count) Get it as soon as Sunday, Nov 19 FREE Shipping on orders over \$35 shipped by Amazon</p>	 <p>Myfolreina Purse Hangers Bag Hooks Closet- 12 Pack Handbag Hanger Organizer Metal 5 Hooks, Large Size Clos... ★★★★★ 229 \$9.99 Get it as soon as Sunday, Nov 19 FREE Shipping on orders over \$35 shipped by Amazon</p>	 <p>GEZIDEA Purse Hanger 5 Hooks Twisted 5 Hooks Closet Rod Hooks for Handbags, Clothes, P... ★★★★★ 353 \$13.42 (\$1.68/Count) Get it as soon as Tuesday, Nov 21 FREE Shipping on orders over \$35 shipped by Amazon</p>
--	---	--	--	--	--

See personalized recommendations
[Sign in](#)
New Customer? Start here.

Back to top

<p>Get to Know Us</p> <ul style="list-style-type: none"> Careers Amazon Newsletter About Amazon Accessibility Sustainability Press Center Investor Relations Amazon Devices Amazon Science 	<p>Make Money with Us</p> <ul style="list-style-type: none"> Start Selling with Amazon Sell apps on Amazon Supply to Amazon Protect & Build Your Brand Become an Affiliate Become a Delivery Driver Start a Package Delivery Business Advertise Your Products Self-Publish with Us Host an Amazon Hub See More Ways to Make Money 	<p>Amazon Payment Products</p> <ul style="list-style-type: none"> Amazon Visa Amazon Store Card Amazon Secured Card Amazon Business Card Shop with Points Credit Card Marketplace Reload Your Balance Gift Cards Amazon Currency Converter 	<p>Let Us Help You</p> <ul style="list-style-type: none"> Your Account Your Orders Shipping Rates & Policies Amazon Prime Returns & Replacements Manage Your Content and Devices Your Recalls and Product Safety Alerts Help
--	---	--	---

amazon English United States

<p>Amazon Music Stream millions of songs</p> <p>Amp Host your own live radio show with music you love</p> <p>Goodreads Book reviews & recommendations</p> <p>Amazon Warehouse Great Deals on Quality Used Products</p>	<p>Amazon Ads Reach customers wherever they spend their time</p> <p>Amazon Fresh Groceries & More Right To Your Door</p> <p>IMDb Movies, TV & Celebrities</p> <p>Whole Foods Market America's Healthiest Grocery Store</p>	<p>Spam Score deals on fashion brands</p> <p>Amazon Global Ship Orders Internationally</p> <p>IMDbPro Get Info Entertainment Professionals Need</p> <p>Woot! Deals and Shenanigans</p>	<p>AbeBooks books, art & collectibles</p> <p>Home Services Experienced Pros Happiness Guarantee</p> <p>Kindle Direct Publishing Indie Digital & Print Publishing Made Easy</p> <p>Zappos Shoes & Clothing</p>	<p>ACX Audiobook Publishing Made Easy</p> <p>Amazon Web Services Scalable Cloud Computing Services</p> <p>Amazon Photos Unlimited Photo Storage Free With Prime</p> <p>Ring Smart Home Security Systems</p>	<p>Sell on Amazon Start a Selling Account</p> <p>Audible Listen to Books & Original Audio Performances</p> <p>Prime Video Direct Video Distribution Made Easy</p> <p>eero WiFi Stream 4K Video in Every Room</p>	<p>Amazon Business Everything For Your Business</p> <p>Box Office Mojo Find Movie Box Office Data</p> <p>Shopbop Designer Fashion Brands</p> <p>Blink Smart Security for Every Home</p>
--	--	--	---	---	--	---

Neighbors
App
Real-Time
Crime
& Safety
Alerts

Amazon Subscription
Boxes
Top subscription boxes
— right to your door

PIIPack
Pharmacy
Simplified

Amazon
Renewed
Like new
products
you can trust

[Conditions of Use](#) [Privacy Notice](#) [Your Ads Privacy Choices](#)  

© 1996-2023, Amazon.com, Inc. or its affiliates

EXHIBIT Q
Mesiti Declaration
Infringing Product Type 1 Chart

THE CLOSEST COMPARATIVE DESIGNS, THE DESIGN CLAIMED IN THE '526 PATENT,
AND DEFENDANTS' INFRINGING PRODUCT TYPE 1











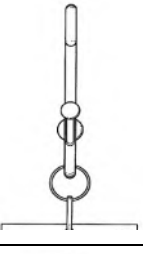

	'924 Design	'446 Design	Patented Design	Infringing Design Type 1
Front				
Back				
First Side				
Second Side				
Top				
Bottom				

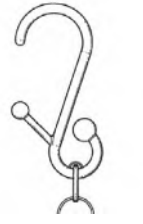
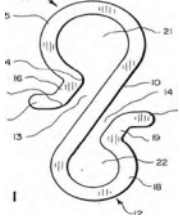
EXHIBIT R
Mesiti Declaration
Infringing Product Type 2 Chart

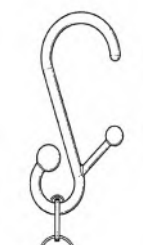
THE CLOSEST COMPARATIVE DESIGNS, THE DESIGN CLAIMED IN THE '526 PATENT,
AND DEFENDANTS' INFRINGING PRODUCT TYPE 2

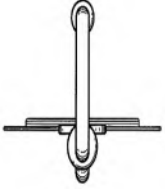
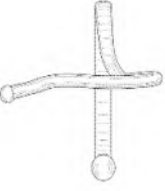

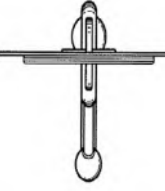







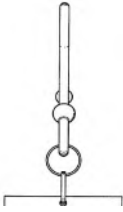



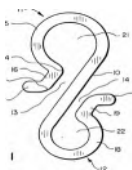

	'924 Design	'446 Design	Patented Design	Infringing Design Type 2
Front				
Back				
First Side				
Second Side				
Top				
Bottom				

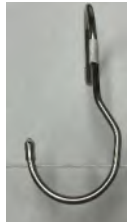
EXHIBIT S
Mesiti Declaration
Infringing Product Type 3 Chart

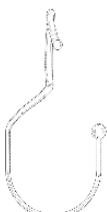
THE CLOSEST COMPARATIVE DESIGNS, THE DESIGN CLAIMED IN THE '526 PATENT,
AND DEFENDANTS' INFRINGING PRODUCT TYPE 3

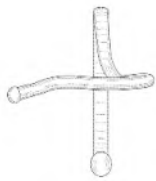

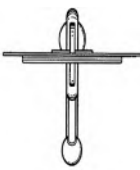







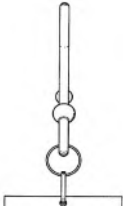





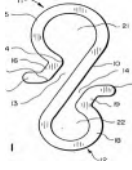

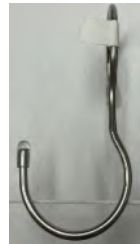

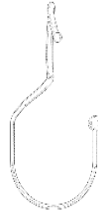

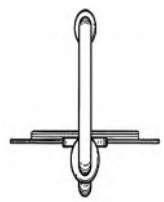
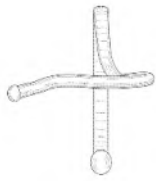

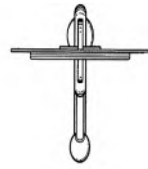

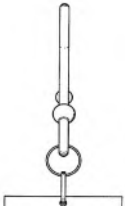

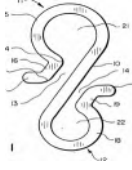

	'924 Design	'446 Design	Patented Design	Infringing Design Type 3
Front				
Back				
First Side				
Second Side				
Top				
Bottom				

EXHIBIT T
Mesiti Declaration
Infringing Product Type 4 Chart

THE CLOSEST COMPARATIVE DESIGNS, THE DESIGN CLAIMED IN THE '526 PATENT,
AND DEFENDANTS' INFRINGING PRODUCT TYPE 4

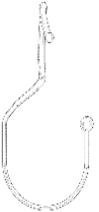
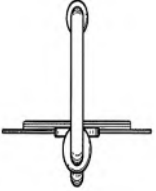
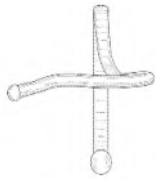
	'924 Design	'446 Design	Patented Design	Infringing Design Type 4
Front				
Back				
First Side				
Second Side				
Top				
Bottom	